

THIS DRAWING IS UNPUBLISHED. RELEASED FOR PUBLICATION  
 © COPYRIGHT - By - ALL RIGHTS RESERVED.

LOC		DIST		REVISIONS			
P	LTR	DESCRIPTION		DATE	DWN	APVD	
CM	00	C5		REVISED PER ECO-12-016924	08OCT12	KH	SM

POSITION 1 IDENTIFICATION FEATURE

- 1 MATERIAL: HOUSING-NYLON, UL94V-0 (COLOR-NATURAL, COLOR OF PARTS MAY VARY) CONTACTS-0.25 [.010] THICK BRASS ALLOY.
- 2 CONTACT FINISH: 0.002032 [.000080] MIN MATTE TIN OVER 0.000381 [.000015] MIN NICKEL OVER ENTIRE CONTACT.
- 3 MATES WITH VAL-U-LOK(TM) RECEPTACLE HOUSINGS.

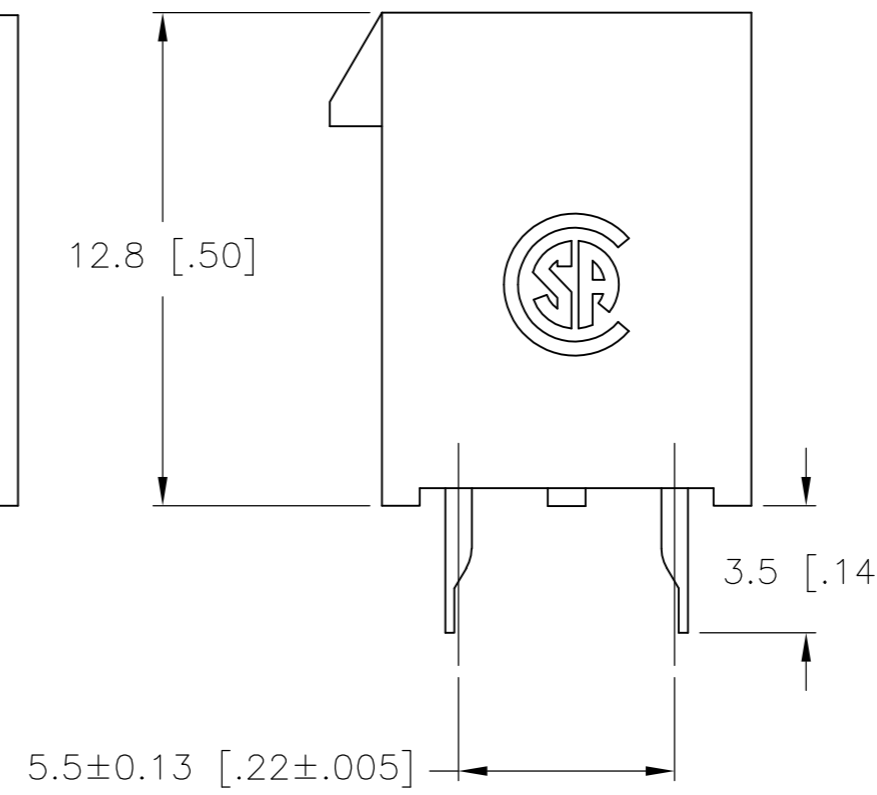
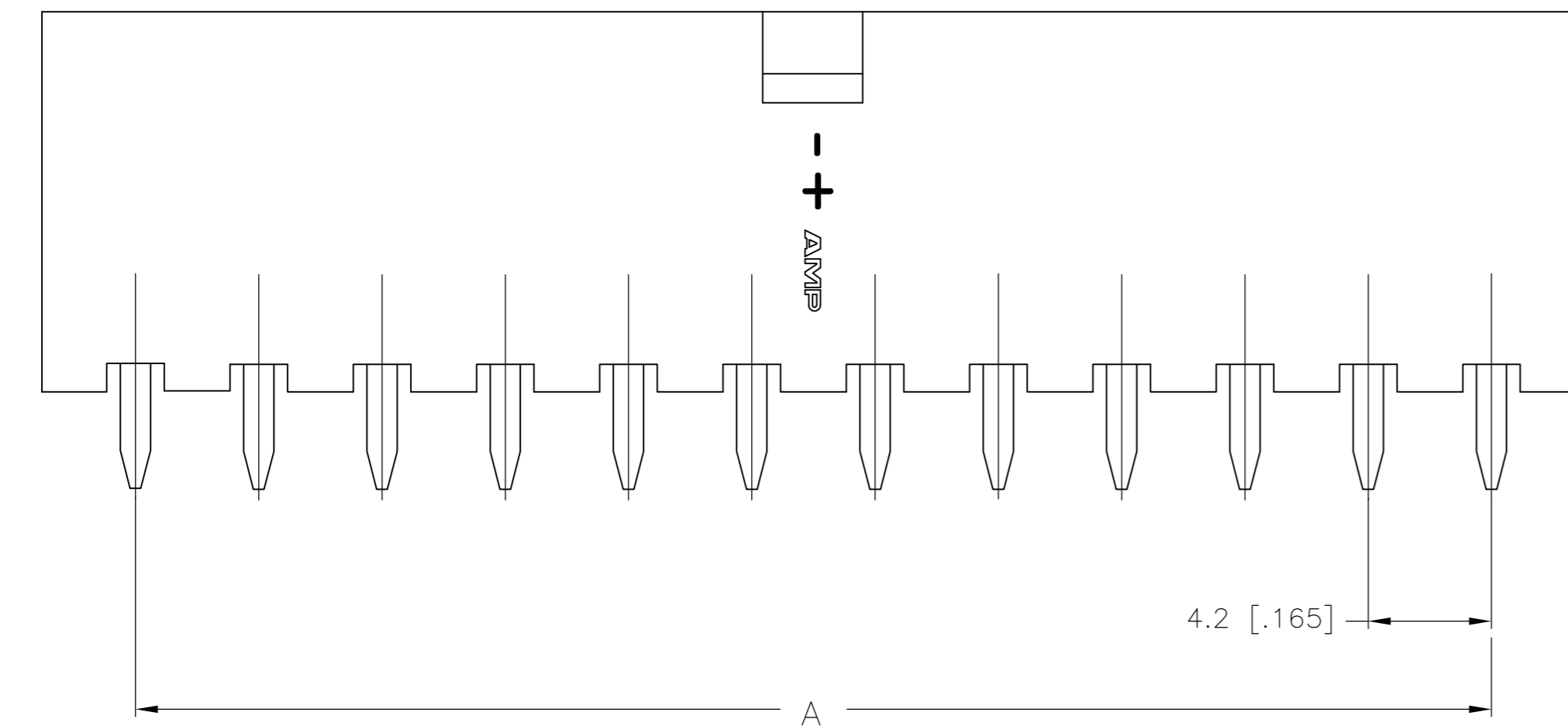
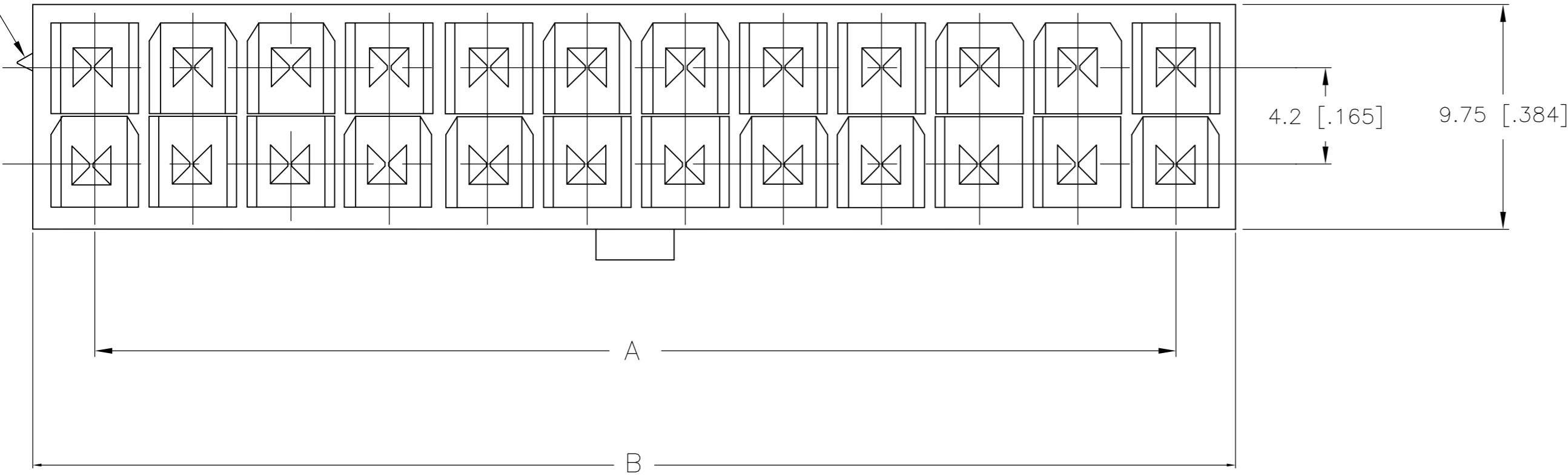

24	46.2±0.25 [1.82±.01]	51.6 [2.03]	2-1586038-4
22	42.0±0.25 [1.65±.01]	47.4 [1.87]	2-1586038-2
20	37.8±0.25 [1.49±.01]	43.2 [1.70]	2-1586038-0
18	33.6±0.25 [1.32±.01]	39.0 [1.54]	1-1586038-8
16	29.4±0.25 [1.16±.01]	34.8 [1.37]	1-1586038-6
14	25.2±0.25 [.99±.01]	30.6 [1.21]	1-1586038-4
12	21.0±0.25 [.83±.01]	26.4 [1.04]	1-1586038-2
10	16.8±0.13 [.66±.005]	22.2 [.87]	1-1586038-0
8	12.6±0.13 [.50±.005]	18.0 [.71]	1586038-8
6	8.4±0.13 [.33±.005]	13.8 [.54]	1586038-6
4	4.2±0.13 [.17±.005]	9.6 [.38]	1586038-4
2		5.4 [.21]	1586038-2
POS	A	B±0.25[.01]	PART NUMBER

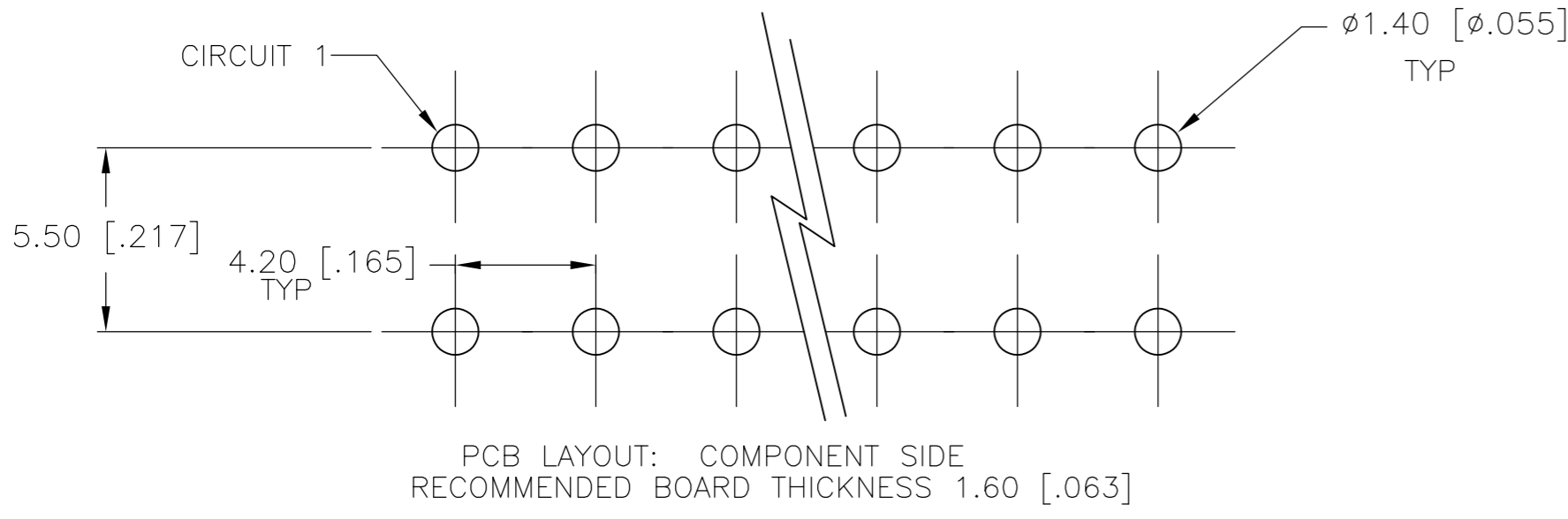

2-1586038-4 SHOWN

THIS DRAWING IS A CONTROLLED DOCUMENT.		DWN S. HOOVER 18-SEP-2002	TE Connectivity	
DIMENSIONS: mm [INCHES]		CHK D. COLEY 18-SEP-2002		
TOLERANCES UNLESS OTHERWISE SPECIFIED:		APVD D. COLEY 18-SEP-2002	NAME	
0 PLC ±		PRODUCT SPEC	WITH DRAIN HOLES VAL-U-LOK(TM)	
1 PLC ± 0.5 [.02]		APPLICATION SPEC	SIZE A2	CAGE CODE 00779
2 PLC ± 0.25 [.010]		WEIGHT	DRAWING NO C=1586038	RESTRICTED TO -
3 PLC ±		CUSTOMER DRAWING	SCALE 10:1	SHEET 1 of 1
4 PLC ±			REV C5	
ANGLES ±				
FINISH				

# Mouser Electronics

Authorized Distributor

Click to View Pricing, Inventory, Delivery & Lifecycle Information:

[TE Connectivity:](#)

[1-1586038-2](#)