

LOC	DIST	REVISIONS					
E	B	P	LTR	DESCRIPTION	DATE	DWN	APVD
			BA2	REVISED PER ECO-11-005150	29MAR2011	RK	HMR

FOR FURTHER INFORMATION SEE DATA SHEET FOR CPF SERIES-THIN FILM PRECISION CHIP RESISTORS

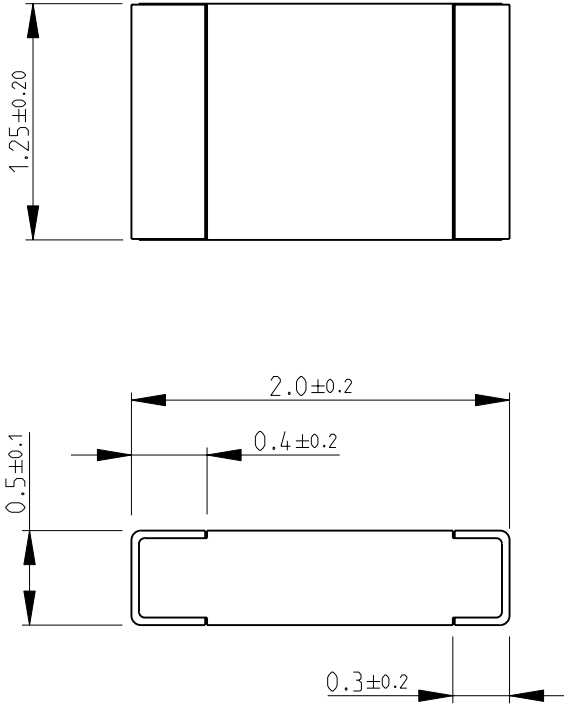

RoHS Compliant

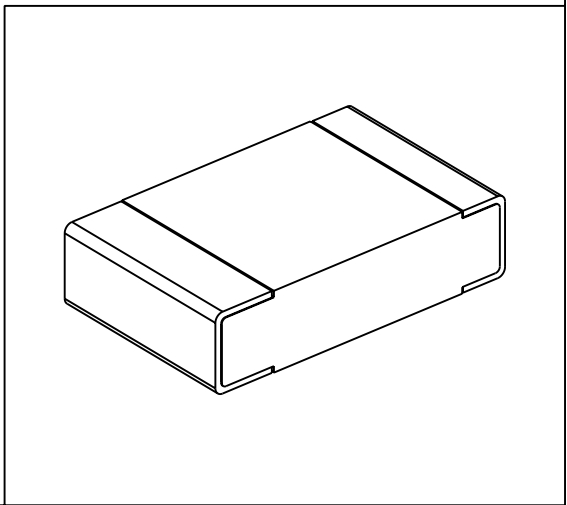

2008

RELEASED FOR PUBLICATION

ALL RIGHTS RESERVED.

THIS DRAWING IS UNPUBLISHED.

BY -
© COPYRIGHT 2008

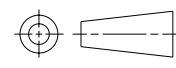
DIMENSIONS: mm	DWN	22-Sep-08	MATERIAL	-	FINISH	-
	CHK	22-Sep-08	 TE Connectivity			
TOLERANCES UNLESS OTHERWISE SPECIFIED:	APVD	22-Sep-08				
0 PLC ± 0.2	STEPHEN.P		NAME THIN FILM PRECISION CHIP RESISTORS SERIES CPF 0805			
1 PLC ± 0.1	PRODUCT SPEC	-				
2 PLC ± -	APPLICATION SPEC	-	SIZE	CAGE CODE	DRAWING NO	RESTRICTED TO
3 PLC ± -			A 4	00779	© = 1614884	-
4 PLC ± -			CUSTOMER DRAWING			
ANGLES ± 5°	WEIGHT	-	SCALE	25:1	SHEET	1 OF 1
			REV BA2			

Mouser Electronics

Authorized Distributor

Click to View Pricing, Inventory, Delivery & Lifecycle Information:

[TE Connectivity:](#)

[CPF0805B20RE1](#)