

Features

- +18 dBm Output Power
- -20 dBc Fundamental Leakage
- Lead-Free 3 mm 16-lead QFN Package
- 100% RF, DC and Output Power Testing
- RoHS* Compliant and 260°C Reflow Compatible

Description

The XX1000-QT is a 7.5-22.5/15.0-45.0 GHz SMD active doubler that delivers +18 dBm of output power. The device combines an active doubler with an output buffer amplifier that delivers constant power over a range of input powers. The device has excellent rejection of the fundamental and harmonic products.

This device uses MACOM's 0.15 GaAs pHEMT device model technology to ensure high reliability and uniformity. The device comes in a low-cost 3 mm QFN surface mount plastic package offering excellent RF and thermal properties and is RoHS compliant.

This device is well suited for Point-to-Point Radio, Microwave, LMDS, SATCOM and VSAT applications.

Functional Block Diagram

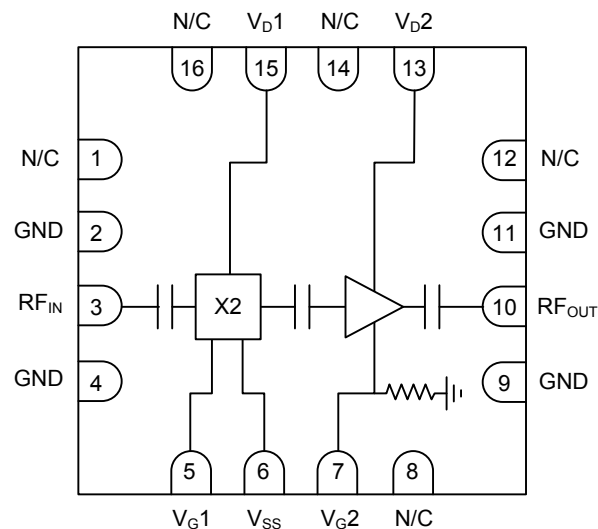

Pin Configuration¹

Pin #	Pin Name	Function
1,8,12,14,16	N/C	Not Connected
2,4,9,11	GND	Ground
3	RF _{IN}	RF Input
5	V _{G1}	Gate Voltage 1
6	V _{SS}	Source Voltage
7	V _{G2} ¹	Gate Voltage 2
10	RF _{OUT}	RF Output
13	V _{D2}	Drain Voltage 2
15	V _{D1}	Drain Voltage 1
17 ²	GND	Ground Pad

1. V_{G2} can be used for current regulating V_{D2} or V_{G2} can be set to GND with V_{D2} self-biasing at approximately 140 mA.
2. The exposed pad centered on the package bottom must be connected to RF, DC and thermal ground.

Ordering Information

Part Number	Package
XX1000-QT-0G00	bulk quantity
XX1000-QT-0G0T	tape and reel
XX1000-QT-EV1	evaluation module

¹ * Restrictions on Hazardous Substances, compliant to current RoHS EU directive.

Electrical Specifications: Input Frequency = 7.5 - 22.5 GHz, T_A = +25°C

Parameter	Units	Min.	Typ.	Max.
Output Frequency Range	GHz	15.0	-	45.0
Input Return Loss	dB	-	15.0	-
Output Return Loss	dB	-	7.0	-
Saturated Output Power	dBm	-	+18	-
RF Input Power	dBm	-10.0	-	+10.0
Fundamental Leakage	dBc	-	20	-
Third Harmonic Leakage	dBc	-	30	-
Fourth Harmonic Leakage	dBc	-	10	-
Drain Bias Voltage	VDC	-	+5.0	+5.5
Gate Bias Voltage 1	VDC	-0.8	-0.6	-0.4
Gate Bias Voltage 2	VDC	-1.2	0.0	+0.1
Supply Current (I _{D1,2}) (V _D = 5.0 V, V _{G1} = -0.6 V, V _{G2} = 0.0 V Typ.)	mA	-	220	250
Source Voltage	VDC	-5.5	-5.0	-2.0
Source Current	mA	25	50	60

Absolute Maximum Ratings³

Parameter	Absolute Max.
Supply Voltage	+6 V
Supply Voltage	-6 V
Supply Current	300 mA
Source Current	60 mA
Gate Bias Voltage	-0.4 V
Input Power	+15 dBm
Storage Temperature	-65°C to +165°C
Operating Temperature	-55°C to MTTF Table2
Channel Temperature	MTTF Table2

3. Channel temperature directly affects a device's MTTF. Channel temperature should be kept as low as possible to maximize lifetime.

Handling Procedures

Please observe the following precautions to avoid damage:

Static Sensitivity

Gallium Arsenide Integrated Circuits are sensitive to electrostatic discharge (ESD) and can be damaged by static electricity. Proper ESD control techniques should be used when handling these class 2 devices.

PCB Layout

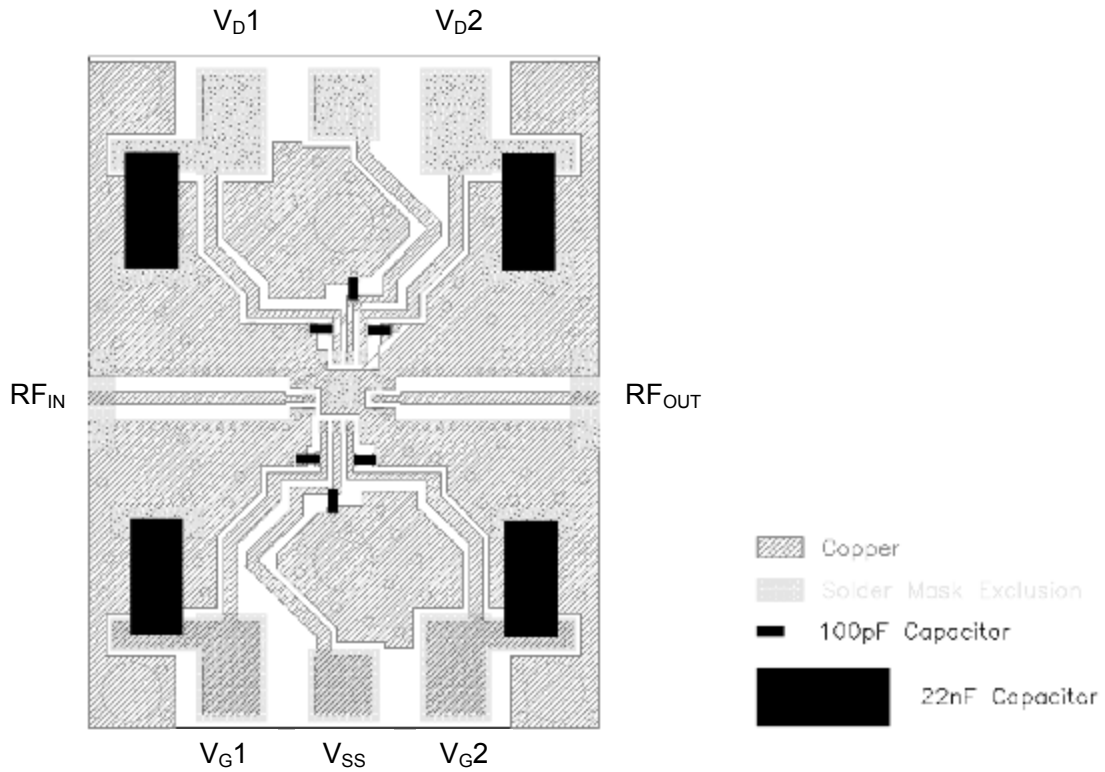

Typical Performance Curves: Nominal Bias Conditions

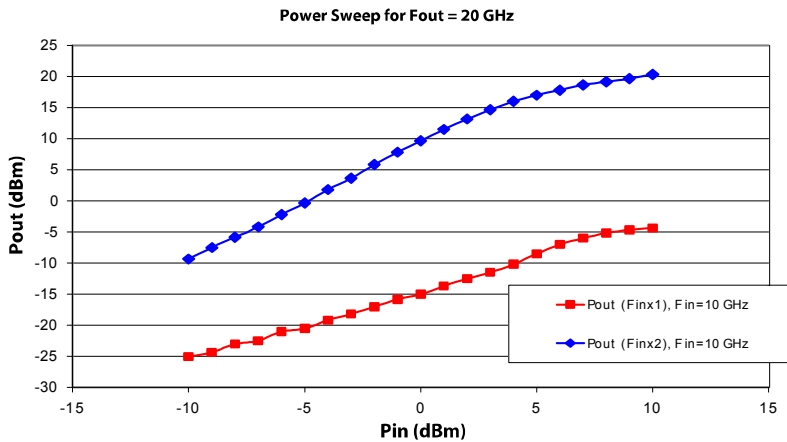
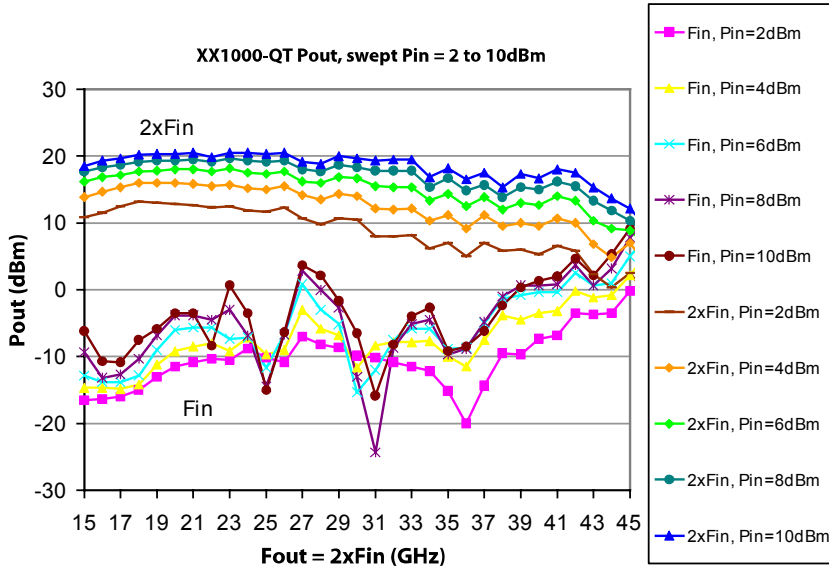

Measured results taken at room temperature in 40 GHz connectorized test fixture with no de-embedding.

Typical Performance Curves (cont.)

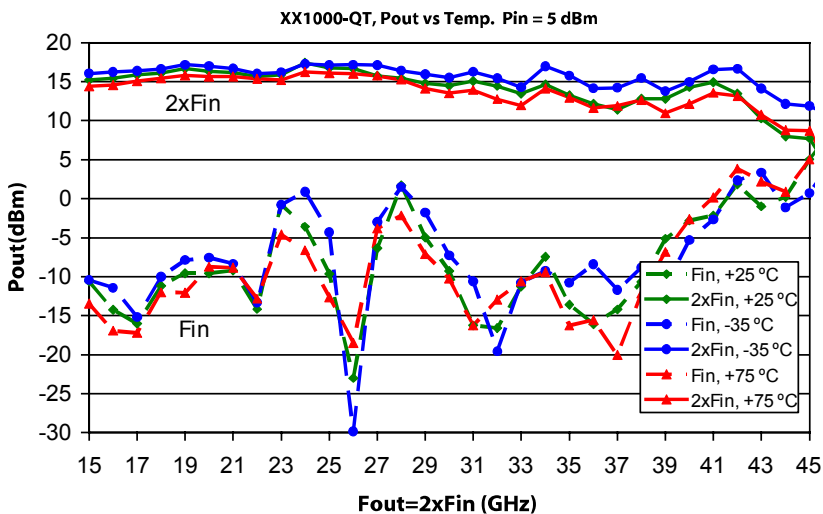
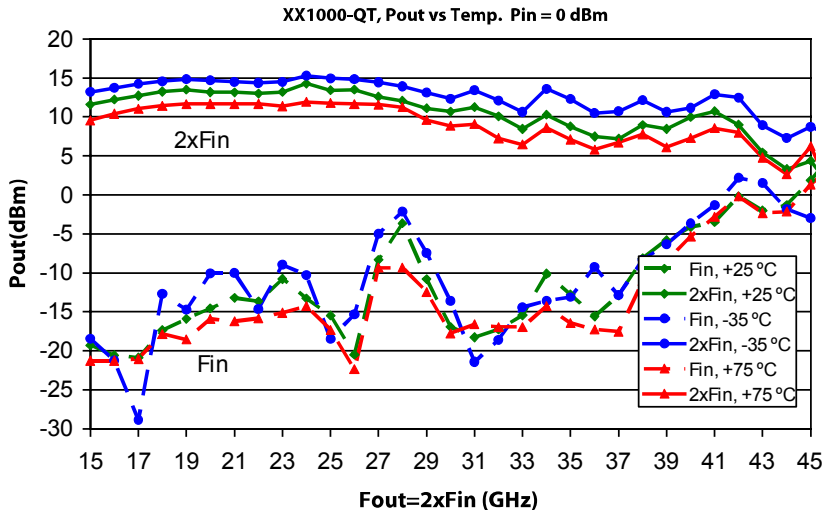

Typical Performance Curves (cont.)

Harmonic Products, Pin = +5 dBm (Fin = 6 - 20 GHz)

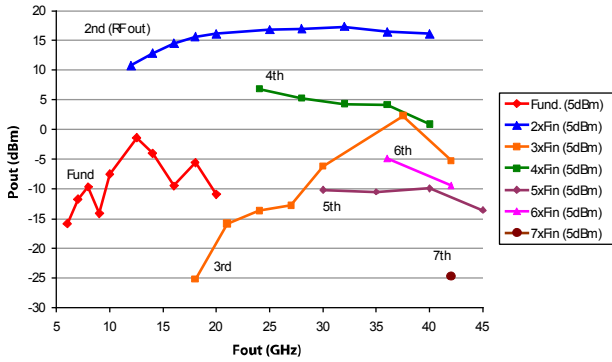

* Measured on-wafer with pre-packaging.

Harmonic Products, Pin = +0 dBm (Fin = 6 - 20 GHz)

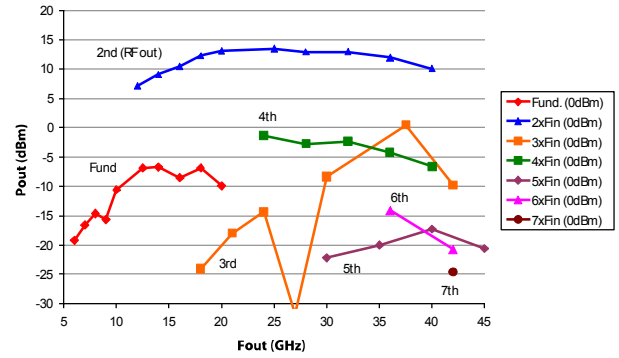

* Measured on-wafer with pre-packaging.

XX1000-QT: Input Return Loss (dB)

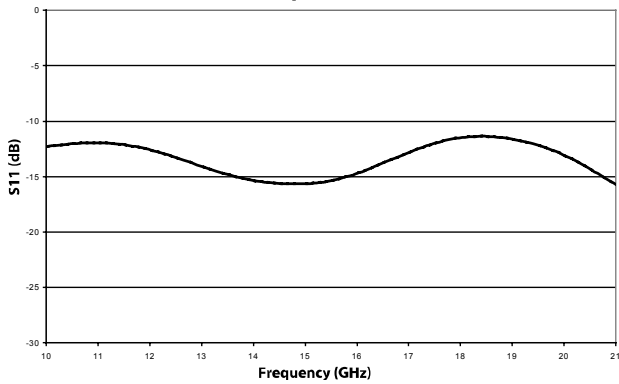

MTTF

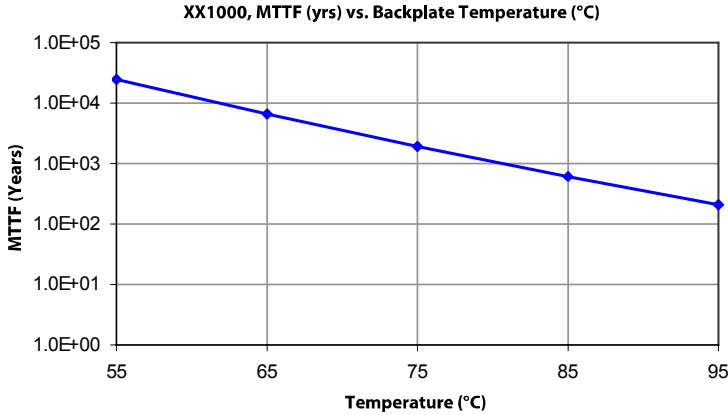

MTTF is calculated from accelerated life-time data of single devices and assumes isothermal back-plate.

Bias Conditions: $V_{D1,2} = 5\text{ V}$, $I_{D1,2} = 220\text{ mA}$, $V_{SS} = -5\text{ V}$, $I_{SS} = 50\text{ mA}$

App Note [1] Biasing -

It is recommended to separately bias each doubler stage with fixed voltages of $V_{D(1,2)} = 5\text{ V}$, $V_{SS} = -5\text{ V}$ and $V_{G1} = -0.6\text{ V}$. The typical DC currents are $I_{D1} = 80\text{ mA}$, $I_{D2} = 140\text{ mA}$ and $I_{SS} = 50\text{ mA}$. V_{G2} can be used for active control biasing of V_{D2} , or it can be set to GND and V_{D2} will self bias at approximately 140 mA. Maximum output power is achieved with $V_{SS} = -5\text{ V}$ and $I_{SS} = 50\text{ mA}$ but the device will operate with reduced bias to $V_{SS} = -2\text{ V}$ and $I_{SS} = 25\text{ mA}$. It is also recommended to use active biasing on V_{D2} with V_{G2} to keep the currents constant as the RF power and temperature vary; this gives the most reproducible results. Depending on the supply voltage available and the power dissipation constraints, the bias circuit may be a single transistor or a low power operational amplifier, with a low value resistor in series with the drain supply used to sense the current. The gate of the pHEMT is controlled to maintain correct drain current and thus drain voltage. The typical gate voltage for $V_{G2} = -0.1\text{ V}$. Typically the gate is protected with silicon diodes to limit the applied voltage. Also, make sure to sequence the applied voltage to ensure negative gate bias is available before applying the positive drain supply.

Active Doubler
7.5 - 22.5 / 15.0 - 45.0 GHz

Rev. V4

Lead-Free Package Dimensions/Layout

QT (3x3 mm)

Pin 1 Dot
By marking

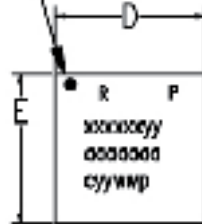

TOP VIEW

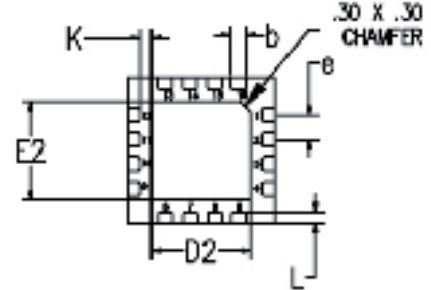
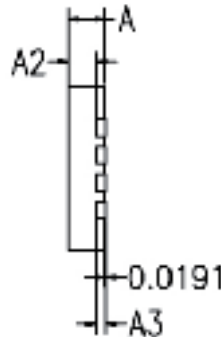

BOTTOM VIEW

Note:

1. ALL DIMENSIONS ARE IN mm.

MARKINGS:
PIN 1/DOT REF/PLACING
MINI PART/MODEL NO.
WAFER LOT NUMBER
DATE CODE

RECOMMENDED SOLDER PAD PITCH AND DIMENSIONS

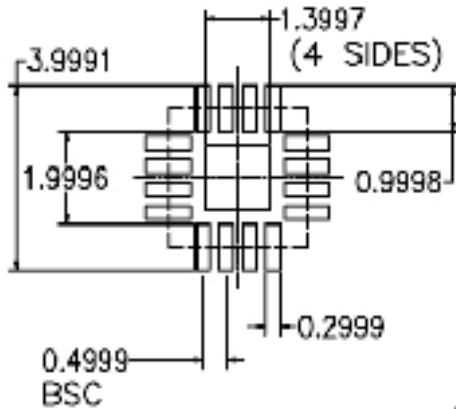

	MIN	TYP	MAX
A	0.80	0.90	1.00
A3	0.20 REF		
A2	0.00	0.65	1.00
b	0.20	0.25	0.30
K	0.20	-	-
D	3.00 BSC		
E	3.00 BSC		
e	0.50		
D2	1.50	1.65	1.80
E2	1.50	1.65	1.80
L	0.16	0.26	0.36

1. VIEWS ARE NOT TO SCALE: USE DIMENSIONS AND TABLE.

MACOM Technology Solutions Inc. All rights reserved.

Information in this document is provided in connection with MACOM Technology Solutions Inc ("MACOM") products. These materials are provided by MACOM as a service to its customers and may be used for informational purposes only. Except as provided in MACOM's Terms and Conditions of Sale for such products or in any separate agreement related to this document, MACOM assumes no liability whatsoever. MACOM assumes no responsibility for errors or omissions in these materials. MACOM may make changes to specifications and product descriptions at any time, without notice. MACOM makes no commitment to update the information and shall have no responsibility whatsoever for conflicts or incompatibilities arising from future changes to its specifications and product descriptions. No license, express or implied, by estoppel or otherwise, to any intellectual property rights is granted by this document.

THESE MATERIALS ARE PROVIDED "AS IS" WITHOUT WARRANTY OF ANY KIND, EITHER EXPRESS OR IMPLIED, RELATING TO SALE AND/OR USE OF MACOM PRODUCTS INCLUDING LIABILITY OR WARRANTIES RELATING TO FITNESS FOR A PARTICULAR PURPOSE, CONSEQUENTIAL OR INCIDENTAL DAMAGES, MERCHANTABILITY, OR INFRINGEMENT OF ANY PATENT, COPYRIGHT OR OTHER INTELLECTUAL PROPERTY RIGHT. MACOM FURTHER DOES NOT WARRANT THE ACCURACY OR COMPLETENESS OF THE INFORMATION, TEXT, GRAPHICS OR OTHER ITEMS CONTAINED WITHIN THESE MATERIALS. MACOM SHALL NOT BE LIABLE FOR ANY SPECIAL, INDIRECT, INCIDENTAL, OR CONSEQUENTIAL DAMAGES, INCLUDING WITHOUT LIMITATION, LOST REVENUES OR LOST PROFITS, WHICH MAY RESULT FROM THE USE OF THESE MATERIALS.

MACOM products are not intended for use in medical, lifesaving or life sustaining applications. MACOM customers using or selling MACOM products for use in such applications do so at their own risk and agree to fully indemnify MACOM for any damages resulting from such improper use or sale.