

PCB terminal block - PTSM 0,5/ 4-2,5-V THR R44 - 1770979

Please be informed that the data shown in this PDF Document is generated from our Online Catalog. Please find the complete data in the user's documentation. Our General Terms of Use for Downloads are valid (<http://phoenixcontact.com/download>)



PCB terminal block, nominal current: 6 A, nom. voltage: 160 V, pitch: 2.5 mm, number of positions: 4, connection method: Push-in spring connection, mounting: THR soldering, conductor/PCB connection direction: 90 °, color: black

The figure shows a 3-position version

Your advantages

- ✓ Time saving push-in connection, tools not required
- ✓ Defined contact force ensures that contact remains stable over the long term
- ✓ High current carrying capacity of 6 A in very compact dimensions
- ✓ Designed for integration into the SMT soldering process
- ✓ Vertical connection enables multi-row arrangement on the PCB



Key Commercial Data

Packing unit	310 pc
Minimum order quantity	310 pc
GTIN	
GTIN	4046356459556

Technical data

Dimensions

Length [l]	5 mm
Pitch	2.5 mm
Dimension a	7.5 mm
Width [w]	10.5 mm
Height	10 mm
Height [h]	12.1 mm
Solder pin [P]	2.1 mm
Pin spacing	2.5 mm
Hole diameter	1.2 mm

PCB terminal block - PTSM 0,5/ 4-2,5-V THR R44 - 1770979

Technical data

General

Range of articles	PTSM 0,5/..-V-THR
Insulating material group	IIIa
Rated surge voltage (III/3)	2.5 kV
Rated surge voltage (III/2)	2.5 kV
Rated surge voltage (II/2)	2.5 kV
Rated voltage (III/3)	63 V
Rated voltage (III/2)	160 V
Rated voltage (II/2)	200 V
Connection in acc. with standard	EN-VDE
Nominal current I _N	6 A
Nominal cross section	0.5 mm ²
Maximum load current	6 A
Insulating material	LCP
Flammability rating according to UL 94	V0
Stripping length	6 mm
Number of positions	4

Connection data

Conductor cross section solid min.	0.14 mm ²
Conductor cross section solid max.	0.5 mm ²
Conductor cross section flexible min.	0.2 mm ²
Conductor cross section flexible max.	0.5 mm ²
Conductor cross section flexible, with ferrule without plastic sleeve min.	0.25 mm ²
Conductor cross section flexible, with ferrule without plastic sleeve max.	0.5 mm ²
Conductor cross section flexible, with ferrule with plastic sleeve min.	0.25 mm ²
Conductor cross section flexible, with ferrule with plastic sleeve max.	0.34 mm ²
Conductor cross section AWG min.	26
Conductor cross section AWG max.	20

Standards and Regulations

Connection in acc. with standard	EN-VDE
	UL
Flammability rating according to UL 94	V0

Environmental Product Compliance

China RoHS	Environmentally friendly use period: unlimited = EFUP-e
	No hazardous substances above threshold values

Drawings

PCB terminal block - PTSM 0,5/ 4-2,5-V THR R44 - 1770979

Drilling diagram

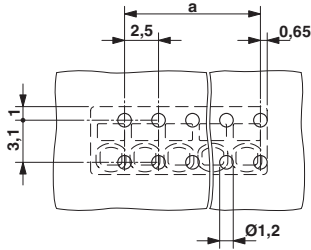

Diagram

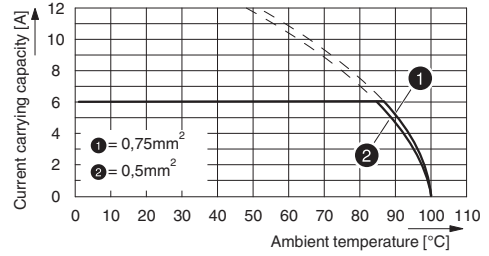

Type: PTSM 0,5/...-2,5-V THR R44
 Tested according to DIN EN 60512-5-2:2003-01
 Reduction factor = 1
 Number of positions: 5

Dimensional drawing

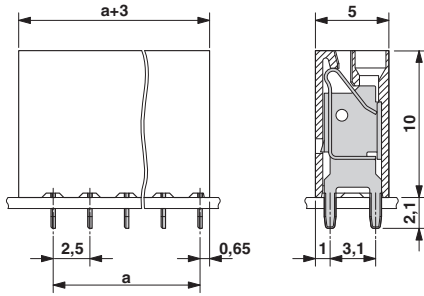

Dimensional drawing

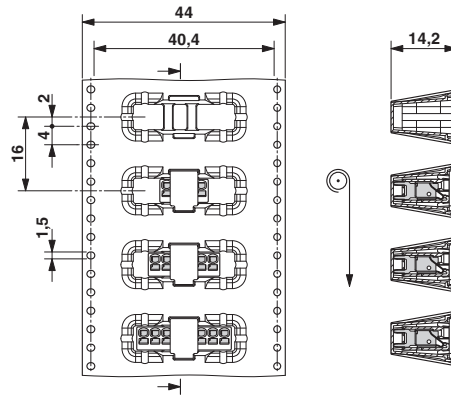

Approvals

Approvals

Approvals

UL Recognized / VDE Zeichengenehmigung / EAC / cULus Recognized

Ex Approvals

Approval details

UL Recognized		http://database.ul.com/cgi-bin/XYV/template/LISEXT/1FRAME/index.htm E118976-20130619
		B
Nominal voltage UN		150 V
Nominal current IN		5 A

PCB terminal block - PTSM 0,5/ 4-2,5-V THR R44 - 1770979

Approvals

	B
mm ² /AWG/kcmil	26-18

VDE Zeichengenehmigung		http://www2.vde.com/de/Institut/Online-Service/VDE-gepruefteProdukte/Seiten/Online-Suche.aspx	40048725
------------------------	---	---	----------

EAC		B.01742
-----	---	---------

cULus Recognized		http://database.ul.com/cgi-bin/XYV/template/LISEXT/1FRAME/index.htm	E60425-20030527
	B		
Nominal voltage UN	150 V		
Nominal current IN	5 A		
mm ² /AWG/kcmil	26-20		

Phoenix Contact 2018 © - all rights reserved
<http://www.phoenixcontact.com>

PHOENIX CONTACT GmbH & Co. KG
 Flachsmarktstr. 8
 32825 Blomberg
 Germany
 Tel. +49 5235 300
 Fax +49 5235 3 41200
<http://www.phoenixcontact.com>

Mouser Electronics

Authorized Distributor

Click to View Pricing, Inventory, Delivery & Lifecycle Information:

[Phoenix Contact:](#)

[1770979](#)