

LP3996 Dual Linear Regulator with 300 mA and 150 mA Outputs and Power-On-Reset

Check for Samples: [LP3996](#)

FEATURES

- 2 LDO Outputs with Independent Enable
- 1.5% Accuracy at Room Temperature, 3% Over Temperature
- Power-On-Reset Function with Adjustable Delay
- Thermal Shutdown Protection
- Stable with Ceramic Capacitors

KEY SPECIFICATIONS

- Input Voltage Range 2.0V to 6.0V
- Low Dropout Voltage 210 mV at 300 mA
- Ultra-Low I_Q (Enabled) 35 μ A
- Virtually Zero I_Q (Disabled) <10 nA
- Package Available in Lead-Free Option
10-pin 3 mm x 3 mm

APPLICATIONS

- Cellular Handsets
- PDAs
- Wireless Network Adaptors

DESCRIPTION

The LP3996 is a dual low dropout regulator with power-on-reset circuit. The first regulator can source 150 mA, while the second is capable of sourcing 300 mA and has a power-on-reset function included.

The LP3996 provides 1.5% accuracy requiring an ultra low quiescent current of 35 μ A. Separate enable pins allow each output of the LP3996 to be shut down, drawing virtually zero current.

The LP3996 is designed to be stable with small footprint ceramic capacitors down to 1 μ F. An external capacitor may be used to set the POR delay time as required.

The LP3996 is available in fixed output voltages and comes in a 10-pin, 3 mm x 3 mm package.

Typical Application Circuit

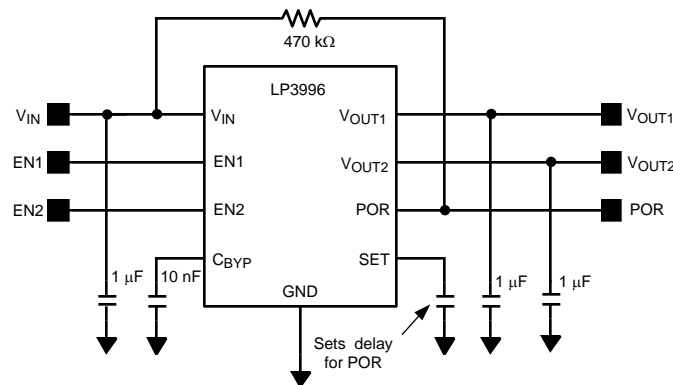

Please be aware that an important notice concerning availability, standard warranty, and use in critical applications of Texas Instruments semiconductor products and disclaimers thereto appears at the end of this data sheet.

All trademarks are the property of their respective owners.

Functional Block Diagram

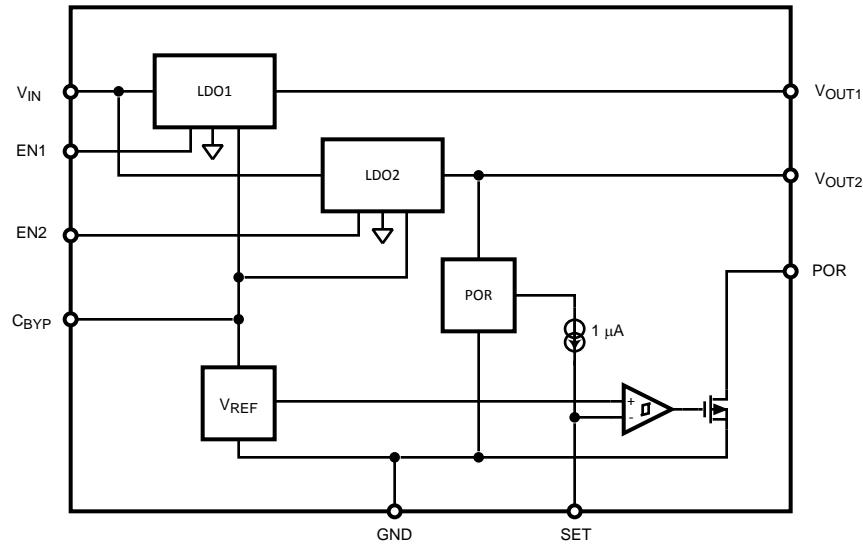

Pin Functions

Pin No	Symbol	Name and Function
1	V _{IN}	Voltage Supply Input. Connect a 1 μF capacitor between this pin and GND.
2	EN1	Enable Input to Regulator 1. Active high input. High = On. Low = OFF.
3	EN2	Enable Input to Regulator 2. Active high input. High = On. Low = OFF.
4	C _{BYP}	Internal Voltage Reference Bypass. Connect a 10nF capacitor from this pin to GND to reduce output noise and improve line transient and PSRR. This pin may be left open.
5	SET	Set Delay Input. Connect a capacitor between this pin and GND to set the POR delay time. If left open, there will be no delay.
6	GND	Common Ground pin. Connect externally to exposed pad.
7	N/C	No Connection. Do not connect to any other pin.
8	POR	Power-On Reset Output. Open drain output. Active low indicates under-voltage output on Regulator 2. A pull-up resistor is required for correct operation.
9	V _{OUT2}	Output of Regulator 2. 300 mA maximum current output. Connect a 1 μF capacitor between this pin and GND.
10	V _{OUT1}	Output of Regulator 1. 150 mA maximum current output. Connect a 1 μF capacitor between this pin and GND.
Pad	GND	Common Ground. Connect to Pin 6.

Connection Diagram

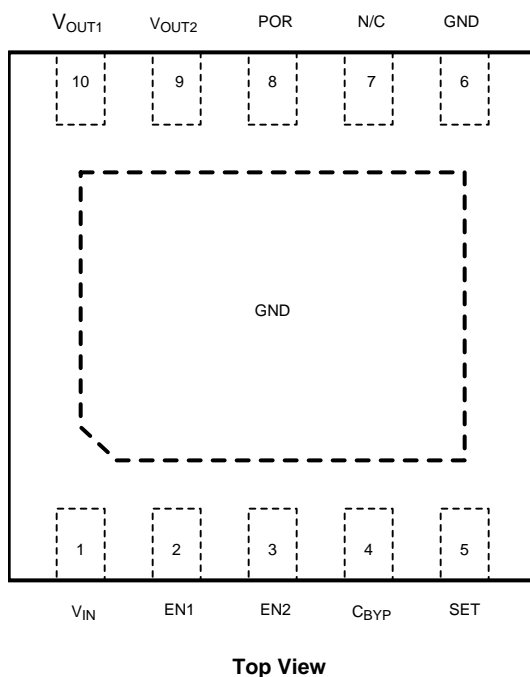

Figure 1. WSON-10 Package
See Package Number DSC0010A

Table 1. Additional Device Information ⁽¹⁾

VOUT1/VOUT2 (V)	ORDER NUMBER
0.8/3.3	LP3996SD/X-0833/NOPB
1.0/1.8	LP3996SD/X-1018/NOPB
1.5/2.5	LP3996SD/X-1525/NOPB
1.8/3.3	LP3996SD/X-1833/NOPB
2.5/3.3	LP3996SD/X-2533/NOPB
2.8/2.8	LP3996SD/X-2828/NOPB
3.0/3.0	LP3996SD/X-3030/NOPB
3.0/3.3	LP3996SD/X-3033/NOPB
3.3/0.8	LP3996SD/X-3308/NOPB
3.3/3.3	LP3996SD/X-3333/NOPB

(1) For the most current package and ordering information, see the Package Option Addendum at the end of this document, or see the TI web site at www.ti.com.



These devices have limited built-in ESD protection. The leads should be shorted together or the device placed in conductive foam during storage or handling to prevent electrostatic damage to the MOS gates.

ABSOLUTE MAXIMUM RATINGS⁽¹⁾⁽²⁾

Input Voltage to GND	–0.3V to 6.5V	
V _{OUT1} , V _{OUT2} EN1 and EN2 Voltage to GND	–0.3V to (V _{IN} + 0.3V) with 6.5V (max)	
POR to GND	–0.3V to 6.5V	
Junction Temperature (T _{J-MAX})	150°C	
Lead/Pad Temp ⁽³⁾	235°C	
Storage Temperature	–65°C to 150°C	
Continuous Power Dissipation Internally Limited ⁽⁴⁾		
ESD Rating ⁽⁵⁾	Human Body Model	2.0kV
	Machine Model	200V

- (1) All Voltages are with respect to the potential at the GND pin.
- (2) Absolute Maximum Ratings are limits beyond which damage can occur. Recommended Operating Conditions are conditions under which operation of the device is ensured. Recommended Operating Conditions do not imply ensured performance limits. For ensured performance limits and associated test conditions, see the Electrical Characteristics tables.
- (3) For detailed soldering specifications and information, please refer to Texas Instruments [Application Note AN-1187](#), Leadless Leadframe Package.
- (4) Internal thermal shutdown circuitry protects the device from permanent damage.
- (5) The human body model is 100 pF discharged through a 1.5 kΩ resistor into each pin. The machine model is a 200 pF capacitor discharged directly into each pin.

RECOMMENDED OPERATING CONDITIONS⁽¹⁾⁽²⁾

Input Voltage	2.0V to 6.0V
EN1, EN2, POR Voltage	0 to (V _{IN} + 0.3V) to 6.0V (max)
Junction Temperature	–40°C to 125°C
Ambient Temperature T _A Range ⁽³⁾	–40°C to 85°C

- (1) Absolute Maximum Ratings are limits beyond which damage can occur. Recommended Operating Conditions are conditions under which operation of the device is ensured. Recommended Operating Conditions do not imply ensured performance limits. For ensured performance limits and associated test conditions, see the Electrical Characteristics tables.
- (2) All Voltages are with respect to the potential at the GND pin.
- (3) The maximum ambient temperature (T_{A(max)}) is dependant on the maximum operating junction temperature (T_{J(max-op)} = 125°C), the maximum power dissipation of the device in the application (P_{D(max)}), and the junction to ambient thermal resistance of the part/package in the application (θ_{JA}), as given by the following equation: T_{A(max)} = T_{J(max-op)} - (θ_{JA} × P_{D(max)}).

THERMAL PROPERTIES⁽¹⁾

Junction-To-Ambient Thermal Resistance ⁽²⁾	
θ _{JA} WSON-10 Package	55°C/W

- (1) Absolute Maximum Ratings are limits beyond which damage can occur. Recommended Operating Conditions are conditions under which operation of the device is ensured. Recommended Operating Conditions do not imply ensured performance limits. For ensured performance limits and associated test conditions, see the Electrical Characteristics tables.
- (2) Junction-to-ambient thermal resistance is dependant on the application and board layout. In applications where high maximum power dissipation is possible; special care must be paid to thermal dissipation issues in board design.

ELECTRICAL CHARACTERISTICS⁽¹⁾⁽²⁾

Unless otherwise noted, $V_{EN} = 950\text{ mV}$, $V_{IN} = V_{OUT} + 1.0\text{V}$, or 2.0V , whichever is higher, where V_{OUT} is the higher of V_{OUT1} and V_{OUT2} . $C_{IN} = 1\ \mu\text{F}$, $I_{OUT} = 1\ \text{mA}$, $C_{OUT1} = C_{OUT2} = 1.0\ \mu\text{F}$.

Typical values and limits appearing in normal type apply for $T_A = 25^\circ\text{C}$. Limits appearing in **boldface** type apply over the full junction temperature range for operation, -40 to $+125^\circ\text{C}$.

SYMBOL	PARAMETER	CONDITIONS	TYP	LIMIT		UNITS
				MIN	MAX	
V_{IN}	Input Voltage	See ⁽³⁾		2	6	V
ΔV_{OUT}	Output Voltage Tolerance	$I_{OUT} = 1\ \text{mA}$ $1.5\text{V} < V_{OUT} \leq 3.3\text{V}$		-2.5 -3.75	+2.5 +3.75	%
				-2.75 -4	+2.75 +4	
	Line Regulation Error	$V_{IN} = (V_{OUT(NOM)} + 1.0\text{V})$ to 6.0V	0.03		0.3	%/V
	Load Regulation Error	$I_{OUT} = 1\ \text{mA}$ to $150\ \text{mA}$ (LDO 1)	85		155	$\mu\text{V}/\text{mA}$
$I_{OUT} = 1\ \text{mA}$ to $300\ \text{mA}$ (LDO 2)		26		85		
V_{DO}	Dropout Voltage ⁽⁴⁾	$I_{OUT} = 1\ \text{mA}$ to $150\ \text{mA}$ (LDO 1)	110		220	mV
		$I_{OUT} = 1\ \text{mA}$ to $300\ \text{mA}$ (LDO 2)	210		550	
I_Q	Quiescent Current	LDO 1 ON, LDO 2 ON $I_{OUT1} = I_{OUT2} = 0\ \text{mA}$	35		100	μA
		LDO 1 ON, LDO 2 OFF $I_{OUT1} = 150\ \text{mA}$	45		110	
		LDO 1 OFF, LDO 2 ON $I_{OUT2} = 300\ \text{mA}$	45		110	
		LDO 1 ON, LDO 2 ON $I_{OUT1} = 150\ \text{mA}$, $I_{OUT2} = 300\ \text{mA}$	70		170	
		$V_{EN1} = V_{EN2} = 0.4\text{V}$	0.5		10	nA

(1) All Voltages are with respect to the potential at the GND pin.

(2) Min and Max limits are specified by design, test or statistical analysis. Typical numbers are not ensured, but do represent the most likely norm.

(3) $V_{IN(MIN)} = V_{OUT(NOM)} + 0.5\text{V}$, or 2.0V , whichever is higher.

(4) Dropout voltage is voltage difference between input and output at which the output voltage drops to $100\ \text{mV}$ below its nominal value. This parameter only for output voltages above 2.0V

ELECTRICAL CHARACTERISTICS⁽¹⁾⁽²⁾ (continued)

Unless otherwise noted, $V_{EN} = 950\text{ mV}$, $V_{IN} = V_{OUT} + 1.0\text{V}$, or 2.0V , whichever is higher, where V_{OUT} is the higher of V_{OUT1} and V_{OUT2} . $C_{IN} = 1\ \mu\text{F}$, $I_{OUT} = 1\ \text{mA}$, $C_{OUT1} = C_{OUT2} = 1.0\ \mu\text{F}$.

Typical values and limits appearing in normal type apply for $T_A = 25^\circ\text{C}$. Limits appearing in **boldface** type apply over the full junction temperature range for operation, -40 to $+125^\circ\text{C}$.

SYMBOL	PARAMETER	CONDITIONS	TYP	LIMIT		UNITS
				MIN	MAX	
I_{SC}	Short Circuit Current Limit	LDO 1	420		750	mA
		LDO 2	550		840	
I_{OUT}	Maximum Output Current	LDO 1		150		mA
		LDO 2		300		
PSRR	Power Supply Rejection Ratio ⁽⁵⁾	f = 1kHz, $I_{OUT} = 1\text{mA to }150\text{ mA}$ $C_{BYP} = 10\ \text{nF}$	LDO1	58		dB
			LDO2	70		
		f = 20 kHz, $I_{OUT} = 1\text{mA to }150\text{ mA}$ $C_{BYP} = 10\ \text{nF}$	LDO1	45		
			LDO2	60		
e_n	Output noise Voltage ⁽⁵⁾	BW = 10 Hz to 100kHz $C_{BYP} = 10\ \text{nF}$	$V_{OUT} = 0.8\text{V}$	36		μV_{RMS}
			$V_{OUT} = 3.3\text{V}$	75		
$T_{SHUTDOWN}$	Thermal Shutdown	Temperature	160			$^\circ\text{C}$
		Hysteresis	20			
Enable Control Characteristics						
I_{EN}	Input Current at V_{EN1} or V_{EN2}	$V_{EN} = 0.0\text{V}$	0.005		0.1	μA
		$V_{EN} = 6\text{V}$	2		5	
V_{IL}	Low Input Threshold at V_{EN1} or V_{EN2}				0.4	V
V_{IH}	High Input Threshold at V_{EN1} or V_{EN2}			0.95		V
POR Output Characteristics						
V_{TH}	Low Threshold % Of V_{OUT2} (NOM)	Flag ON		88		%
	High Threshold % Of V_{OUT2} (NOM)	Flag OFF			96	
I_{POR}	Leakage Current	Flag OFF, $V_{POR} = 6.5\text{V}$	30			nA
V_{OL}	Flag Output Low Voltage	$I_{SINK} = 250\ \mu\text{A}$	20			mV
Timing Characteristics						
T_{ON}	Turn On Time ⁽⁵⁾	To 95% Level $C_{BYP} = 10\ \text{nF}$	300			μs
Transient Response	Line Transient Response $ \delta V_{OUT} ^{(5)}$	$T_{rise} = T_{fall} = 10\ \mu\text{s}$ $\delta V_{IN} = 1\text{V}$, $C_{BYP} = 10\ \text{nF}$	20			mV (pk - pk)
	Load Transient Response $ \delta V_{OUT} ^{(5)}$	$T_{rise} = T_{fall} = 1\ \mu\text{s}$	LDO 1 $I_{OUT} = 1\ \text{mA to }150\ \text{mA}$	175		
			LDO 2 $I_{OUT} = 1\ \text{mA to }300\ \text{mA}$	150		
SET Input Characteristics						
I_{SET}	SET Pin Current Source	$V_{SET} = 0\text{V}$	1.3			μA
$V_{TH(SET)}$	SET Pin Threshold Voltage	POR = High	1.25			V

(5) This electrical specification is specified by design.

OUTPUT CAPACITOR, RECOMMENDED SPECIFICATIONS

SYMBOL	PARAMETER	CONDITIONS	NOM	LIMIT		UNITS
				MIN	MAX	
C _{OUT}	Output Capacitance	Capacitance ⁽¹⁾	1.0	0.7	500	μF
		ESR				

(1) The Capacitor tolerance should be 30% or better over temperature. The full operating conditions for the application should be considered when selecting a suitable capacitor to ensure that the minimum value of capacitance is always met. Recommended capacitor is X7R. However, depending on the application, X5R, Y5V and Z5U can also be used. (See Capacitor sections in [APPLICATION HINTS](#).)

Transient Test Conditions

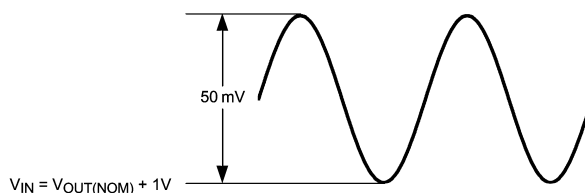

Figure 2. PSRR Input Signal

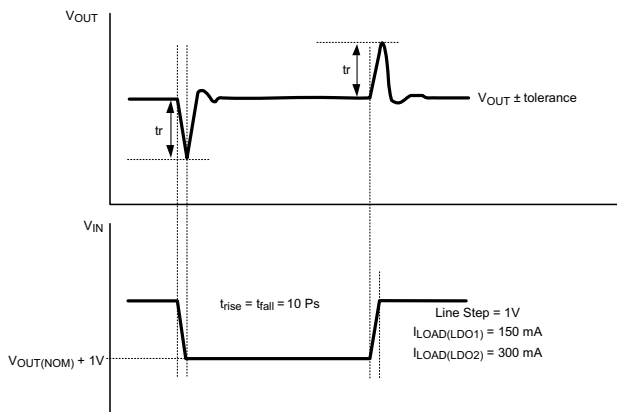

Figure 3. Line Transient Input Test Signal

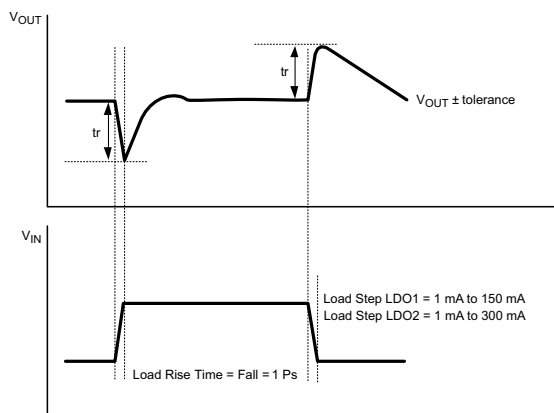

Figure 4. Load Transient Input Signal

TYPICAL PERFORMANCE CHARACTERISTICS

Unless otherwise specified, $C_{IN} = 1.0 \mu F$ Ceramic, $C_{OUT1} = C_{OUT2} = 1.0 \mu F$ Ceramic, $C_{BYP} = 10 \text{ nF}$, $V_{IN} = V_{OUT2(NOM)} + 1.0V$, $T_A = 25^\circ C$, $V_{OUT1(NOM)} = 3.3V$, $V_{OUT2(NOM)} = 3.3V$, Enable pins are tied to V_{IN} .

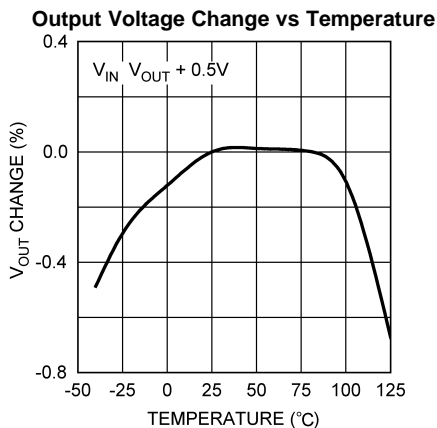

Figure 5.

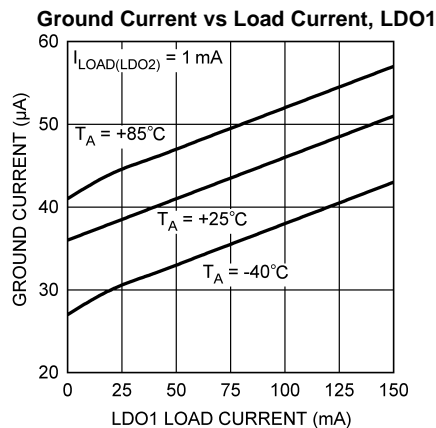

Figure 6.

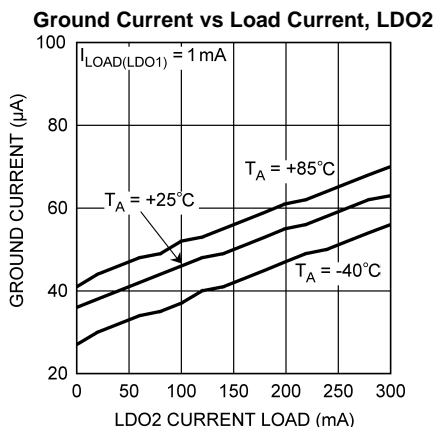

Figure 7.

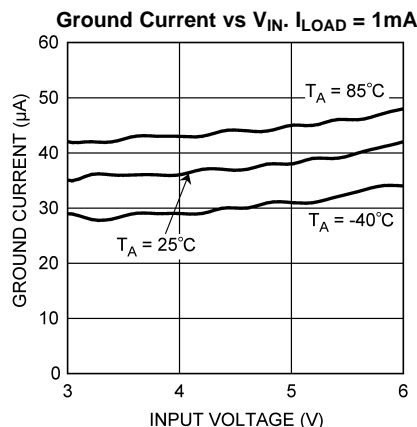

Figure 8.

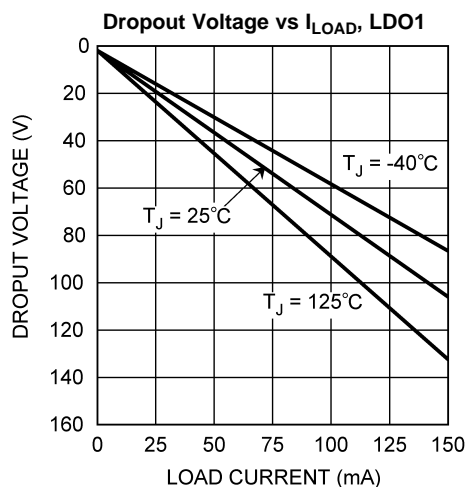

Figure 9.

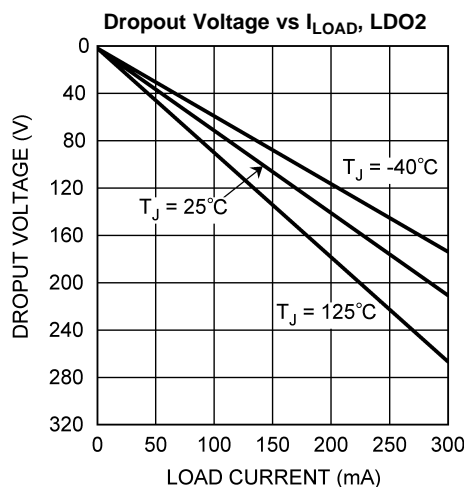

Figure 10.

TYPICAL PERFORMANCE CHARACTERISTICS (continued)

Unless otherwise specified, $C_{IN} = 1.0 \mu\text{F}$ Ceramic, $C_{OUT1} = C_{OUT2} = 1.0 \mu\text{F}$ Ceramic, $C_{BYP} = 10 \text{ nF}$, $V_{IN} = V_{OUT2(NOM)} + 1.0\text{V}$, $T_A = 25^\circ\text{C}$, $V_{OUT1(NOM)} = 3.3\text{V}$, $V_{OUT2(NOM)} = 3.3\text{V}$, Enable pins are tied to V_{IN} .

Short Circuit Current, LDO1

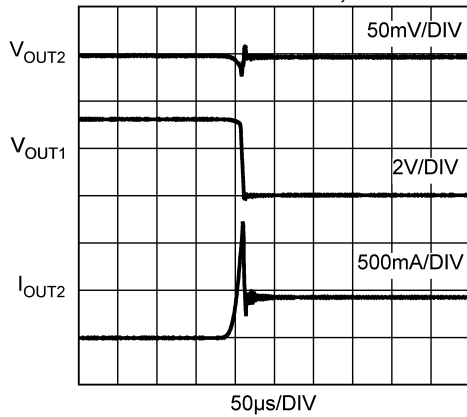

Figure 11.

Short Circuit Current, LDO2

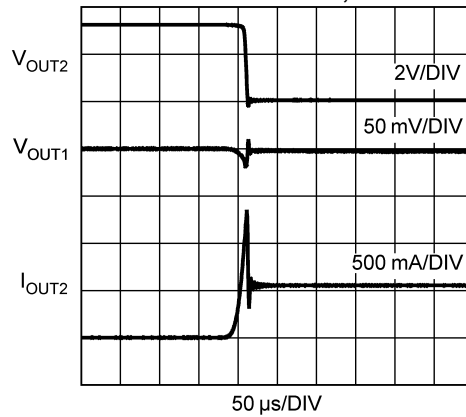

Figure 12.

Power Supply Rejection Ratio, LDO1

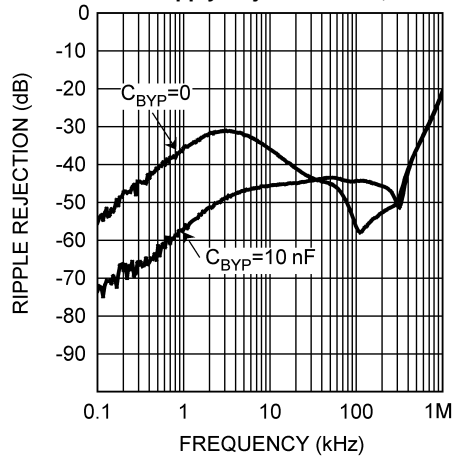

Figure 13.

Power Supply Rejection Ratio, LDO2

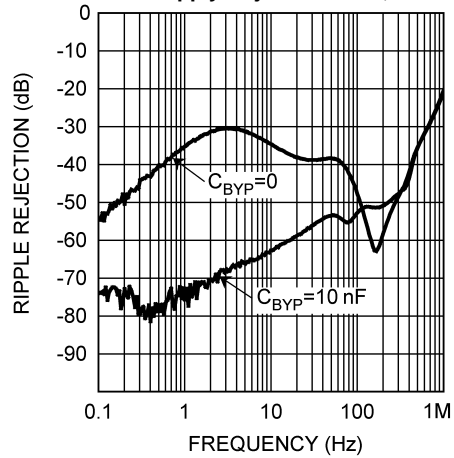

Figure 14.

Enable Start-up Time, $C_{BYP}=0$

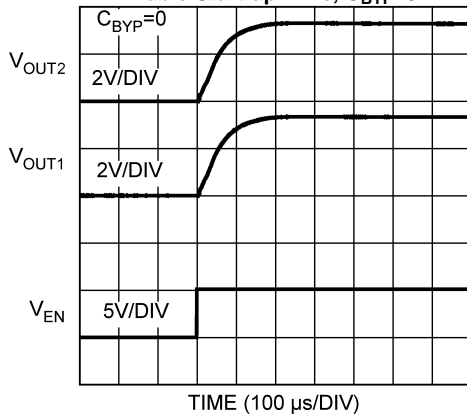

Figure 15.

Enable Start-up Time, $C_{BYP}=10\text{nF}$

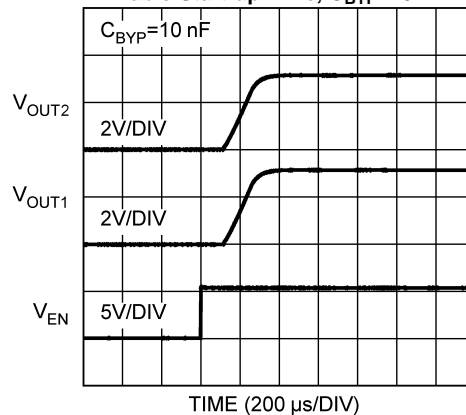

Figure 16.

TYPICAL PERFORMANCE CHARACTERISTICS (continued)

Unless otherwise specified, $C_{IN} = 1.0 \mu\text{F}$ Ceramic, $C_{OUT1} = C_{OUT2} = 1.0 \mu\text{F}$ Ceramic, $C_{BYP} = 10 \text{ nF}$, $V_{IN} = V_{OUT2(NOM)} + 1.0\text{V}$, $T_A = 25^\circ\text{C}$, $V_{OUT1(NOM)} = 3.3\text{V}$, $V_{OUT2(NOM)} = 3.3\text{V}$, Enable pins are tied to V_{IN} .

Line Transient, $C_{BYP}=10\text{nF}$

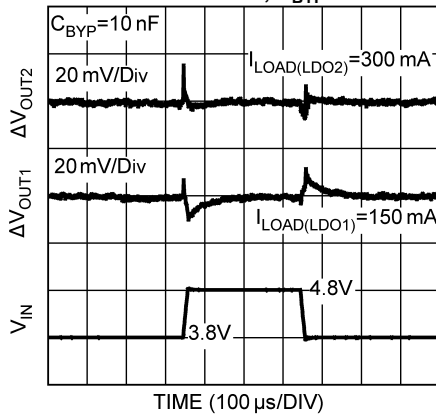

Figure 17.

Line Transient, $C_{BYP}=0$

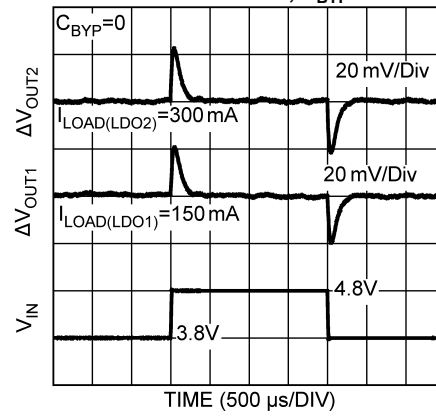

Figure 18.

Load Transient, LDO1

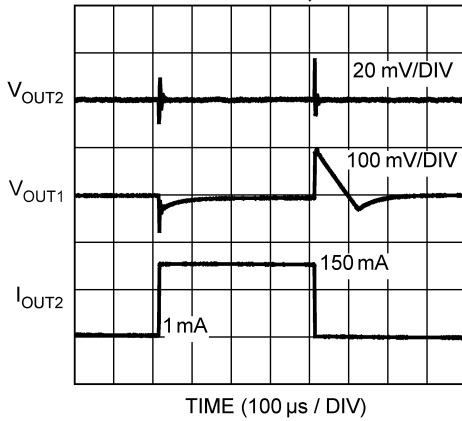

Figure 19.

Load Transient, LDO2

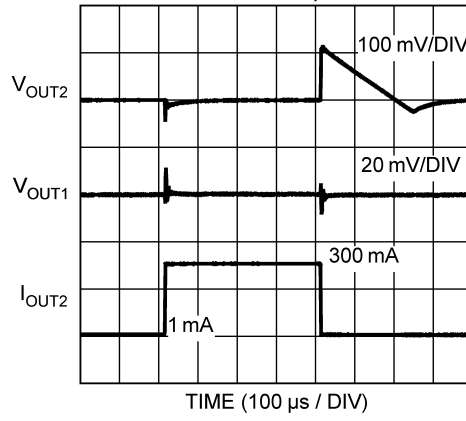

Figure 20.

Noise Density LDO1

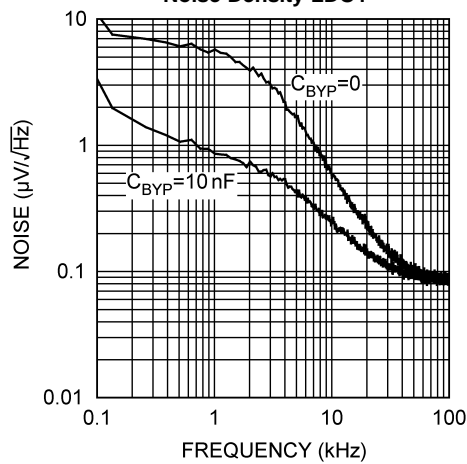

Figure 21.

Noise Density, LDO2

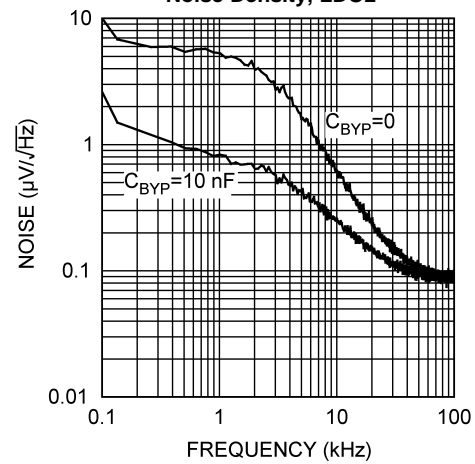

Figure 22.

TYPICAL PERFORMANCE CHARACTERISTICS (continued)

Unless otherwise specified, $C_{IN} = 1.0 \mu\text{F}$ Ceramic, $C_{OUT1} = C_{OUT2} = 1.0 \mu\text{F}$ Ceramic, $C_{BYP} = 10 \text{ nF}$, $V_{IN} = V_{OUT2(NOM)} + 1.0\text{V}$, $T_A = 25^\circ\text{C}$, $V_{OUT1(NOM)} = 3.3\text{V}$, $V_{OUT2(NOM)} = 3.3\text{V}$, Enable pins are tied to V_{IN} .

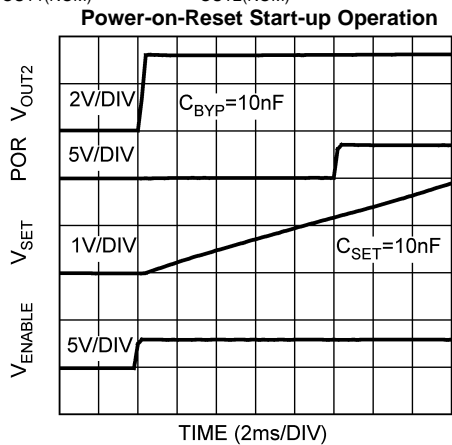

Figure 23.

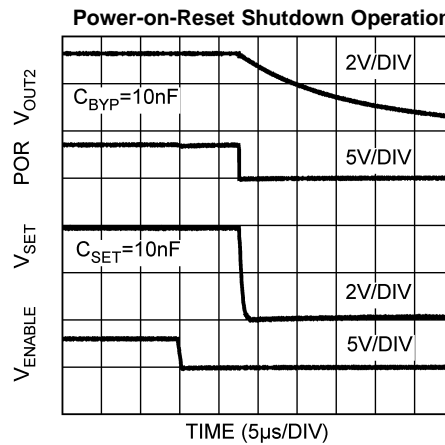

Figure 24.

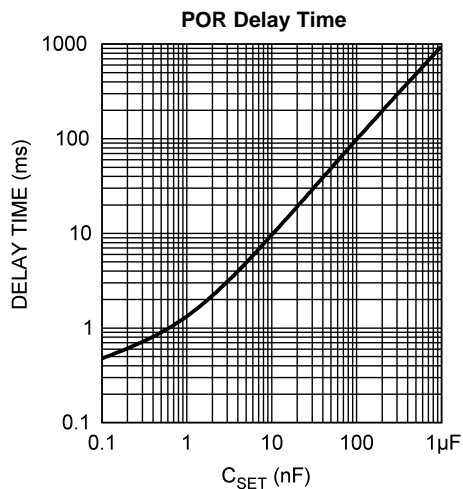

Figure 25.

APPLICATION HINTS

Operation Description

The LP3996 is a low quiescent current, power management IC, designed specifically for portable applications requiring minimum board space and smallest components. The LP3996 contains two independently selectable LDOs. The first is capable of sourcing 150 mA at outputs between 0.8V and 3.3V. The second can source 300 mA at an output voltage of 0.8V to 3.3V. In addition, LDO2 contains power good flag circuit, which monitors the output voltage and indicates when it is within 8% of its nominal value. The flag will also act as a power-on-reset signal and, by adding an external capacitor; a delay may be programmed for the POR output.

Input Capacitor

An input capacitor is required for stability. It is recommended that a 1.0 μF capacitor be connected between the LP3996 input pin and ground (this capacitance value may be increased without limit).

This capacitor must be located a distance of not more than 1 cm from the input pin and returned to a clean analogue ground. Any good quality ceramic, tantalum, or film capacitor may be used at the input.

Important: Tantalum capacitors can suffer catastrophic failures due to surge current when connected to a low-impedance source of power (like a battery or a very large capacitor). If a tantalum capacitor is used at the input, it must be ensured by the manufacturer to have a surge current rating sufficient for the application.

There are no requirements for the ESR (Equivalent Series Resistance) on the input capacitor, but tolerance and temperature coefficient must be considered when selecting the capacitor to ensure the capacitance will remain approximately 1.0 μF over the entire operating temperature range.

Output Capacitor

The LP3996 is designed specifically to work with very small ceramic output capacitors. A 1.0 μF ceramic capacitor (temperature types Z5U, Y5V or X7R) with ESR between 5 m Ω to 500 m Ω , is suitable in the LP3996 application circuit.

For this device the output capacitor should be connected between the V_{OUT} pin and ground.

It is also possible to use tantalum or film capacitors at the device output, C_{OUT} (or V_{OUT}), but these are not as attractive for reasons of size and cost (see [Capacitor Characteristics](#)).

The output capacitor must meet the requirement for the minimum value of capacitance and also have an ESR value that is within the range 5 m Ω to 500 m Ω for stability.

No-Load Stability

The LP3996 will remain stable and in regulation with no external load. This is an important consideration in some circuits, for example CMOS RAM keep-alive applications.

Capacitor Characteristics

The LP3996 is designed to work with ceramic capacitors on the output to take advantage of the benefits they offer. For capacitance values in the range of 0.47 μF to 4.7 μF , ceramic capacitors are the smallest, least expensive and have the lowest ESR values, thus making them best for eliminating high frequency noise. The ESR of a typical 1.0 μF ceramic capacitor is in the range of 20 m Ω to 40 m Ω , which easily meets the ESR requirement for stability for the LP3996.

For both input and output capacitors, careful interpretation of the capacitor specification is required to ensure correct device operation. The capacitor value can change greatly, depending on the operating conditions and capacitor type.

In particular, the output capacitor selection should take account of all the capacitor parameters, to ensure that the specification is met within the application. The capacitance can vary with DC bias conditions as well as temperature and frequency of operation. Capacitor values will also show some decrease over time due to aging. The capacitor parameters are also dependant on the particular case size, with smaller sizes giving poorer performance figures in general. As an example, [Figure 26](#) shows a typical graph comparing different capacitor case sizes in a Capacitance vs. DC Bias plot. As shown in the graph, increasing the DC Bias condition can result in the capacitance value falling below the minimum value given in the recommended capacitor specifications table (0.7 μF in this case). Note that the graph shows the capacitance out of spec for the 0402 case size capacitor at higher bias voltages. It is therefore recommended that the capacitor manufacturers' specifications for the nominal value capacitor are consulted for all conditions, as some capacitor sizes (that is, 0402) may not be suitable in the actual application.

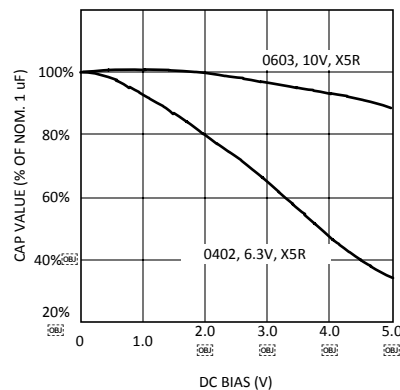

Figure 26. Graph Showing a Typical Variation in Capacitance vs DC Bias

The ceramic capacitor's capacitance can vary with temperature. The capacitor type X7R, which operates over a temperature range of -55°C to $+125^{\circ}\text{C}$, will only vary the capacitance to within $\pm 15\%$. The capacitor type X5R has a similar tolerance over a reduced temperature range of -55°C to $+85^{\circ}\text{C}$. Many large value ceramic capacitors, larger than 1 μF are manufactured with Z5U or Y5V temperature characteristics. Their capacitance can drop by more than 50% as the temperature varies from 25°C to 85°C . Therefore X7R is recommended over Z5U and Y5V in applications where the ambient temperature will change significantly above or below 25°C .

Tantalum capacitors are less desirable than ceramic for use as output capacitors because they are more expensive when comparing equivalent capacitance and voltage ratings in the 0.47 μF to 4.7 μF range.

Another important consideration is that tantalum capacitors have higher ESR values than equivalent size ceramics. This means that while it may be possible to find a tantalum capacitor with an ESR value within the stable range, it would have to be larger in capacitance (which means bigger and more costly) than a ceramic capacitor with the same ESR value. It should also be noted that the ESR of a typical tantalum will increase about 2:1 as the temperature goes from 25°C down to -40°C , so some guard band must be allowed.

Enable Control

The LP3996 features active high enable pins for each regulator, EN1 and EN2, which turns the corresponding LDO off when pulled low. The device outputs are enabled when the enable lines are set to high. When not enabled the regulator output is off and the device typically consumes 2nA.

If the application does not require the Enable switching feature, one or both enable pins should be tied to V_{IN} to keep the regulator output permanently on.

To ensure proper operation, the signal source used to drive the enable inputs must be able to swing above and below the specified turn-on / off voltage thresholds listed in the Electrical Characteristics section under V_{IL} and V_{IH} .

Power-On-Reset

The POR pin is an open-drain output which will be set to Low whenever the output of LDO2 falls out of regulation to approximately 90% of its nominal value. An external pull-up resistor, connected to V_{OUT} or V_{IN} , is required on this pin. During start-up, or whenever a fault condition is removed, the POR flag will return to the High state after the output reaches approximately 96% of its nominal value. By connecting a capacitor from the SET pin to GND, a delay to the rising condition of the POR flag may be introduced. The delayed signal may then be used as a Power-on -Reset for a microprocessor within the user's application.

The duration of the delay is determined by the time to charge the delay capacitor to a threshold voltage of 1.25V at 1.2 μ A from the SET pin as in the formula below.

$$t_{\text{DELAY}} = \frac{V_{\text{TH(SET)}} \times C_{\text{SET}}}{I_{\text{SET}}} \quad (1)$$

A 0.1 μ F capacitor will introduce a delay of approximately 100 ms.

Bypass Capacitor

The internal voltage reference circuit of the LP3996 is connected to the C_{BYP} pin via a high value internal resistor. An external capacitor, connected to this pin, forms a low-pass filter which reduces the noise level on both outputs of the device. There is also some improvement in PSSR and line transient performance. Internal circuitry ensures rapid charging of the C_{BYP} capacitor during start-up. A 10 nF, high quality ceramic capacitor with either NPO or COG dielectric is recommended due to their low leakage characteristics and low noise performance.

Safe Area of Operation

Due consideration should be given to operating conditions to avoid excessive thermal dissipation of the LP3996 or triggering its thermal shutdown circuit. When both outputs are enabled, the total power dissipation will be $P_{\text{D(LDO1)}} + P_{\text{D(LDO2)}}$ Where $P_{\text{D}} = (V_{\text{IN}} - V_{\text{OUT}}) \times I_{\text{OUT}}$ for each LDO.

In general, device options which have a large difference in output voltage will dissipate more power when both outputs are enabled, due to the input voltage required for the higher output voltage LDO. In such cases, especially at elevated ambient temperature, it may not be possible to operate both outputs at maximum current at the same time.

REVISION HISTORY**Changes from Revision B (March 2013) to Revision C** **Page**

- Changed layout of National Data Sheet to TI format; [14](#)
-

Changes from Revision C (March 2013) to Revision D **Page**

- Added Additional Device Table back to datasheet [3](#)
-

PACKAGING INFORMATION

Orderable Device	Status (1)	Package Type	Package Drawing	Pins	Package Qty	Eco Plan (2)	Lead/Ball Finish (6)	MSL Peak Temp (3)	Op Temp (°C)	Device Marking (4/5)	Samples
LP3996SD-0833/NOPB	ACTIVE	WSO	DSC	10	1000	Green (RoHS & no Sb/Br)	SN	Level-1-260C-UNLIM	-40 to 85	L167B	Samples
LP3996SD-1525/NOPB	ACTIVE	WSO	DSC	10	1000	Green (RoHS & no Sb/Br)	SN	Level-1-260C-UNLIM	-40 to 85	L168B	Samples
LP3996SD-1833/NOPB	ACTIVE	WSO	DSC	10	1000	Green (RoHS & no Sb/Br)	SN	Level-1-260C-UNLIM		L228B	Samples
LP3996SD-2533/NOPB	ACTIVE	WSO	DSC	10	1000	Green (RoHS & no Sb/Br)	SN	Level-1-260C-UNLIM		L229B	Samples
LP3996SD-3030/NOPB	ACTIVE	WSO	DSC	10	1000	Green (RoHS & no Sb/Br)	SN	Level-1-260C-UNLIM	-40 to 85	L172B	Samples
LP3996SD-3033/NOPB	ACTIVE	WSO	DSC	10	1000	Green (RoHS & no Sb/Br)	SN	Level-1-260C-UNLIM	-40 to 85	L170B	Samples
LP3996SD-3333/NOPB	ACTIVE	WSO	DSC	10	1000	Green (RoHS & no Sb/Br)	SN	Level-1-260C-UNLIM	-40 to 85	L173B	Samples

(1) The marketing status values are defined as follows:

ACTIVE: Product device recommended for new designs.

LIFEBUY: TI has announced that the device will be discontinued, and a lifetime-buy period is in effect.

NRND: Not recommended for new designs. Device is in production to support existing customers, but TI does not recommend using this part in a new design.

PREVIEW: Device has been announced but is not in production. Samples may or may not be available.

OBSELETE: TI has discontinued the production of the device.

(2) **RoHS:** TI defines "RoHS" to mean semiconductor products that are compliant with the current EU RoHS requirements for all 10 RoHS substances, including the requirement that RoHS substance do not exceed 0.1% by weight in homogeneous materials. Where designed to be soldered at high temperatures, "RoHS" products are suitable for use in specified lead-free processes. TI may reference these types of products as "Pb-Free".

RoHS Exempt: TI defines "RoHS Exempt" to mean products that contain lead but are compliant with EU RoHS pursuant to a specific EU RoHS exemption.

Green: TI defines "Green" to mean the content of Chlorine (Cl) and Bromine (Br) based flame retardants meet JS709B low halogen requirements of <=100ppm threshold. Antimony trioxide based flame retardants must also meet the <=1000ppm threshold requirement.

(3) MSL, Peak Temp. - The Moisture Sensitivity Level rating according to the JEDEC industry standard classifications, and peak solder temperature.

(4) There may be additional marking, which relates to the logo, the lot trace code information, or the environmental category on the device.

(5) Multiple Device Markings will be inside parentheses. Only one Device Marking contained in parentheses and separated by a "-" will appear on a device. If a line is indented then it is a continuation of the previous line and the two combined represent the entire Device Marking for that device.

⁽⁶⁾ Lead/Ball Finish - Orderable Devices may have multiple material finish options. Finish options are separated by a vertical ruled line. Lead/Ball Finish values may wrap to two lines if the finish value exceeds the maximum column width.

Important Information and Disclaimer:The information provided on this page represents TI's knowledge and belief as of the date that it is provided. TI bases its knowledge and belief on information provided by third parties, and makes no representation or warranty as to the accuracy of such information. Efforts are underway to better integrate information from third parties. TI has taken and continues to take reasonable steps to provide representative and accurate information but may not have conducted destructive testing or chemical analysis on incoming materials and chemicals. TI and TI suppliers consider certain information to be proprietary, and thus CAS numbers and other limited information may not be available for release.

In no event shall TI's liability arising out of such information exceed the total purchase price of the TI part(s) at issue in this document sold by TI to Customer on an annual basis.

OTHER QUALIFIED VERSIONS OF LP3996 :

- Automotive: [LP3996-Q1](#)

NOTE: Qualified Version Definitions:

- Automotive - Q100 devices qualified for high-reliability automotive applications targeting zero defects

TAPE AND REEL INFORMATION

QUADRANT ASSIGNMENTS FOR PIN 1 ORIENTATION IN TAPE

*All dimensions are nominal

Device	Package Type	Package Drawing	Pins	SPQ	Reel Diameter (mm)	Reel Width W1 (mm)	A0 (mm)	B0 (mm)	K0 (mm)	P1 (mm)	W (mm)	Pin1 Quadrant
LP3996SD-0833/NOPB	WSON	DSC	10	1000	178.0	12.4	3.3	3.3	1.0	8.0	12.0	Q1
LP3996SD-1525/NOPB	WSON	DSC	10	1000	178.0	12.4	3.3	3.3	1.0	8.0	12.0	Q1
LP3996SD-1833/NOPB	WSON	DSC	10	1000	178.0	12.4	3.3	3.3	1.0	8.0	12.0	Q1
LP3996SD-2533/NOPB	WSON	DSC	10	1000	178.0	12.4	3.3	3.3	1.0	8.0	12.0	Q1
LP3996SD-3030/NOPB	WSON	DSC	10	1000	178.0	12.4	3.3	3.3	1.0	8.0	12.0	Q1
LP3996SD-3033/NOPB	WSON	DSC	10	1000	178.0	12.4	3.3	3.3	1.0	8.0	12.0	Q1
LP3996SD-3333/NOPB	WSON	DSC	10	1000	178.0	12.4	3.3	3.3	1.0	8.0	12.0	Q1

TAPE AND REEL BOX DIMENSIONS

*All dimensions are nominal

Device	Package Type	Package Drawing	Pins	SPQ	Length (mm)	Width (mm)	Height (mm)
LP3996SD-0833/NOPB	WSON	DSC	10	1000	210.0	185.0	35.0
LP3996SD-1525/NOPB	WSON	DSC	10	1000	210.0	185.0	35.0
LP3996SD-1833/NOPB	WSON	DSC	10	1000	210.0	185.0	35.0
LP3996SD-2533/NOPB	WSON	DSC	10	1000	210.0	185.0	35.0
LP3996SD-3030/NOPB	WSON	DSC	10	1000	210.0	185.0	35.0
LP3996SD-3033/NOPB	WSON	DSC	10	1000	210.0	185.0	35.0
LP3996SD-3333/NOPB	WSON	DSC	10	1000	210.0	185.0	35.0

IMPORTANT NOTICE AND DISCLAIMER

TI PROVIDES TECHNICAL AND RELIABILITY DATA (INCLUDING DATASHEETS), DESIGN RESOURCES (INCLUDING REFERENCE DESIGNS), APPLICATION OR OTHER DESIGN ADVICE, WEB TOOLS, SAFETY INFORMATION, AND OTHER RESOURCES "AS IS" AND WITH ALL FAULTS, AND DISCLAIMS ALL WARRANTIES, EXPRESS AND IMPLIED, INCLUDING WITHOUT LIMITATION ANY IMPLIED WARRANTIES OF MERCHANTABILITY, FITNESS FOR A PARTICULAR PURPOSE OR NON-INFRINGEMENT OF THIRD PARTY INTELLECTUAL PROPERTY RIGHTS.

These resources are intended for skilled developers designing with TI products. You are solely responsible for (1) selecting the appropriate TI products for your application, (2) designing, validating and testing your application, and (3) ensuring your application meets applicable standards, and any other safety, security, or other requirements. These resources are subject to change without notice. TI grants you permission to use these resources only for development of an application that uses the TI products described in the resource. Other reproduction and display of these resources is prohibited. No license is granted to any other TI intellectual property right or to any third party intellectual property right. TI disclaims responsibility for, and you will fully indemnify TI and its representatives against, any claims, damages, costs, losses, and liabilities arising out of your use of these resources.

TI's products are provided subject to TI's Terms of Sale (www.ti.com/legal/termsofsale.html) or other applicable terms available either on ti.com or provided in conjunction with such TI products. TI's provision of these resources does not expand or otherwise alter TI's applicable warranties or warranty disclaimers for TI products.

Mailing Address: Texas Instruments, Post Office Box 655303, Dallas, Texas 75265
Copyright © 2020, Texas Instruments Incorporated