

NB3RL02

Low Phase-Noise Two-Channel Clock Fanout Buffer

The NB3RL02 is a low-skew, low jitter 1:2 clock fan-out buffer, ideal for use in portable end-equipment, such as mobile phones. With integrated LDO and output control circuitry.

The MCLK_IN pin has an AC coupling capacitor and will directly accept a square or sine wave clock input, such as a temperature compensated crystal oscillator (TCXO). The minimum acceptable input amplitude of the sine wave is 300 mV peak-to-peak.

The two clock outputs are enabled by control inputs CLK_REQ1 and CLK_REQ2.

The NB3RL02 has an integrated Low-Drop-Out (LDO) voltage regulator which accepts input voltages from 2.3 V to 5.5 V and outputs 1.8 V at $I_{out} = 50$ mA. This 1.8 V supply is externally available to provide regulated power to peripheral devices, such as a TCXO.

The adaptive clock output buffers offer controlled slew-rate over a wide capacitive loading range which minimizes EMI emissions, maintains signal integrity, and minimizes ringing caused by signal reflections on the clock distribution lines.

The NB3RL02 is offered in a 0.4 mm pitch wafer-level-chip-scale (WLCS) package and is optimized for very low standby current consumption.

Features

- Low Additive Noise:
 - ◆ -149 dBc/Hz at 10 kHz Offset Phase Noise
 - ◆ 0.37 ps (rms) Output Jitter
- Limited Output Slew Rate for EMI Reduction (1 ns to 5 ns/Rise/Fall Time for 10–50 pF Loads)
- Regulated 1.8 V Output Supply Available for External Clock Source, ie. TCXO
- Ultra-Small Package:
 - ◆ 8-ball: 0.4 mm Pitch WLCS
- ESD Performance Exceeds JESD 22
 - ◆ 2000 V Human-Body Model (A114-A)
 - ◆ 200 V Machine Model (A115-A)
 - ◆ 1000 V Charged-Device Model (JESD22-C101-A Level III)
- These are Pb-Free Devices

Applications

- Cellular Phones
- Global Positioning Systems (GPS)



ON Semiconductor®

www.onsemi.com

MARKING DIAGRAMS



WLCSP8
CASE 499BQ

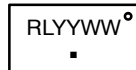

RL = Specific Device Code
YY = Year
WW = Work Week
■ = Pb-Free Package

LOGIC DIAGRAM

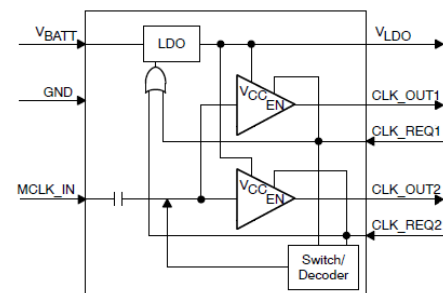

ORDERING INFORMATION

See detailed ordering and shipping information in the package dimensions section on page 6 of this data sheet.

NB3RL02

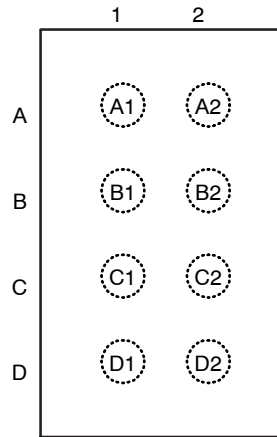

(Package – Flip Chip)
Die Pads Face Down on PCB

Figure 1. Pinout (Top View)

Table 1. PIN DESCRIPTION

Ball No.	Name	I/O	Description
A1	VBATT	I	Input to internal LDO
A2	CLK_OUT1	O	Clock output 1
B1	VLDO	O	1.8 V supply for NB3RL02 and external TCXO
B2	CLK_REQ1	I	Clock request from peripheral 1
C1	MCLK_IN	I	Master clock input
C2	CLK_REQ2	I	Clock request from peripheral 2
D1	GND	-	Ground
D2	CLK_OUT2	O	Clock output 2

Table 2. FUNCTION TABLE

Inputs			Outputs		
CLK_REQ1	CLK_REQ2	MCLK_IN	CLK_OUT1	CLK_OUT2	VLDO
L	L	X	L	L	0 V
L	H	CLK	L	CLK	1.8 V
H	L	CLK	CLK	L	1.8 V
H	H	CLK	CLK	CLK	1.8 V

NB3RL02

Table 3. ABSOLUTE MAXIMUM RATINGS

Symbol	Parameter	Condition	Min	Max	Unit
V _{BATT}	V _{BATT} Voltage Range (Note 1)		-0.3	7	V
	Voltage range (Note 2)	CLK_REQ_1/2, MCLK_IN	-0.3	V _{BATT} + 0.3	V
		V _{LDO} , CLK_OUT_1/2 (Note 1)	-0.3	V _{BATT} + 0.3	
I _{IK}	Input clamp current at V _{BATT} , CLK_REQ_1/2, and MCLK_IN	V _I < 0		-50	mA
I _O	Continuous output current	CLK_OUT1/2		± 20	mA
	Continuous current through GND, V _{BATT} , V _{LDO}	Continuous current through GND, V _{BATT} , V _{LDO}		± 50	mA
	ESD Rating	Human-Body Model		2000	V
		Charged-Device Model		1000	
		Machine Model		200	
T _J	Operating virtual junction temperature		-40	150	°C
T _A	Operating ambient temperature range		-40	85	°C
T _{stg}	Storage temperature range		-55	150	°C

Stresses exceeding those listed in the Maximum Ratings table may damage the device. If any of these limits are exceeded, device functionality should not be assumed, damage may occur and reliability may be affected.

1. The input negative-voltage and output voltage ratings may be exceeded if the input and output current ratings are observed.
2. All voltage values are with respect to network ground terminal.

Table 4. RECOMMENDED OPERATING CONDITIONS (Note 3)

Symbol	Parameter		Min	Max	Unit
V _{BATT}	Input voltage	V _{BATT}	2.3	5.5	V
V _I	Input voltage Amplitude	MCLK_IN, CLK_REQ1/2	0	1.89	V
V _O	Output voltage	CLK_OUT1/2	0	1.8	V
V _{IH}	High-level input voltage	CLK_REQ1/2	1.3	1.89	V
V _{IL}	Low-level input voltage	CLK_REQ1/2	0	0.5	V
I _{OH}	High-level output current, DC current		-8		mA
I _{OL}	Low-level output current, DC current			8	mA

3. All unused inputs of the device must be held at V_{CC} or GND to ensure proper device operation.

NB3RL02

Table 5. ELECTRICAL CHARACTERISTICS ($T_A = -40^{\circ}\text{C}$ to $+85^{\circ}\text{C}$)

Symbol	Parameter	Test Conditions	Min	Typ	Max	Unit	
LDO							
V_{OUT}	LDO output voltage	$I_{OUT} = 50\text{ mA}$	1.71	1.8	1.89	V	
C_{LDO}	External load capacitance		1		10	μF	
$I_{OUT(SC)}$	Short circuit output current	$R_L = 0\ \Omega$		100		mA	
$I_{OUT(PK)}$	Peak output current	$V_{BATT} = 2.3\text{ V}$, $V_{LDO} = V_{OUT} - 5\%$		55	100	mA	
PSR	Power supply rejection	$V_{BATT} = 2.3\text{ V}$, $I_{OUT} = 2\text{ mA}$	$f_{IN} = 217\text{ Hz}$ and 1 kHz	60			dB
			$f_{IN} = 3.25\text{ MHz}$	40			
t_{su}	LDO start-up time	$V_{BATT} = 2.3\text{ V}$, $C_{LDO} = 1\ \mu\text{F}$, CLK_REQ_n to $V_{LDO} = 1.71\text{ V}$		0.2		ms	
		$V_{BATT} = 5.5\text{ V}$, $C_{LDO} = 10\ \mu\text{F}$, CLK_REQ_n to $V_{LDO} = 1.71\text{ V}$			1	ms	
POWER CONSUMPTION							
I_{SB}	Standby current	Device in standby (all VCLK_REQ_n = 0 V)		0.2	1	μA	
I_{CCS}	Static current consumption	Device active but not switching, $V_{CLK_REQn} = \text{H}$		0.4	1	mA	
I_{OB}	Output buffer average current	$f_{IN} = 26\text{ MHz}$, $C_{LOAD} = 50\text{ pF}$		4.2		mA	
C_{PD}	Output power dissipation capacitance	$f_{IN} = 26\text{ MHz}$			44	pF	
MCLK_IN INPUT							
I_l	MCLK_IN, CLK_REQ_1/2 leakage current	$V_l = V_{LDO}$ or GND			1	μA	
C_l	MCLK_IN capacitance	$f_{IN} = 26\text{ MHz}$		3.75		pF	
R_l	MCLK_IN impedance	$f_{IN} = 26\text{ MHz}$		5		k Ω	
f_{IN}	MCLK_IN frequency range		9	26	52	MHz	
MCLK_IN LVCMOS SOURCE							
	Phase noise	$f_{IN} = 26\text{ MHz}$, $tr/tf \leq 1\text{ ns}$	1 kHz offset		-140		dBc/Hz
			10 kHz offset		-149		
			100 kHz offset		-153		
			1 MHz offset		-151		
	Additive jitter	$f_{IN} = 26\text{ MHz}$, $V_{PP} = 0.8\text{ V}$, BW = 10 kHz – 5 MHz		0.37		ps (rms)	
t_{DL}	MCLK_IN to CLK_OUT_n propagation delay			10		ns	
DC_L	Output duty cycle	$f_{IN} = 26\text{ MHz}$, $DC_{IN} = 50\%$	45	50	55	%	

NOTE: Device will meet the specifications after thermal equilibrium has been established when mounted in a test socket or printed circuit board with maintained transverse airflow greater than 500 lfm.

NB3RL02

Table 5. ELECTRICAL CHARACTERISTICS ($T_A = -40^{\circ}\text{C}$ to $+85^{\circ}\text{C}$)

Symbol	Parameter	Test Conditions	Min	Typ	Max	Unit	
MCLK_IN SINUSOIDAL SOURCE							
V_{MA}	Input amplitude		0.3		1.8	V	
	Phase noise	$f_{IN} = 26\text{ MHz}$, $V_{MA} = 1.8\text{ V}_{PP}$	1 kHz offset		-138		dBc/Hz
			10 kHz offset		-146		
			100 kHz offset		-151		
			1 MHz offset		-149		
		$f_{IN} = 26\text{ MHz}$, $V_{MA} = 0.8\text{ V}_{PP}$	1 kHz offset		-138		
			10 kHz offset		-146		
			100 kHz offset		-150		
			1 MHz offset		-148		
	Additive jitter	$f_{IN} = 26\text{ MHz}$, $V_{MA} = 1.8\text{ V}_{PP}$, BW = 10 kHz – 5 MHz		0.37		ps (rms)	
t_{DS}	MCLK_IN to CLK_OUT_1/2 propagation delay			12		ns	
DC	Output duty cycle	$f_{IN} = 26\text{ MHz}$, $V_{MA} > 1.8\text{ V}_{PP}$	45	50	55	%	
CLK_OUT_N OUTPUTS							
t_r	20% to 80% rise time	$C_L = 10\text{ pF}$ to 50 pF	1		5	ns	
t_f	20% to 80% fall time	$C_L = 10\text{ pF}$ to 50 pF	1		5	ns	
t_{sk}	Channel-to-channel skew	$C_L = 10\text{ pF}$ to 50 pF , ($C_{L1} = C_{L2}$)	-0.5		0.5	ns	
V_{OH}	High-level output voltage	$I_{OH} = -100\text{ }\mu\text{A}$, reference to V_{LDO}	-0.1			V	
		$I_{OH} = -8\text{ mA}$	1.2				
V_{OL}	Low-level output voltage	$I_{OL} = 20\text{ }\mu\text{A}$			0.2	V	
		$I_{OL} = 8\text{ mA}$			0.55		

NOTE: Device will meet the specifications after thermal equilibrium has been established when mounted in a test socket or printed circuit board with maintained transverse airflow greater than 500 lfm.

NB3RL02

APPLICATION INFORMATION

Typical Application

A typical mobile application for the NB3RL02 is shown in Figure 2. An external low noise TCXO clock source is powered by the NB3RL02's 1.8 V regulated LDO and is

buffered to drive a mobile GPS receiver and WLAN transceiver. Each peripheral can independently request an active clock by asserting a clock request line (CLK_REQ1 or CLK_REQ2).

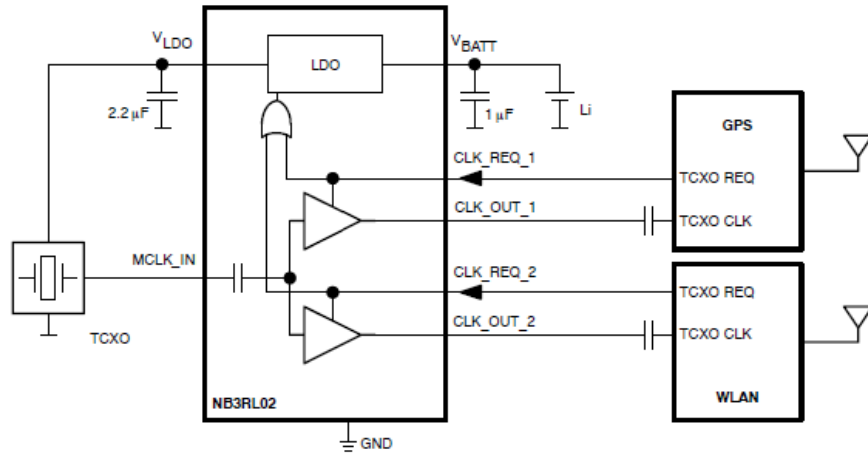

Figure 2. Mobile Application

When both clock request lines are logic LOW, the NB3RL02 enters a current-saving shutdown mode. In this mode, the LDO output goes to 0 V and turns off the TCXO. Also, the unpowered CLK_OUT1 and CLK_OUT2 outputs are pulled to GND.

When the NB3RL02 receives a HIGH from either peripheral CLK_REQn, the 1.8 V LDO output is enabled and will power the TCXO. The output of the TCXO can be a square wave, sine wave, or clipped sine wave and is converted to a buffered square wave.

Input Clock to Output Square Wave Generator

Figure 3 shows the MCLK_IN input having an internal AC coupling capacitor. This allows either a square or sine wave signal to be directly connected from a TCXO. Therefore, an external series capacitor is not required.

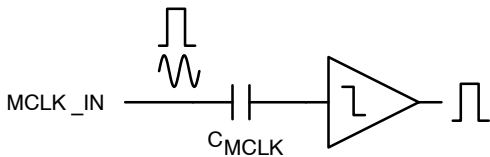

Figure 3. Input Stage

The clock frequency band of the NB3RL02 is 9 MHz to 52 MHz with all performance metrics specified at 26 MHz.

Typical input sinusoidal signal amplitude is 0.8 V_{pp} for specified performance, but amplitudes as low as 0.3 V_{pp} are

acceptable, but with reduced phase noise and jitter performance.

CLK_OUT1 and CLK_OUT2 Outputs

The CLK_OUT1 and CLK_OUT2 outputs drive 1.8 V LVCMOS levels with rise/fall times within 1 ns to 5 ns with load capacitors between 10 pF and 50 pF. These relatively slow edge rates will minimize EMI radiation into the system. When not requested, each output is set to Low to avoid false clocking of the load device.

LDO

The integrated low noise 1.8 V LDO provides power internal to the NB3RL02 as well as a power source for an external clock such as a TCXO. The input range of the LDO allows the device to be powered directly from a single cell Li battery. The LDO is enabled when either of the CLK_REQn signals is High.

When disabled, the device turns off the LDO and enters a low power shutdown mode consuming less than 1 µA from the battery.

The LDO requires an output decoupling capacitor in the range of 1 µF to 10 µF for compensation and high frequency PSR. An input bypass capacitor of 1 µF or larger is recommended.

ORDERING INFORMATION

Device	Temperature Range	Package	Shipping†
NB3RL02FCT2G	-40°C to 85°C	WLCSP8 (Pb-Free)	3000 / Tape & Reel

†For information on tape and reel specifications, including part orientation and tape sizes, please refer to our Tape and Reel Packaging Specifications Brochure, BRD8011/D.

MECHANICAL CASE OUTLINE PACKAGE DIMENSIONS

ON Semiconductor®



SCALE 4:1

WLCSP8, 1.57x0.77
CASE 499BQ
ISSUE A

DATE 01 SEP 2015

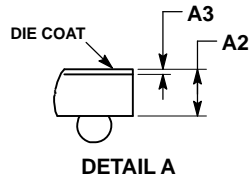
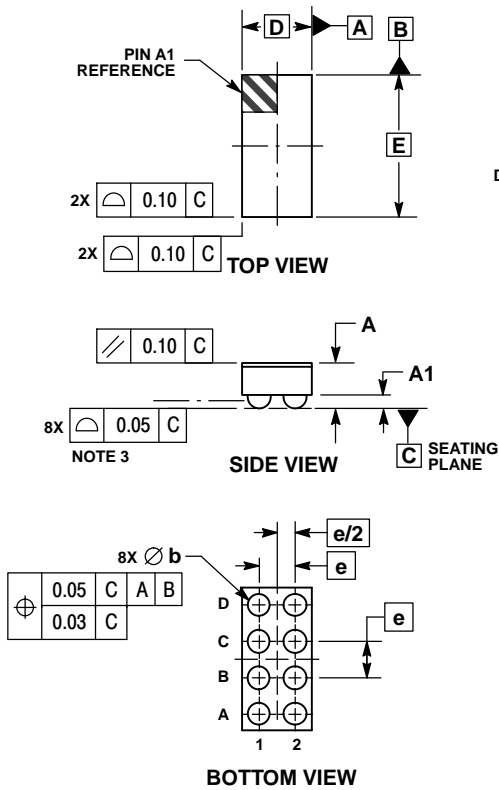

NOTES:

1. DIMENSIONING AND TOLERANCING PER ASME Y14.5M, 1994.
2. CONTROLLING DIMENSION: MILLIMETERS.
3. COPLANARITY APPLIES TO SPHERICAL CROWNS OF SOLDER BALLS.

DIM	MILLIMETERS	
	MIN	MAX
A	---	0.50
A1	0.13	0.17
A2	0.30 REF	
A3	0.025 BSC	
b	0.21	0.25
D	0.77 BSC	
E	1.57 BSC	
e	0.40 BSC	

GENERIC MARKING DIAGRAM*

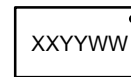

XX = Specific Device Code
 YY = Year
 WW = Work Week

*This information is generic. Please refer to device data sheet for actual part marking. Pb-Free indicator, "G" or microdot "▪", may or may not be present.

RECOMMENDED SOLDERING FOOTPRINT*

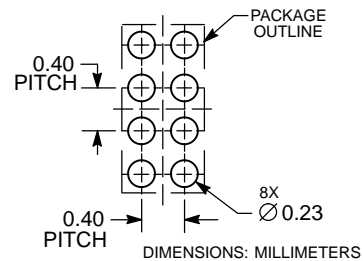

*For additional information on our Pb-Free strategy and soldering details, please download the ON Semiconductor Soldering and Mounting Techniques Reference Manual, SOLDERRM/D.

DOCUMENT NUMBER:	98AON56424E	Electronic versions are uncontrolled except when accessed directly from the Document Repository. Printed versions are uncontrolled except when stamped "CONTROLLED COPY" in red.
STATUS:	ON SEMICONDUCTOR STANDARD	
NEW STANDARD:		
DESCRIPTION:	WLCSP8, 1.57X0.77	PAGE 1 OF 2



ISSUE	REVISION	DATE
O	RELEASED FOR PRODUCTION. REQ. BY J. BASS.	13 APR 2011
A	ADDED DIE COAT INFORMATION, DETAIL A AND DIMENSIONS A2 & A3. REQ. BY J. BASS.	01 SEP 2015

ON Semiconductor and ON are registered trademarks of Semiconductor Components Industries, LLC (SCILLC). SCILLC reserves the right to make changes without further notice to any products herein. SCILLC makes no warranty, representation or guarantee regarding the suitability of its products for any particular purpose, nor does SCILLC assume any liability arising out of the application or use of any product or circuit, and specifically disclaims any and all liability, including without limitation special, consequential or incidental damages. "Typical" parameters which may be provided in SCILLC data sheets and/or specifications can and do vary in different applications and actual performance may vary over time. All operating parameters, including "Typicals" must be validated for each customer application by customer's technical experts. SCILLC does not convey any license under its patent rights nor the rights of others. SCILLC products are not designed, intended, or authorized for use as components in systems intended for surgical implant into the body, or other applications intended to support or sustain life, or for any other application in which the failure of the SCILLC product could create a situation where personal injury or death may occur. Should Buyer purchase or use SCILLC products for any such unintended or unauthorized application, Buyer shall indemnify and hold SCILLC and its officers, employees, subsidiaries, affiliates, and distributors harmless against all claims, costs, damages, and expenses, and reasonable attorney fees arising out of, directly or indirectly, any claim of personal injury or death associated with such unintended or unauthorized use, even if such claim alleges that SCILLC was negligent regarding the design or manufacture of the part. SCILLC is an Equal Opportunity/Affirmative Action Employer. This literature is subject to all applicable copyright laws and is not for resale in any manner.

ON Semiconductor and  are trademarks of Semiconductor Components Industries, LLC dba ON Semiconductor or its subsidiaries in the United States and/or other countries. ON Semiconductor owns the rights to a number of patents, trademarks, copyrights, trade secrets, and other intellectual property. A listing of ON Semiconductor's product/patent coverage may be accessed at www.onsemi.com/site/pdf/Patent-Marking.pdf. ON Semiconductor reserves the right to make changes without further notice to any products herein. ON Semiconductor makes no warranty, representation or guarantee regarding the suitability of its products for any particular purpose, nor does ON Semiconductor assume any liability arising out of the application or use of any product or circuit, and specifically disclaims any and all liability, including without limitation special, consequential or incidental damages. Buyer is responsible for its products and applications using ON Semiconductor products, including compliance with all laws, regulations and safety requirements or standards, regardless of any support or applications information provided by ON Semiconductor. "Typical" parameters which may be provided in ON Semiconductor data sheets and/or specifications can and do vary in different applications and actual performance may vary over time. All operating parameters, including "Typicals" must be validated for each customer application by customer's technical experts. ON Semiconductor does not convey any license under its patent rights nor the rights of others. ON Semiconductor products are not designed, intended, or authorized for use as a critical component in life support systems or any FDA Class 3 medical devices or medical devices with a same or similar classification in a foreign jurisdiction or any devices intended for implantation in the human body. Should Buyer purchase or use ON Semiconductor products for any such unintended or unauthorized application, Buyer shall indemnify and hold ON Semiconductor and its officers, employees, subsidiaries, affiliates, and distributors harmless against all claims, costs, damages, and expenses, and reasonable attorney fees arising out of, directly or indirectly, any claim of personal injury or death associated with such unintended or unauthorized use, even if such claim alleges that ON Semiconductor was negligent regarding the design or manufacture of the part. ON Semiconductor is an Equal Opportunity/Affirmative Action Employer. This literature is subject to all applicable copyright laws and is not for resale in any manner.

PUBLICATION ORDERING INFORMATION

LITERATURE FULFILLMENT:

Literature Distribution Center for ON Semiconductor
19521 E. 32nd Pkwy, Aurora, Colorado 80011 USA
Phone: 303-675-2175 or 800-344-3860 Toll Free USA/Canada
Fax: 303-675-2176 or 800-344-3867 Toll Free USA/Canada
Email: orderlit@onsemi.com

N. American Technical Support: 800-282-9855 Toll Free
USA/Canada
Europe, Middle East and Africa Technical Support:
Phone: 421 33 790 2910

ON Semiconductor Website: www.onsemi.com

Order Literature: <http://www.onsemi.com/orderlit>

For additional information, please contact your local Sales Representative

Mouser Electronics

Authorized Distributor

Click to View Pricing, Inventory, Delivery & Lifecycle Information:

[ON Semiconductor:](#)

[NB3RL02FCT2G](#)