

SMALL SIGNAL SCHOTTKY DIODES

DESCRIPTION

General purpose, metal to silicon diodes featuring very low turn-on voltage and fast switching.

These devices have integrated protection against excessive voltage such as electrostatic discharges.

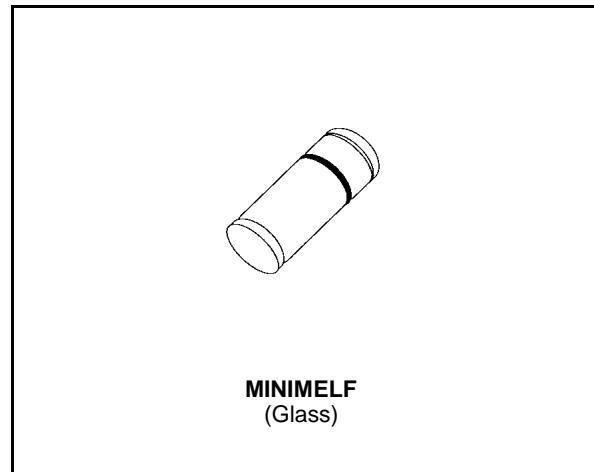

ABSOLUTE RATINGS (limiting values)

Symbol	Parameter	TMMBAT47	TMMBAT48	Unit
V_{RRM}	Repetitive Peak Reverse Voltage	20	40	V
I_F	Forward Continuous Current	$T_1 = 25\text{ °C}$ 350		mA
I_{FRM}	Repetitive Peak Forward Current	$t_p \leq 1\text{ s}$ $\delta \leq 0.5$ 1		A
I_{FSM}	Surge non Repetitive Forward Current	$t_p = 10\text{ ms}$ 7.5		A
		$t_p = 1\text{ s}$ 1.5		
P_{tot}	Power Dissipation	$T_1 = 25\text{ °C}$ 330		mW
T_{stg} T_j	Storage and Junction Temperature Range	- 65 to 150		°C
		- 65 to 125		°C
T_L	Maximum Temperature for Soldering during 15s	260		°C

THERMAL RESISTANCE

Symbol	Test Conditions	Value	Unit
$R_{th(j-l)}$	Junction-leads	300	°C/W

ELECTRICAL CHARACTERISTICS
STATIC CHARACTERISTICS

Symbol	Test Conditions			Min.	Typ.	Max.	Unit
V _{BR}	T _j = 25°C	I _R = 10μA	TMMBAT47	20			V
	T _j = 25°C	I _R = 25μA	TMMBAT48	40			
V _F *	T _j = 25°C	I _F = 0.1mA	All Types			0.25	V
	T _j = 25°C	I _F = 1mA				0.3	
	T _j = 25°C	I _F = 10mA				0.4	
	T _j = 25°C	I _F = 30mA	TMMBAT47			0.5	
	T _j = 25°C	I _F = 150mA				0.8	
	T _j = 25°C	I _F = 300mA				1	
	T _j = 25°C	I _F = 50mA	TMMBAT48			0.5	
	T _j = 25°C	I _F = 200mA				0.75	
	T _j = 25°C	I _F = 500mA				0.9	
I _R *	T _j = 25°C	V _R = 1.5V	All Types			1	μA
	T _j = 60°C					10	
	T _j = 25°C	V _R = 10V	TMMBAT47			4	
	T _j = 60°C					20	
	T _j = 25°C	V _R = 20V				10	
	T _j = 60°C					30	
	T _j = 25°C	V _R = 10V	TMMBAT48			2	
	T _j = 60°C					15	
	T _j = 25°C	V _R = 20V				5	
	T _j = 60°C					25	
	T _j = 25°C	V _R = 40V				25	
	T _j = 60°C					50	

DYNAMIC CHARACTERISTICS

Symbol	Test Conditions			Min.	Typ.	Max.	Unit	
C	T _j = 25°C	V _R = 0V	f = 1MHz		20		pF	
	T _j = 25°C	V _R = 1V			12			
t _{rr}	T _j = 25°C	I _F = 10mA	V _R = 1V	i _{rr} = 1mA	R _L = 100Ω		10	ns

* Pulse test: t_p ≤ 300μs δ < 2%.

Figure 1. Forward current versus forward voltage at different temperatures (typical values).

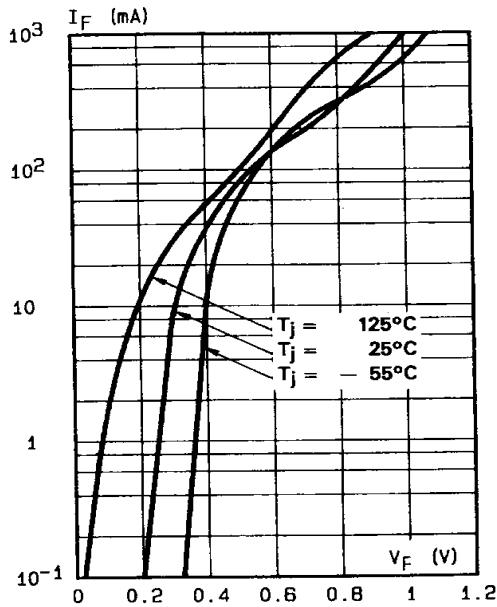

Figure 2. Forward current versus forward voltage (typical values).

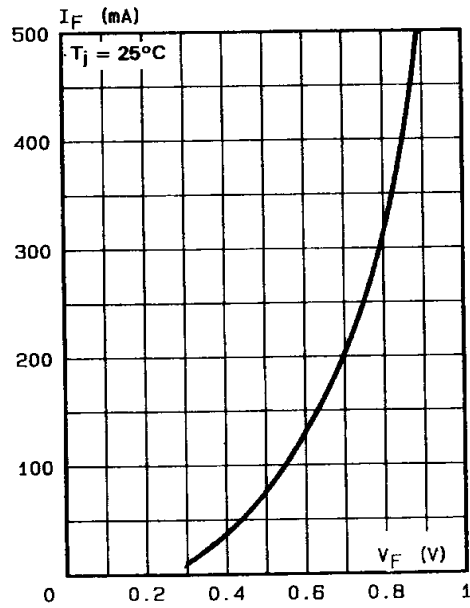

Figure 3. Reverse current versus junction temperature.

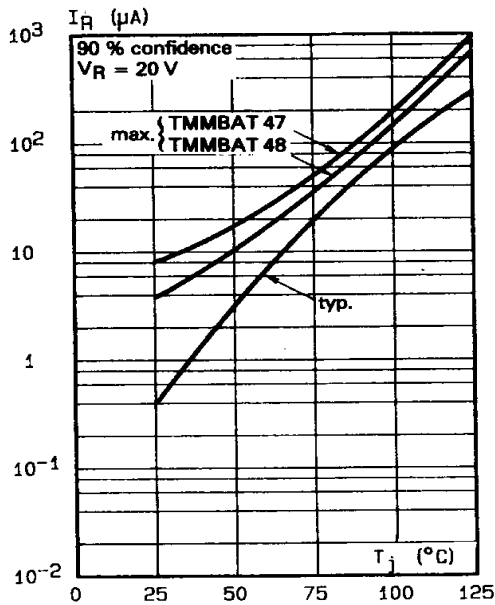

Figure 4. Reverse current versus continuous reverse voltage (typical values).

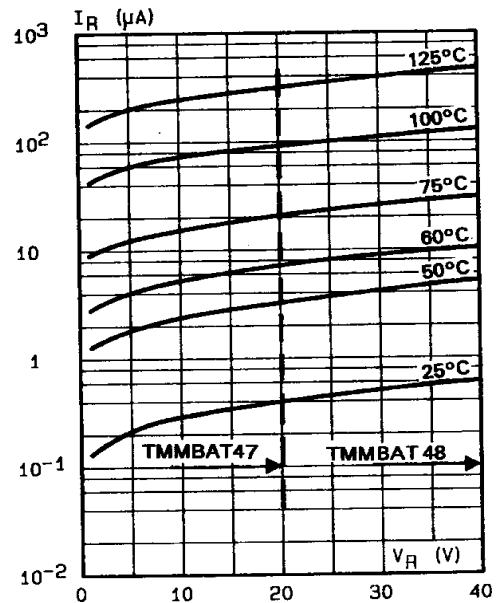
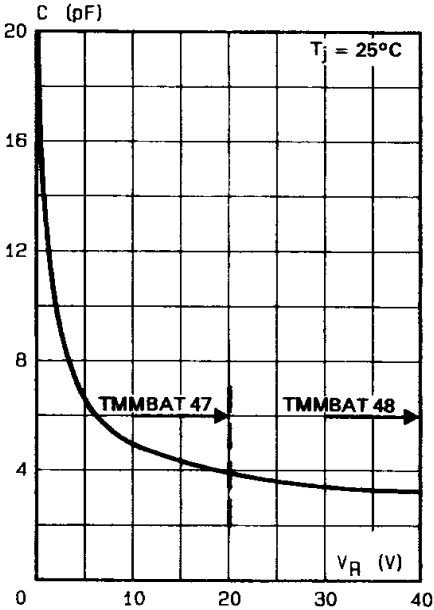
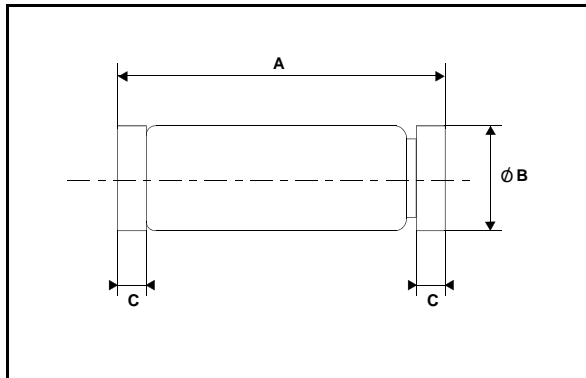

Figure 5. Capacitance C versus reverse applied voltage V_R (typical values).



PACKAGE MECHANICAL DATA

MINIMELF Glass



REF.	DIMENSIONS					
	Millimeters			Inches		
	Min.	Typ.	Max.	Min.	Typ.	Max.
A	3.30	3.40	3.6	0.130	0.134	0.142
B	1.59	1.60	1.62	0.063	0.063	0.064
C	0.40	0.45	0.50	0.016	0.018	0.020
D		1.50			0.059	

FOOT PRINT DIMENSIONS (Millimeter)

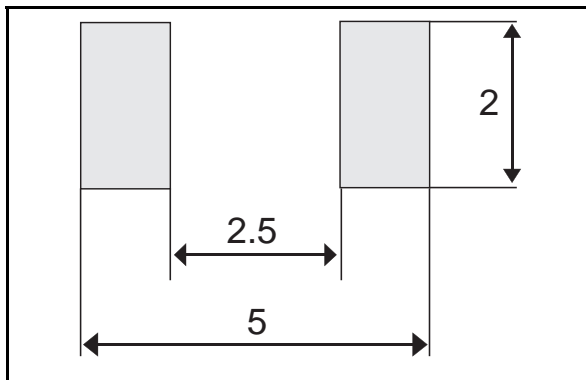

Marking: ring at cathode end.
Weight: 0.05g

Information furnished is believed to be accurate and reliable. However, STMicroelectronics assumes no responsibility for the consequences of use of such information nor for any infringement of patents or other rights of third parties which may result from its use. No license is granted by implication or otherwise under any patent or patent rights of STMicroelectronics. Specifications mentioned in this publication are subject to change without notice. This publication supersedes and replaces all information previously supplied. STMicroelectronics products are not authorized for use as critical components in life support devices or systems without express written approval of STMicroelectronics.

The ST logo is a registered trademark of STMicroelectronics
© 1999 STMicroelectronics - Printed in Italy - All rights reserved.

STMicroelectronics GROUP OF COMPANIES
Australia - Brazil - China - Finland - France - Germany - Hong Kong - India - Italy - Japan - Malaysia
Malta - Morocco - Singapore - Spain - Sweden - Switzerland - United Kingdom - U.S.A.

<http://www.st.com>

Mouser Electronics

Authorized Distributor

Click to View Pricing, Inventory, Delivery & Lifecycle Information:

[STMicroelectronics:](#)

[TMMBAT48FILM](#)