

## Film Capacitors

### Metallized Polypropylene Film Capacitors (MKP)

**Series/Type:** B32656S ... B32658S

**Date:** July 2015

© EPCOS AG 2015. Reproduction, publication and dissemination of this publication, enclosures hereto and the information contained therein without EPCOS' prior express consent is prohibited.

EPCOS AG is a TDK Group Company.

**Snubber (wound)****Typical applications**

- IGBT
- Snubbing

**Climatic**

- Max. operating temperature: 110 °C
- Climatic category (IEC 60068-1): 55/100/56

**Construction**

- Dielectric: polypropylene (PP)
- Wound capacitor technology with internal series connection
- Plastic case (UL 94 V-0)
- Epoxy resin sealing (UL 94 V-0)

**Features**

- High pulse strength and high contact reliability
- Very low inductance
- RoHS-compatible

**Terminals**

- Strap terminals, tinned copper or brass (max. torque 10 Nm)

**Marking**

Manufacturer's logo, ordering code, style (MKP)  
rated capacitance (coded), cap. tolerance (code letter),  
rated DC voltage, date of manufacture (coded)

**Delivery mode**

Bulk (untaped)

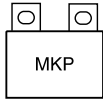

**Dimensional drawings**

**T1 (code no. 561)**



**T2 (code no. 562)**



**T3 (code no. 563)**



**T4 (code no. 564)**

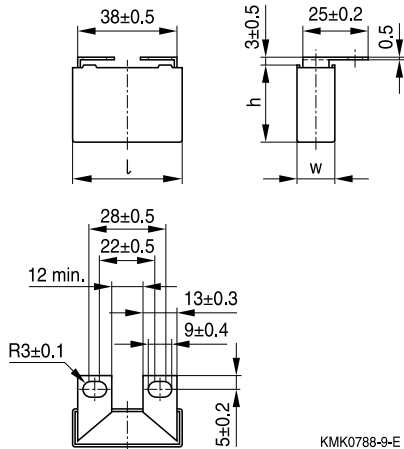

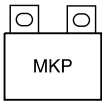

**B32656S ... B32658S**

**Snubber (wound)**

**Dimensional drawings (continued)**

**T5 (code no. 565)**



**T6 (code no. 566)**



**T7 (code no. 577)**

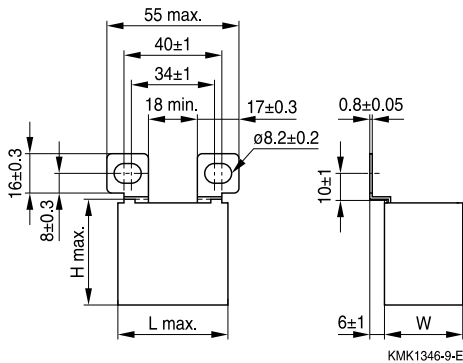

**T8 (code no. 408)**

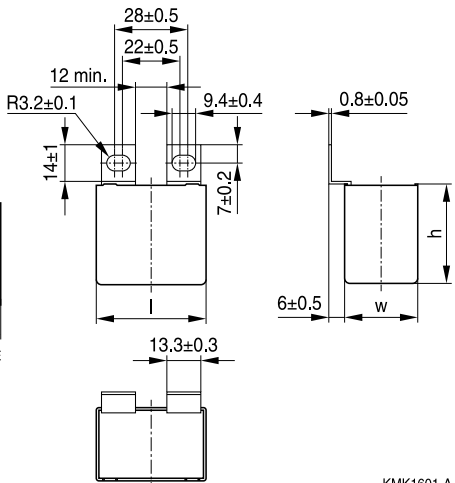

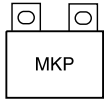

**Dimensional drawings (continued)**

**T9 (code no. 409)**

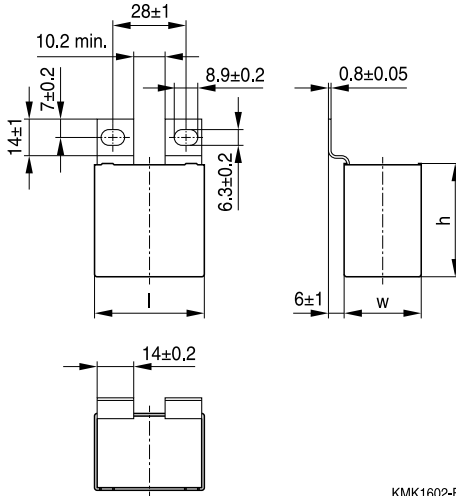

KMK1602-B

**T10 (code no. 410)**

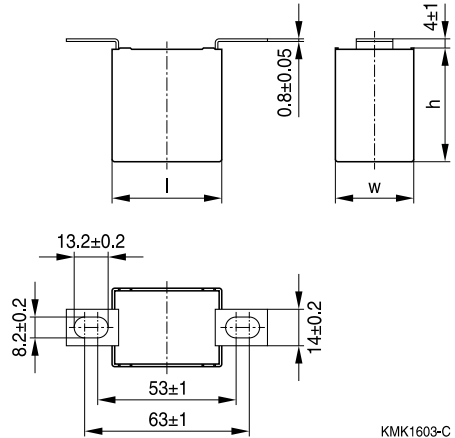

KMK1603-C

**T11 (code no. 411)**

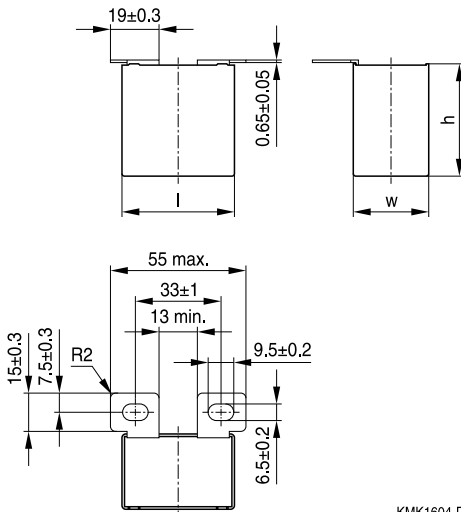

KMK1604-D

**T12 (code no. 412)**

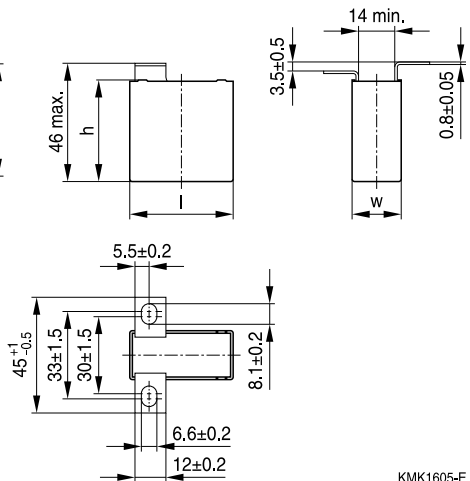

KMK1605-E



B32656S ... B32658S

Snubber (wound)

Dimensional drawings (continued)

T14 (code no. 414)

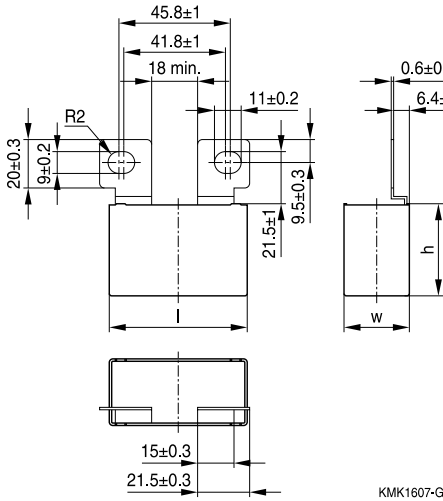

T15 (code no. 415)



T16 (code no. 416)

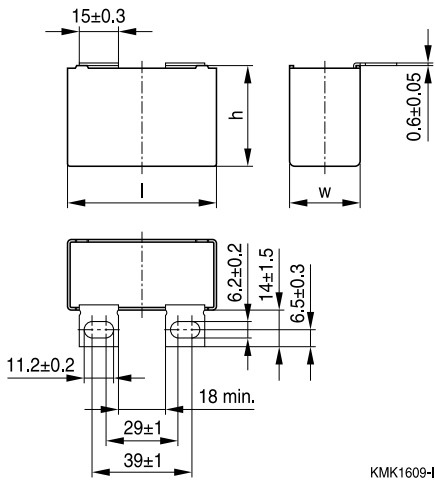

T17 (code no. 417)



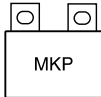

Dimensional drawings (continued)

T18 (code no. 418)

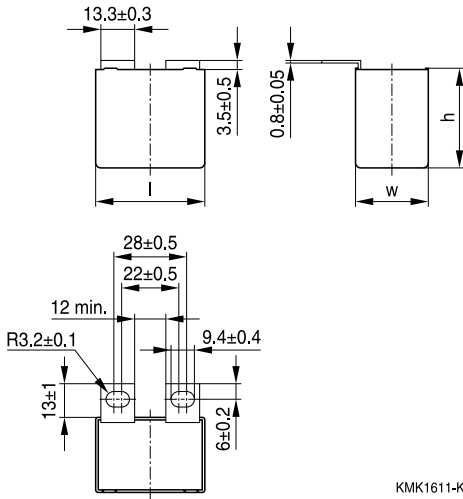

KMK1611-K



**B32656S ... B32658S**

**Snubber (wound)**

**Overview of available types**

| Type             | B32656S |      |      |      |      |
|------------------|---------|------|------|------|------|
| $V_R$ (V DC)     | 850     | 1000 | 1250 | 1700 | 2000 |
| $V_{RMS}$ (V AC) | 450     | 480  | 500  | 750  | 800  |
| $C_R$ (nF)       |         |      |      |      |      |
| 68               |         |      |      |      |      |
| 100              |         |      |      |      |      |
| 120              |         |      |      |      |      |
| 150              |         |      |      |      |      |
| 220              |         |      |      |      |      |
| 270              |         |      |      |      |      |
| 330              |         |      |      |      |      |
| 390              |         |      |      |      |      |
| 470              |         |      |      |      |      |
| 560              |         |      |      |      |      |
| 680              |         |      |      |      |      |
| 820              |         |      |      |      |      |
| 1000             |         |      |      |      |      |
| 1200             |         |      |      |      |      |
| 1500             |         |      |      |      |      |
| 1800             |         |      |      |      |      |
| 2200             |         |      |      |      |      |
| 2700             |         |      |      |      |      |
| 3300             |         |      |      |      |      |



B32656S ... B32658S

Snubber (wound)

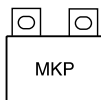

| Type             | B32658S |      |      |      |      |
|------------------|---------|------|------|------|------|
| $V_R$ (V DC)     | 850     | 1000 | 1250 | 1700 | 2000 |
| $V_{RMS}$ (V AC) | 450     | 480  | 500  | 750  | 800  |
| $C_R$ (nF)       |         |      |      |      |      |
| 330              |         |      |      |      |      |
| 470              |         |      |      |      |      |
| 680              |         |      |      |      |      |
| 820              |         |      |      |      |      |
| 900              |         |      |      |      |      |
| 1000             |         |      |      |      |      |
| 1200             |         |      |      |      |      |
| 1400             |         |      |      |      |      |
| 1500             |         |      |      |      |      |
| 1800             |         |      |      |      |      |
| 2200             |         |      |      |      |      |
| 2700             |         |      |      |      |      |
| 3000             |         |      |      |      |      |
| 3300             |         |      |      |      |      |
| 4000             |         |      |      |      |      |
| 4200             |         |      |      |      |      |
| 4500             |         |      |      |      |      |
| 4700             |         |      |      |      |      |
| 5000             |         |      |      |      |      |
| 5600             |         |      |      |      |      |

**B32656S**
**Snubber (wound)**
**Electrical specifications, ordering codes and packing units**

| $V_R$ | $V_{RMS}$<br>$f \leq 1\text{kHz}$ | $C_R$ | Max. dimensions<br>$w \times h \times l$<br>mm | $I_{RMS}$<br>100 kHz<br>A | $ESR_{typ}$<br>100 kHz<br>m $\Omega$ | Ordering code<br>(composition see<br>below) | Ter-<br>minal | pcs./<br>MOQ |
|-------|-----------------------------------|-------|--|---------------------------|--------------------------------------|---|---------------|--------------|
| V DC  | V AC                              | nF    |  |                           |                                      |   |               |              |
| 850   | 450                               | 560   | 14.0 × 25.0 × 42.0                             | 8.0                       | 9.0                                  | B32656S8564+408                             | T8            | 288          |
|       |                                   | 560   | 14.0 × 25.0 × 42.0                             | 8.0                       | 9.0                                  | B32656S8564+418                             | T18           | 288          |
|       |                                   | 560   | 14.0 × 25.0 × 42.0                             | 8.0                       | 9.0                                  | B32656S8564+563                             | T3            | 168          |
|       |                                   | 560   | 14.0 × 25.0 × 42.0                             | 8.0                       | 9.0                                  | B32656S8564+564                             | T4            | 288          |
|       |                                   | 560   | 14.0 × 25.0 × 42.0                             | 8.0                       | 9.0                                  | B32656S8564+565                             | T5            | 288          |
|       |                                   | 680   | 16.0 × 28.5 × 42.0                             | 9.5                       | 7.0                                  | B32656S8684+408                             | T8            | 192          |
|       |                                   | 680   | 16.0 × 28.5 × 42.0                             | 9.5                       | 7.0                                  | B32656S8684+409                             | T9            | 192          |
|       |                                   | 680   | 16.0 × 28.5 × 42.0                             | 9.5                       | 7.0                                  | B32656S8684+411                             | T11           | 128          |
|       |                                   | 680   | 16.0 × 28.5 × 42.0                             | 9.5                       | 7.0                                  | B32656S8684+418                             | T18           | 192          |
|       |                                   | 680   | 16.0 × 28.5 × 42.0                             | 9.5                       | 7.0                                  | B32656S8684+561                             | T1            | 192          |
|       |                                   | 680   | 16.0 × 28.5 × 42.0                             | 9.5                       | 7.0                                  | B32656S8684+562                             | T2            | 192          |
|       |                                   | 680   | 16.0 × 28.5 × 42.0                             | 9.5                       | 7.0                                  | B32656S8684+563                             | T3            | 144          |
|       |                                   | 680   | 16.0 × 28.5 × 42.0                             | 9.5                       | 7.0                                  | B32656S8684+564                             | T4            | 192          |
|       |                                   | 680   | 16.0 × 28.5 × 42.0                             | 9.5                       | 7.0                                  | B32656S8684+565                             | T5            | 192          |
|       |                                   | 680   | 16.0 × 28.5 × 42.0                             | 9.5                       | 7.0                                  | B32656S8684+566                             | T6            | 192          |
|       |                                   | 680   | 16.0 × 28.5 × 42.0                             | 9.5                       | 7.0                                  | B32656S8684+577                             | T7            | 180          |
|       |                                   | 820   | 16.0 × 28.5 × 42.0                             | 10.0                      | 6.0                                  | B32656S8824+408                             | T8            | 192          |
|       |                                   | 820   | 16.0 × 28.5 × 42.0                             | 10.0                      | 6.0                                  | B32656S8824+409                             | T9            | 192          |
|       |                                   | 820   | 16.0 × 28.5 × 42.0                             | 10.0                      | 6.0                                  | B32656S8824+411                             | T11           | 128          |
|       |                                   | 820   | 16.0 × 28.5 × 42.0                             | 10.0                      | 6.0                                  | B32656S8824+418                             | T18           | 192          |
|       |                                   | 820   | 16.0 × 28.5 × 42.0                             | 10.0                      | 6.0                                  | B32656S8824+561                             | T1            | 192          |
|       |                                   | 820   | 16.0 × 28.5 × 42.0                             | 10.0                      | 6.0                                  | B32656S8824+562                             | T2            | 192          |
|       |                                   | 820   | 16.0 × 28.5 × 42.0                             | 10.0                      | 6.0                                  | B32656S8824+563                             | T3            | 144          |
|       |                                   | 820   | 16.0 × 28.5 × 42.0                             | 10.0                      | 6.0                                  | B32656S8824+564                             | T4            | 192          |
|       |                                   | 820   | 16.0 × 28.5 × 42.0                             | 10.0                      | 6.0                                  | B32656S8824+565                             | T5            | 192          |
|       |                                   | 820   | 16.0 × 28.5 × 42.0                             | 10.0                      | 6.0                                  | B32656S8824+566                             | T6            | 192          |
|       |                                   | 820   | 16.0 × 28.5 × 42.0                             | 10.0                      | 6.0                                  | B32656S8824+577                             | T7            | 180          |

MOQ = Minimum Order Quantity, consisting of 4 packing units.

Further E series and intermediate capacitance values on request.

**Composition of ordering code**

+ = Capacitance tolerance code:

K =  $\pm 10\%$

J =  $\pm 5\%$

**Electrical specifications, ordering codes and packing units**

| $V_R$ | $V_{RMS}$<br>$f \leq 1\text{kHz}$ | $C_R$ | Max. dimensions<br>$w \times h \times l$ | $I_{RMS}$<br>100 kHz | $ESR_{typ}$<br>100 kHz | Ordering code<br>(composition see<br>below) | Ter-<br>minal | pcs./<br>MOQ |
|-------|-----------------------------------|-------|--|----------------------|------------------------|---|---------------|--------------|
| V DC  | V AC                              | nF    | mm                                       | A                    | m $\Omega$             |   |               |              |
| 850   | 450                               | 1000  | 18.0 × 32.5 × 42.0                       | 11.5                 | 6.0                    | B32656S8105+408                             | T8            | 140          |
|       |                                   | 1000  | 18.0 × 32.5 × 42.0                       | 11.5                 | 6.0                    | B32656S8105+409                             | T9            | 140          |
|       |                                   | 1000  | 18.0 × 32.5 × 42.0                       | 11.5                 | 6.0                    | B32656S8105+411                             | T11           | 112          |
|       |                                   | 1000  | 18.0 × 32.5 × 42.0                       | 11.5                 | 6.0                    | B32656S8105+418                             | T18           | 140          |
|       |                                   | 1000  | 18.0 × 32.5 × 42.0                       | 11.5                 | 6.0                    | B32656S8105+561                             | T1            | 140          |
|       |                                   | 1000  | 18.0 × 32.5 × 42.0                       | 11.5                 | 6.0                    | B32656S8105+562                             | T2            | 140          |
|       |                                   | 1000  | 18.0 × 32.5 × 42.0                       | 11.5                 | 6.0                    | B32656S8105+563                             | T3            | 120          |
|       |                                   | 1000  | 18.0 × 32.5 × 42.0                       | 11.5                 | 6.0                    | B32656S8105+564                             | T4            | 128          |
|       |                                   | 1000  | 18.0 × 32.5 × 42.0                       | 11.5                 | 6.0                    | B32656S8105+565                             | T5            | 128          |
|       |                                   | 1000  | 18.0 × 32.5 × 42.0                       | 11.5                 | 6.0                    | B32656S8105+566                             | T6            | 140          |
|       |                                   | 1000  | 18.0 × 32.5 × 42.0                       | 11.5                 | 6.0                    | B32656S8105+577                             | T7            | 156          |
|       |                                   | 1200  | 18.0 × 32.5 × 42.0                       | 12.5                 | 5.0                    | B32656S8125+408                             | T8            | 140          |
|       |                                   | 1200  | 18.0 × 32.5 × 42.0                       | 12.5                 | 5.0                    | B32656S8125+409                             | T9            | 140          |
|       |                                   | 1200  | 18.0 × 32.5 × 42.0                       | 12.5                 | 5.0                    | B32656S8125+411                             | T11           | 112          |
|       |                                   | 1200  | 18.0 × 32.5 × 42.0                       | 12.5                 | 5.0                    | B32656S8125+418                             | T18           | 140          |
|       |                                   | 1200  | 18.0 × 32.5 × 42.0                       | 12.5                 | 5.0                    | B32656S8125+561                             | T1            | 140          |
|       |                                   | 1200  | 18.0 × 32.5 × 42.0                       | 12.5                 | 5.0                    | B32656S8125+562                             | T2            | 140          |
|       |                                   | 1200  | 18.0 × 32.5 × 42.0                       | 12.5                 | 5.0                    | B32656S8125+563                             | T3            | 120          |
|       |                                   | 1200  | 18.0 × 32.5 × 42.0                       | 12.5                 | 5.0                    | B32656S8125+564                             | T4            | 128          |
|       |                                   | 1200  | 18.0 × 32.5 × 42.0                       | 12.5                 | 5.0                    | B32656S8125+565                             | T5            | 128          |
|       |                                   | 1200  | 18.0 × 32.5 × 42.0                       | 12.5                 | 5.0                    | B32656S8125+566                             | T6            | 140          |
|       |                                   | 1200  | 18.0 × 32.5 × 42.0                       | 12.5                 | 5.0                    | B32656S8125+577                             | T7            | 156          |
|       |                                   | 1500  | 31.0 × 26.5 × 43.6                       | 14.0                 | 5.0                    | B32656S8155+408                             | T8            | 128          |
|       |                                   | 1500  | 31.0 × 26.5 × 43.6                       | 14.0                 | 5.0                    | B32656S8155+409                             | T9            | 128          |
|       |                                   | 1500  | 31.0 × 26.5 × 43.6                       | 14.0                 | 5.0                    | B32656S8155+418                             | T18           | 128          |
|       |                                   | 1500  | 31.0 × 26.5 × 43.6                       | 14.0                 | 5.0                    | B32656S8155+561                             | T1            | 128          |
|       |                                   | 1500  | 31.0 × 26.5 × 43.6                       | 14.0                 | 5.0                    | B32656S8155+562                             | T2            | 128          |
|       |                                   | 1500  | 31.0 × 26.5 × 43.6                       | 14.0                 | 5.0                    | B32656S8155+563                             | T3            | 72           |
|       |                                   | 1500  | 31.0 × 26.5 × 43.6                       | 14.0                 | 5.0                    | B32656S8155+566                             | T6            | 128          |
|       |                                   | 1500  | 31.0 × 26.5 × 43.6                       | 14.0                 | 5.0                    | B32656S8155+577                             | T7            | 84           |

MOQ = Minimum Order Quantity, consisting of 4 packing units.

Further E series and intermediate capacitance values on request.

**Composition of ordering code**

+ = Capacitance tolerance code:

K =  $\pm 10\%$

J =  $\pm 5\%$

**B32656S**
**Snubber (wound)**
**Electrical specifications, ordering codes and packing units**

| $V_R$ | $V_{RMS}$<br>$f \leq 1 \text{ kHz}$ | $C_R$ | Max. dimensions<br>$w \times h \times l$<br>mm | $I_{RMS}$<br>100 kHz<br>A | $ESR_{typ}$<br>100 kHz<br>m $\Omega$ | Ordering code<br>(composition see<br>below) | Ter-<br>minal | pcs./<br>MOQ |
|-------|-------------------------------------|-------|--|---------------------------|--------------------------------------|---|---------------|--------------|
| V DC  | V AC                                | nF    |  |                           |                                      |   |               |              |
| 850   | 450                                 | 1800  | 28.0 × 37.0 × 42.0                             | 15.5                      | 4.5                                  | B32656S8185+408                             | T8            | 108          |
|       |                                     | 1800  | 28.0 × 37.0 × 42.0                             | 15.5                      | 4.5                                  | B32656S8185+409                             | T9            | 108          |
|       |                                     | 1800  | 28.0 × 37.0 × 42.0                             | 15.5                      | 4.5                                  | B32656S8185+410                             | T10           | 80           |
|       |                                     | 1800  | 28.0 × 37.0 × 42.0                             | 15.5                      | 4.5                                  | B32656S8185+411                             | T11           | 72           |
|       |                                     | 1800  | 28.0 × 37.0 × 42.0                             | 15.5                      | 4.5                                  | B32656S8185+418                             | T18           | 108          |
|       |                                     | 1800  | 28.0 × 37.0 × 42.0                             | 15.5                      | 4.5                                  | B32656S8185+561                             | T1            | 108          |
|       |                                     | 1800  | 28.0 × 37.0 × 42.0                             | 15.5                      | 4.5                                  | B32656S8185+562                             | T2            | 108          |
|       |                                     | 1800  | 28.0 × 37.0 × 42.0                             | 15.5                      | 4.5                                  | B32656S8185+563                             | T3            | 96           |
|       |                                     | 1800  | 28.0 × 37.0 × 42.0                             | 15.5                      | 4.5                                  | B32656S8185+566                             | T6            | 108          |
|       |                                     | 1800  | 28.0 × 37.0 × 42.0                             | 15.5                      | 4.5                                  | B32656S8185+577                             | T7            | 96           |
|       |                                     | 2200  | 30.0 × 45.0 × 42.0                             | 17.0                      | 4.0                                  | B32656S8225+408                             | T8            | 48           |
|       |                                     | 2200  | 30.0 × 45.0 × 42.0                             | 17.0                      | 4.0                                  | B32656S8225+409                             | T9            | 48           |
|       |                                     | 2200  | 30.0 × 45.0 × 42.0                             | 17.0                      | 4.0                                  | B32656S8225+410                             | T10           | 80           |
|       |                                     | 2200  | 30.0 × 45.0 × 42.0                             | 17.0                      | 4.0                                  | B32656S8225+411                             | T11           | 64           |
|       |                                     | 2200  | 30.0 × 45.0 × 42.0                             | 17.0                      | 4.0                                  | B32656S8225+418                             | T18           | 48           |
|       |                                     | 2200  | 30.0 × 45.0 × 42.0                             | 17.0                      | 4.0                                  | B32656S8225+561                             | T1            | 48           |
|       |                                     | 2200  | 30.0 × 45.0 × 42.0                             | 17.0                      | 4.0                                  | B32656S8225+562                             | T2            | 48           |
|       |                                     | 2200  | 30.0 × 45.0 × 42.0                             | 17.0                      | 4.0                                  | B32656S8225+563                             | T3            | 96           |
|       |                                     | 2200  | 30.0 × 45.0 × 42.0                             | 17.0                      | 4.0                                  | B32656S8225+566                             | T6            | 48           |
|       |                                     | 2200  | 30.0 × 45.0 × 42.0                             | 17.0                      | 4.0                                  | B32656S8225+577                             | T7            | 96           |
|       |                                     | 2700  | 30.0 × 45.0 × 42.0                             | 20.0                      | 3.7                                  | B32656S8275+408                             | T8            | 48           |
|       |                                     | 2700  | 30.0 × 45.0 × 42.0                             | 20.0                      | 3.7                                  | B32656S8275+409                             | T9            | 48           |
|       |                                     | 2700  | 30.0 × 45.0 × 42.0                             | 20.0                      | 3.7                                  | B32656S8275+410                             | T10           | 80           |
|       |                                     | 2700  | 30.0 × 45.0 × 42.0                             | 20.0                      | 3.7                                  | B32656S8275+411                             | T11           | 64           |
|       |                                     | 2700  | 30.0 × 45.0 × 42.0                             | 20.0                      | 3.7                                  | B32656S8275+418                             | T18           | 48           |
|       |                                     | 2700  | 30.0 × 45.0 × 42.0                             | 20.0                      | 3.7                                  | B32656S8275+561                             | T1            | 48           |
|       |                                     | 2700  | 30.0 × 45.0 × 42.0                             | 20.0                      | 3.7                                  | B32656S8275+562                             | T2            | 48           |
|       |                                     | 2700  | 30.0 × 45.0 × 42.0                             | 20.0                      | 3.7                                  | B32656S8275+563                             | T3            | 96           |
|       |                                     | 2700  | 30.0 × 45.0 × 42.0                             | 20.0                      | 3.7                                  | B32656S8275+566                             | T6            | 48           |
|       |                                     | 2700  | 30.0 × 45.0 × 42.0                             | 20.0                      | 3.7                                  | B32656S8275+577                             | T7            | 96           |

MOQ = Minimum Order Quantity, consisting of 4 packing units.

Further E series and intermediate capacitance values on request.

**Composition of ordering code**

+ = Capacitance tolerance code:

K = ±10%

J = ±5%

**Electrical specifications, ordering codes and packing units**

| $V_R$ | $V_{RMS}$<br>$f \leq 1\text{kHz}$ | $C_R$ | Max. dimensions<br>$w \times h \times l$<br>mm | $I_{RMS}$<br>100 kHz<br>A | $ESR_{typ}$<br>100 kHz<br>m $\Omega$ | Ordering code<br>(composition see<br>below) | Ter-<br>minal | pcs./<br>MOQ |
|-------|-----------------------------------|-------|--|---------------------------|--------------------------------------|---|---------------|--------------|
| V DC  | V AC                              | nF    |  |                           |                                      |   |               |              |
| 850   | 450                               | 3300  | 33.0 × 48.0 × 43.0                             | 23.0                      | 3.3                                  | B32656S8335+408                             | T8            | 84           |
|       |                                   | 3300  | 33.0 × 48.0 × 43.0                             | 23.0                      | 3.3                                  | B32656S8335+409                             | T9            | 84           |
|       |                                   | 3300  | 33.0 × 48.0 × 43.0                             | 23.0                      | 3.3                                  | B32656S8335+410                             | T10           | 60           |
|       |                                   | 3300  | 33.0 × 48.0 × 43.0                             | 23.0                      | 3.3                                  | B32656S8335+411                             | T11           | 56           |
|       |                                   | 3300  | 33.0 × 48.0 × 43.0                             | 23.0                      | 3.3                                  | B32656S8335+418                             | T18           | 84           |
|       |                                   | 3300  | 33.0 × 48.0 × 43.0                             | 23.0                      | 3.3                                  | B32656S8335+561                             | T1            | 84           |
|       |                                   | 3300  | 33.0 × 48.0 × 43.0                             | 23.0                      | 3.3                                  | B32656S8335+562                             | T2            | 84           |
|       |                                   | 3300  | 33.0 × 48.0 × 43.0                             | 23.0                      | 3.3                                  | B32656S8335+563                             | T3            | 64           |
|       |                                   | 3300  | 33.0 × 48.0 × 43.0                             | 23.0                      | 3.3                                  | B32656S8335+566                             | T6            | 84           |
|       |                                   | 3300  | 33.0 × 48.0 × 43.0                             | 23.0                      | 3.3                                  | B32656S8335+577                             | T7            | 84           |
| 1000  | 480                               | 330   | 14.0 × 25.0 × 42.0                             | 7.0                       | 13.0                                 | B32656S0334+408                             | T8            | 288          |
|       |                                   | 330   | 14.0 × 25.0 × 42.0                             | 7.0                       | 13.0                                 | B32656S0334+418                             | T18           | 288          |
|       |                                   | 330   | 14.0 × 25.0 × 42.0                             | 7.0                       | 13.0                                 | B32656S0334+563                             | T3            | 168          |
|       |                                   | 330   | 14.0 × 25.0 × 42.0                             | 7.0                       | 13.0                                 | B32656S0334+564                             | T4            | 288          |
|       |                                   | 330   | 14.0 × 25.0 × 42.0                             | 7.0                       | 13.0                                 | B32656S0334+565                             | T5            | 288          |
|       |                                   | 390   | 14.0 × 25.0 × 42.0                             | 7.5                       | 11.0                                 | B32656S0394+408                             | T8            | 288          |
|       |                                   | 390   | 14.0 × 25.0 × 42.0                             | 7.5                       | 11.0                                 | B32656S0394+418                             | T18           | 288          |
|       |                                   | 390   | 14.0 × 25.0 × 42.0                             | 7.5                       | 11.0                                 | B32656S0394+563                             | T3            | 168          |
|       |                                   | 390   | 14.0 × 25.0 × 42.0                             | 7.5                       | 11.0                                 | B32656S0394+564                             | T4            | 288          |
|       |                                   | 390   | 14.0 × 25.0 × 42.0                             | 7.5                       | 11.0                                 | B32656S0394+565                             | T5            | 288          |
|       |                                   | 470   | 14.0 × 25.0 × 42.0                             | 8.0                       | 10.0                                 | B32656S0474+408                             | T8            | 288          |
|       |                                   | 470   | 14.0 × 25.0 × 42.0                             | 8.0                       | 10.0                                 | B32656S0474+418                             | T18           | 288          |
|       |                                   | 470   | 14.0 × 25.0 × 42.0                             | 8.0                       | 10.0                                 | B32656S0474+563                             | T3            | 168          |
|       |                                   | 470   | 14.0 × 25.0 × 42.0                             | 8.0                       | 10.0                                 | B32656S0474+564                             | T4            | 288          |
|       |                                   | 470   | 14.0 × 25.0 × 42.0                             | 8.0                       | 10.0                                 | B32656S0474+565                             | T5            | 288          |
|       |                                   | 560   | 16.0 × 28.5 × 42.0                             | 9.0                       | 8.0                                  | B32656S0564+408                             | T8            | 192          |
|       |                                   | 560   | 16.0 × 28.5 × 42.0                             | 9.0                       | 8.0                                  | B32656S0564+409                             | T9            | 192          |
|       |                                   | 560   | 16.0 × 28.5 × 42.0                             | 9.0                       | 8.0                                  | B32656S0564+411                             | T11           | 128          |
|       |                                   | 560   | 16.0 × 28.5 × 42.0                             | 9.0                       | 8.0                                  | B32656S0564+418                             | T18           | 192          |

MOQ = Minimum Order Quantity, consisting of 4 packing units.

Further E series and intermediate capacitance values on request.

**Composition of ordering code**

+ = Capacitance tolerance code:

K = ±10%

J = ±5%

**B32656S**
**Snubber (wound)**
**Electrical specifications, ordering codes and packing units**

| $V_R$ | $V_{RMS}$<br>$f \leq 1 \text{ kHz}$ | $C_R$ | Max. dimensions<br>$w \times h \times l$<br>mm | $I_{RMS}$<br>100 kHz<br>A | ESR <sub>typ</sub><br>100 kHz<br>mΩ | Ordering code<br>(composition see<br>below) | Ter-<br>minal | pcs./<br>MOQ |
|-------|-------------------------------------|-------|--|---------------------------|-------------------------------------|---|---------------|--------------|
| V DC  | V AC                                | nF    |  |                           |                                     |   |               |              |
| 1000  | 480                                 | 560   | 16.0 × 28.5 × 42.0                             | 9.0                       | 8.0                                 | B32656S0564+561                             | T1            | 192          |
|       |                                     | 560   | 16.0 × 28.5 × 42.0                             | 9.0                       | 8.0                                 | B32656S0564+562                             | T2            | 192          |
|       |                                     | 560   | 16.0 × 28.5 × 42.0                             | 9.0                       | 8.0                                 | B32656S0564+563                             | T3            | 144          |
|       |                                     | 560   | 16.0 × 28.5 × 42.0                             | 9.0                       | 8.0                                 | B32656S0564+564                             | T4            | 192          |
|       |                                     | 560   | 16.0 × 28.5 × 42.0                             | 9.0                       | 8.0                                 | B32656S0564+565                             | T5            | 192          |
|       |                                     | 560   | 16.0 × 28.5 × 42.0                             | 9.0                       | 8.0                                 | B32656S0564+566                             | T6            | 192          |
|       |                                     | 560   | 16.0 × 28.5 × 42.0                             | 9.0                       | 8.0                                 | B32656S0564+577                             | T7            | 180          |
|       |                                     | 680   | 16.0 × 28.5 × 42.0                             | 10.5                      | 6.5                                 | B32656S0684+408                             | T8            | 192          |
|       |                                     | 680   | 16.0 × 28.5 × 42.0                             | 10.5                      | 6.5                                 | B32656S0684+409                             | T9            | 192          |
|       |                                     | 680   | 16.0 × 28.5 × 42.0                             | 10.5                      | 6.5                                 | B32656S0684+411                             | T11           | 128          |
|       |                                     | 680   | 16.0 × 28.5 × 42.0                             | 10.5                      | 6.5                                 | B32656S0684+418                             | T18           | 192          |
|       |                                     | 680   | 16.0 × 28.5 × 42.0                             | 10.5                      | 6.5                                 | B32656S0684+561                             | T1            | 192          |
|       |                                     | 680   | 16.0 × 28.5 × 42.0                             | 10.5                      | 6.5                                 | B32656S0684+562                             | T2            | 192          |
|       |                                     | 680   | 16.0 × 28.5 × 42.0                             | 10.5                      | 6.5                                 | B32656S0684+563                             | T3            | 144          |
|       |                                     | 680   | 16.0 × 28.5 × 42.0                             | 10.5                      | 6.5                                 | B32656S0684+564                             | T4            | 192          |
|       |                                     | 680   | 16.0 × 28.5 × 42.0                             | 10.5                      | 6.5                                 | B32656S0684+565                             | T5            | 192          |
|       |                                     | 680   | 16.0 × 28.5 × 42.0                             | 10.5                      | 6.5                                 | B32656S0684+566                             | T6            | 192          |
|       |                                     | 680   | 16.0 × 28.5 × 42.0                             | 10.5                      | 6.5                                 | B32656S0684+577                             | T7            | 180          |
|       |                                     | 680   | 19.0 × 37.5 × 42.0                             | 18.0                      | 3.0                                 | B32656S0684+412                             | T12           | 264          |
|       |                                     | 820   | 18.0 × 32.5 × 42.0                             | 11.5                      | 6.0                                 | B32656S0824+408                             | T8            | 140          |
|       |                                     | 820   | 18.0 × 32.5 × 42.0                             | 11.5                      | 6.0                                 | B32656S0824+409                             | T9            | 140          |
|       |                                     | 820   | 18.0 × 32.5 × 42.0                             | 11.5                      | 6.0                                 | B32656S0824+411                             | T11           | 112          |
|       |                                     | 820   | 18.0 × 32.5 × 42.0                             | 11.5                      | 6.0                                 | B32656S0824+418                             | T18           | 140          |
|       |                                     | 820   | 18.0 × 32.5 × 42.0                             | 11.5                      | 6.0                                 | B32656S0824+561                             | T1            | 140          |
|       |                                     | 820   | 18.0 × 32.5 × 42.0                             | 11.5                      | 6.0                                 | B32656S0824+562                             | T2            | 140          |
|       |                                     | 820   | 18.0 × 32.5 × 42.0                             | 11.5                      | 6.0                                 | B32656S0824+563                             | T3            | 120          |
|       |                                     | 820   | 18.0 × 32.5 × 42.0                             | 11.5                      | 6.0                                 | B32656S0824+564                             | T4            | 128          |
|       |                                     | 820   | 18.0 × 32.5 × 42.0                             | 11.5                      | 6.0                                 | B32656S0824+565                             | T5            | 128          |
|       |                                     | 820   | 18.0 × 32.5 × 42.0                             | 11.5                      | 6.0                                 | B32656S0824+566                             | T6            | 140          |
|       |                                     | 820   | 18.0 × 32.5 × 42.0                             | 11.5                      | 6.0                                 | B32656S0824+577                             | T7            | 156          |
|       |                                     | 1000  | 20.0 × 39.5 × 42.0                             | 13.0                      | 6.0                                 | B32656S0105+408                             | T8            | 96           |
|       |                                     | 1000  | 20.0 × 39.5 × 42.0                             | 13.0                      | 6.0                                 | B32656S0105+409                             | T9            | 96           |
|       |                                     | 1000  | 20.0 × 39.5 × 42.0                             | 13.0                      | 6.0                                 | B32656S0105+410                             | T10           | 120          |

MOQ = Minimum Order Quantity, consisting of 4 packing units.

Further E series and intermediate capacitance values on request.

**Composition of ordering code**

+ = Capacitance tolerance code:

K = ±10%

J = ±5%

B32656S

Snubber (wound)



**Electrical specifications, ordering codes and packing units**

| $V_R$ | $V_{RMS}$<br>$f \leq 1\text{kHz}$ | $C_R$ | Max. dimensions<br>$w \times h \times l$ | $I_{RMS}$<br>100 kHz | $ESR_{typ}$<br>100 kHz | Ordering code<br>(composition see<br>below) | Ter-<br>minal | pcs./<br>MOQ |
|-------|-----------------------------------|-------|--|----------------------|------------------------|---|---------------|--------------|
| V DC  | V AC                              | nF    | mm                                       | A                    | m $\Omega$             |   |               |              |
| 1000  | 480                               | 1000  | 20.0 × 39.5 × 42.0                       | 13.0                 | 6.0                    | B32656S0105+411                             | T11           | 96           |
|       |                                   | 1000  | 20.0 × 39.5 × 42.0                       | 13.0                 | 6.0                    | B32656S0105+418                             | T18           | 96           |
|       |                                   | 1000  | 20.0 × 39.5 × 42.0                       | 13.0                 | 6.0                    | B32656S0105+561                             | T1            | 96           |
|       |                                   | 1000  | 20.0 × 39.5 × 42.0                       | 13.0                 | 6.0                    | B32656S0105+562                             | T2            | 96           |
|       |                                   | 1000  | 20.0 × 39.5 × 42.0                       | 13.0                 | 6.0                    | B32656S0105+563                             | T3            | 104          |
|       |                                   | 1000  | 20.0 × 39.5 × 42.0                       | 13.0                 | 6.0                    | B32656S0105+564                             | T4            | 96           |
|       |                                   | 1000  | 20.0 × 39.5 × 42.0                       | 13.0                 | 6.0                    | B32656S0105+565                             | T5            | 96           |
|       |                                   | 1000  | 20.0 × 39.5 × 42.0                       | 13.0                 | 6.0                    | B32656S0105+566                             | T6            | 96           |
|       |                                   | 1000  | 20.0 × 39.5 × 42.0                       | 13.0                 | 6.0                    | B32656S0105+577                             | T7            | 144          |
|       |                                   | 1200  | 20.0 × 39.5 × 42.0                       | 14.0                 | 5.0                    | B32656S0125+408                             | T8            | 96           |
|       |                                   | 1200  | 20.0 × 39.5 × 42.0                       | 14.0                 | 5.0                    | B32656S0125+409                             | T9            | 96           |
|       |                                   | 1200  | 20.0 × 39.5 × 42.0                       | 14.0                 | 5.0                    | B32656S0125+410                             | T10           | 120          |
|       |                                   | 1200  | 20.0 × 39.5 × 42.0                       | 14.0                 | 5.0                    | B32656S0125+411                             | T11           | 96           |
|       |                                   | 1200  | 20.0 × 39.5 × 42.0                       | 14.0                 | 5.0                    | B32656S0125+418                             | T18           | 96           |
|       |                                   | 1200  | 20.0 × 39.5 × 42.0                       | 14.0                 | 5.0                    | B32656S0125+561                             | T1            | 96           |
|       |                                   | 1200  | 20.0 × 39.5 × 42.0                       | 14.0                 | 5.0                    | B32656S0125+562                             | T2            | 96           |
|       |                                   | 1200  | 20.0 × 39.5 × 42.0                       | 14.0                 | 5.0                    | B32656S0125+563                             | T3            | 104          |
|       |                                   | 1200  | 20.0 × 39.5 × 42.0                       | 14.0                 | 5.0                    | B32656S0125+564                             | T4            | 96           |
|       |                                   | 1200  | 20.0 × 39.5 × 42.0                       | 14.0                 | 5.0                    | B32656S0125+565                             | T5            | 96           |
|       |                                   | 1200  | 20.0 × 39.5 × 42.0                       | 14.0                 | 5.0                    | B32656S0125+566                             | T6            | 96           |
|       |                                   | 1200  | 20.0 × 39.5 × 42.0                       | 14.0                 | 5.0                    | B32656S0125+577                             | T7            | 144          |
|       |                                   | 1500  | 30.0 × 45.0 × 42.0                       | 16.5                 | 5.0                    | B32656S0155+408                             | T8            | 48           |
|       |                                   | 1500  | 30.0 × 45.0 × 42.0                       | 16.5                 | 5.0                    | B32656S0155+409                             | T9            | 48           |
|       |                                   | 1500  | 30.0 × 45.0 × 42.0                       | 16.5                 | 5.0                    | B32656S0155+410                             | T10           | 80           |
|       |                                   | 1500  | 30.0 × 45.0 × 42.0                       | 16.5                 | 5.0                    | B32656S0155+411                             | T11           | 64           |
|       |                                   | 1500  | 30.0 × 45.0 × 42.0                       | 16.5                 | 5.0                    | B32656S0155+418                             | T18           | 48           |
|       |                                   | 1500  | 30.0 × 45.0 × 42.0                       | 16.5                 | 5.0                    | B32656S0155+561                             | T1            | 48           |
|       |                                   | 1500  | 30.0 × 45.0 × 42.0                       | 16.5                 | 5.0                    | B32656S0155+562                             | T2            | 48           |
|       |                                   | 1500  | 30.0 × 45.0 × 42.0                       | 16.5                 | 5.0                    | B32656S0155+563                             | T3            | 96           |
|       |                                   | 1500  | 30.0 × 45.0 × 42.0                       | 16.5                 | 5.0                    | B32656S0155+566                             | T6            | 48           |
|       |                                   | 1500  | 30.0 × 45.0 × 42.0                       | 16.5                 | 5.0                    | B32656S0155+577                             | T7            | 96           |

MOQ = Minimum Order Quantity, consisting of 4 packing units.  
Further E series and intermediate capacitance values on request.

**Composition of ordering code**

+ = Capacitance tolerance code:

K = ±10%

J = ±5%

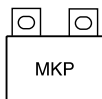
**B32656S**
**Snubber (wound)**
**Electrical specifications, ordering codes and packing units**

| $V_R$ | $V_{RMS}$<br>$f \leq 1\text{kHz}$ | $C_R$ | Max. dimensions<br>$w \times h \times l$ | $I_{RMS}$<br>100 kHz | $ESR_{typ}$<br>100 kHz | Ordering code<br>(composition see<br>below) | Ter-<br>minal | pcs./<br>MOQ |
|-------|-----------------------------------|-------|--|----------------------|------------------------|---|---------------|--------------|
| V DC  | V AC                              | nF    | mm                                       | A                    | m $\Omega$             |   |               |              |
| 1000  | 480                               | 1800  | 30.0 × 45.0 × 42.0                       | 17.0                 | 4.5                    | B32656S0185+408                             | T8            | 48           |
|       |                                   | 1800  | 30.0 × 45.0 × 42.0                       | 17.0                 | 4.5                    | B32656S0185+409                             | T9            | 48           |
|       |                                   | 1800  | 30.0 × 45.0 × 42.0                       | 17.0                 | 4.5                    | B32656S0185+410                             | T10           | 48           |
|       |                                   | 1800  | 30.0 × 45.0 × 42.0                       | 17.0                 | 4.5                    | B32656S0185+411                             | T11           | 64           |
|       |                                   | 1800  | 30.0 × 45.0 × 42.0                       | 17.0                 | 4.5                    | B32656S0185+418                             | T18           | 48           |
|       |                                   | 1800  | 30.0 × 45.0 × 42.0                       | 17.0                 | 4.5                    | B32656S0185+561                             | T1            | 48           |
|       |                                   | 1800  | 30.0 × 45.0 × 42.0                       | 17.0                 | 4.5                    | B32656S0185+562                             | T2            | 48           |
|       |                                   | 1800  | 30.0 × 45.0 × 42.0                       | 17.0                 | 4.5                    | B32656S0185+563                             | T3            | 96           |
|       |                                   | 1800  | 30.0 × 45.0 × 42.0                       | 17.0                 | 4.5                    | B32656S0185+566                             | T6            | 48           |
|       |                                   | 1800  | 30.0 × 45.0 × 42.0                       | 17.0                 | 4.5                    | B32656S0185+577                             | T7            | 96           |
|       |                                   | 2200  | 30.0 × 45.0 × 42.0                       | 19.0                 | 4.0                    | B32656S0225+408                             | T8            | 48           |
|       |                                   | 2200  | 30.0 × 45.0 × 42.0                       | 19.0                 | 4.0                    | B32656S0225+409                             | T9            | 48           |
|       |                                   | 2200  | 30.0 × 45.0 × 42.0                       | 19.0                 | 4.0                    | B32656S0225+410                             | T10           | 80           |
|       |                                   | 2200  | 30.0 × 45.0 × 42.0                       | 19.0                 | 4.0                    | B32656S0225+411                             | T11           | 64           |
|       |                                   | 2200  | 30.0 × 45.0 × 42.0                       | 19.0                 | 4.0                    | B32656S0225+418                             | T18           | 48           |
|       |                                   | 2200  | 30.0 × 45.0 × 42.0                       | 19.0                 | 4.0                    | B32656S0225+561                             | T1            | 48           |
|       |                                   | 2200  | 30.0 × 45.0 × 42.0                       | 19.0                 | 4.0                    | B32656S0225+562                             | T2            | 48           |
|       |                                   | 2200  | 30.0 × 45.0 × 42.0                       | 19.0                 | 4.0                    | B32656S0225+563                             | T3            | 96           |
|       |                                   | 2200  | 30.0 × 45.0 × 42.0                       | 19.0                 | 4.0                    | B32656S0225+566                             | T6            | 48           |
|       |                                   | 2200  | 30.0 × 45.0 × 42.0                       | 19.0                 | 4.0                    | B32656S0225+577                             | T7            | 96           |
|       |                                   | 2700  | 33.0 × 48.0 × 43.0                       | 22.0                 | 3.3                    | B32656S0275+408                             | T8            | 84           |
|       |                                   | 2700  | 33.0 × 48.0 × 43.0                       | 22.0                 | 3.3                    | B32656S0275+409                             | T9            | 84           |
|       |                                   | 2700  | 33.0 × 48.0 × 43.0                       | 22.0                 | 3.3                    | B32656S0275+410                             | T10           | 60           |
|       |                                   | 2700  | 33.0 × 48.0 × 43.0                       | 22.0                 | 3.3                    | B32656S0275+411                             | T11           | 56           |
|       |                                   | 2700  | 33.0 × 48.0 × 43.0                       | 22.0                 | 3.3                    | B32656S0275+418                             | T18           | 84           |
|       |                                   | 2700  | 33.0 × 48.0 × 43.0                       | 22.0                 | 3.3                    | B32656S0275+561                             | T1            | 84           |
|       |                                   | 2700  | 33.0 × 48.0 × 43.0                       | 22.0                 | 3.3                    | B32656S0275+562                             | T2            | 84           |
|       |                                   | 2700  | 33.0 × 48.0 × 43.0                       | 22.0                 | 3.3                    | B32656S0275+563                             | T3            | 64           |
|       |                                   | 2700  | 33.0 × 48.0 × 43.0                       | 22.0                 | 3.3                    | B32656S0275+566                             | T6            | 84           |
|       |                                   | 2700  | 33.0 × 48.0 × 43.0                       | 22.0                 | 3.3                    | B32656S0275+577                             | T7            | 84           |

MOQ = Minimum Order Quantity, consisting of 4 packing units.

Further E series and intermediate capacitance values on request.

**Composition of ordering code**

+ = Capacitance tolerance code:

K = ±10%

J = ±5%





**B32656S**  
**Snubber (wound)**

**Electrical specifications, ordering codes and packing units**

| $V_R$ | $V_{RMS}$<br>$f \leq 1\text{kHz}$ | $C_R$ | Max. dimensions<br>$w \times h \times l$<br>mm | $I_{RMS}$<br>100 kHz<br>A | ESR <sub>typ</sub><br>100 kHz<br>mΩ | Ordering code<br>(composition see<br>below) | Ter-<br>minal | pcs./<br>MOQ |
|-------|-----------------------------------|-------|--|---------------------------|-------------------------------------|---|---------------|--------------|
| V DC  | V AC                              | nF    |  |                           |                                     |   |               |              |
| 1250  | 500                               | 220   | 14.0 × 25.0 × 42.0                             | 7.0                       | 11.5                                | B32656S7224+408                             | T8            | 288          |
|       |                                   | 220   | 14.0 × 25.0 × 42.0                             | 7.0                       | 11.5                                | B32656S7224+418                             | T18           | 288          |
|       |                                   | 220   | 14.0 × 25.0 × 42.0                             | 7.0                       | 11.5                                | B32656S7224+563                             | T3            | 168          |
|       |                                   | 220   | 14.0 × 25.0 × 42.0                             | 7.0                       | 11.5                                | B32656S7224+564                             | T4            | 288          |
|       |                                   | 220   | 14.0 × 25.0 × 42.0                             | 7.0                       | 11.5                                | B32656S7224+565                             | T5            | 288          |
|       |                                   | 270   | 14.0 × 25.0 × 42.0                             | 8.0                       | 10.0                                | B32656S7274+408                             | T8            | 288          |
|       |                                   | 270   | 14.0 × 25.0 × 42.0                             | 8.0                       | 10.0                                | B32656S7274+418                             | T18           | 288          |
|       |                                   | 270   | 14.0 × 25.0 × 42.0                             | 8.0                       | 10.0                                | B32656S7274+563                             | T3            | 168          |
|       |                                   | 270   | 14.0 × 25.0 × 42.0                             | 8.0                       | 10.0                                | B32656S7274+564                             | T4            | 288          |
|       |                                   | 270   | 14.0 × 25.0 × 42.0                             | 8.0                       | 10.0                                | B32656S7274+565                             | T5            | 288          |
|       |                                   | 330   | 16.0 × 28.5 × 42.0                             | 8.5                       | 9.5                                 | B32656S7334+408                             | T8            | 192          |
|       |                                   | 330   | 16.0 × 28.5 × 42.0                             | 8.5                       | 9.5                                 | B32656S7334+409                             | T9            | 192          |
|       |                                   | 330   | 16.0 × 28.5 × 42.0                             | 8.5                       | 9.5                                 | B32656S7334+411                             | T11           | 128          |
|       |                                   | 330   | 16.0 × 28.5 × 42.0                             | 8.5                       | 9.5                                 | B32656S7334+418                             | T18           | 192          |
|       |                                   | 330   | 16.0 × 28.5 × 42.0                             | 8.5                       | 9.5                                 | B32656S7334+561                             | T1            | 192          |
|       |                                   | 330   | 16.0 × 28.5 × 42.0                             | 8.5                       | 9.5                                 | B32656S7334+562                             | T2            | 192          |
|       |                                   | 330   | 16.0 × 28.5 × 42.0                             | 8.5                       | 9.5                                 | B32656S7334+563                             | T3            | 144          |
|       |                                   | 330   | 16.0 × 28.5 × 42.0                             | 8.5                       | 9.5                                 | B32656S7334+564                             | T4            | 192          |
|       |                                   | 330   | 16.0 × 28.5 × 42.0                             | 8.5                       | 9.5                                 | B32656S7334+565                             | T5            | 192          |
|       |                                   | 330   | 16.0 × 28.5 × 42.0                             | 8.5                       | 9.5                                 | B32656S7334+566                             | T6            | 192          |
|       |                                   | 330   | 16.0 × 28.5 × 42.0                             | 8.5                       | 9.5                                 | B32656S7334+577                             | T7            | 180          |
|       |                                   | 390   | 18.0 × 32.5 × 42.0                             | 9.0                       | 9.0                                 | B32656S7394+408                             | T8            | 140          |
|       |                                   | 390   | 18.0 × 32.5 × 42.0                             | 9.0                       | 9.0                                 | B32656S7394+409                             | T9            | 140          |
|       |                                   | 390   | 18.0 × 32.5 × 42.0                             | 9.0                       | 9.0                                 | B32656S7394+411                             | T11           | 112          |
|       |                                   | 390   | 18.0 × 32.5 × 42.0                             | 9.0                       | 9.0                                 | B32656S7394+418                             | T18           | 140          |
|       |                                   | 390   | 18.0 × 32.5 × 42.0                             | 9.0                       | 9.0                                 | B32656S7394+561                             | T1            | 140          |
|       |                                   | 390   | 18.0 × 32.5 × 42.0                             | 9.0                       | 9.0                                 | B32656S7394+562                             | T2            | 140          |
|       |                                   | 390   | 18.0 × 32.5 × 42.0                             | 9.0                       | 9.0                                 | B32656S7394+563                             | T3            | 120          |
|       |                                   | 390   | 18.0 × 32.5 × 42.0                             | 9.0                       | 9.0                                 | B32656S7394+564                             | T4            | 128          |
|       |                                   | 390   | 18.0 × 32.5 × 42.0                             | 9.0                       | 9.0                                 | B32656S7394+565                             | T5            | 128          |
|       |                                   | 390   | 18.0 × 32.5 × 42.0                             | 9.0                       | 9.0                                 | B32656S7394+566                             | T6            | 140          |
|       |                                   | 390   | 18.0 × 32.5 × 42.0                             | 9.0                       | 9.0                                 | B32656S7394+577                             | T7            | 156          |

MOQ = Minimum Order Quantity, consisting of 4 packing units.  
Further E series and intermediate capacitance values on request.

**Composition of ordering code**

+ = Capacitance tolerance code:

K = ±10%

J = ±5%

**B32656S**
**Snubber (wound)**
**Electrical specifications, ordering codes and packing units**

| $V_R$ | $V_{RMS}$<br>$f \leq 1 \text{ kHz}$ | $C_R$ | Max. dimensions<br>$w \times h \times l$<br>mm | $I_{RMS}$<br>100 kHz<br>A | ESR <sub>typ</sub><br>100 kHz<br>m $\Omega$ | Ordering code<br>(composition see<br>below) | Ter-<br>minal | pcs./<br>MOQ    |     |     |
|-------|-------------------------------------|-------|--|---------------------------|---|---|---------------|-----------------|-----|-----|
| V DC  | V AC                                | nF    |  |                           |   |   |               |                 |     |     |
| 1250  | 500                                 | 470   | 18.0 × 32.5 × 42.0                             | 9.0                       | 8.5   | B32656S7474+408                             | T8            | 140             |     |     |
|       |                                     | 470   | 18.0 × 32.5 × 42.0                             | 9.0                       | 8.5   | B32656S7474+409                             | T9            | 140             |     |     |
|       |                                     | 470   | 18.0 × 32.5 × 42.0                             | 9.0                       | 8.5   | B32656S7474+411                             | T11           | 112             |     |     |
|       |                                     | 470   | 18.0 × 32.5 × 42.0                             | 9.0                       | 8.5   | B32656S7474+418                             | T18           | 140             |     |     |
|       |                                     | 470   | 18.0 × 32.5 × 42.0                             | 9.0                       | 8.5   | B32656S7474+561                             | T1            | 140             |     |     |
|       |                                     | 470   | 18.0 × 32.5 × 42.0                             | 9.0                       | 8.5   | B32656S7474+562                             | T2            | 140             |     |     |
|       |                                     | 470   | 18.0 × 32.5 × 42.0                             | 9.0                       | 8.5   | B32656S7474+563                             | T3            | 120             |     |     |
|       |                                     | 470   | 18.0 × 32.5 × 42.0                             | 9.0                       | 8.5   | B32656S7474+564                             | T4            | 128             |     |     |
|       |                                     | 470   | 18.0 × 32.5 × 42.0                             | 9.0                       | 8.5   | B32656S7474+565                             | T5            | 128             |     |     |
|       |                                     | 470   | 18.0 × 32.5 × 42.0                             | 9.0                       | 8.5   | B32656S7474+566                             | T6            | 140             |     |     |
|       |                                     | 470   | 18.0 × 32.5 × 42.0                             | 9.0                       | 8.5   | B32656S7474+577                             | T7            | 156             |     |     |
|       |                                     | 470   | 19.0 × 37.5 × 42.0                             | 17.0                      | 4.0   | B32656S7474+412                             | T12           | 264             |     |     |
|       |                                     |       |  | 560                       | 20.0 × 39.5 × 42.0                          | 11.0  | 7.0           | B32656S7564+408 | T8  | 96  |
|       |                                     |       |  | 560                       | 20.0 × 39.5 × 42.0                          | 11.0  | 7.0           | B32656S7564+409 | T9  | 96  |
|       |                                     |       |  | 560                       | 20.0 × 39.5 × 42.0                          | 11.0  | 7.0           | B32656S7564+410 | T10 | 120 |
|       |                                     |       |  | 560                       | 20.0 × 39.5 × 42.0                          | 11.0  | 7.0           | B32656S7564+411 | T11 | 96  |
|       |                                     |       |  | 560                       | 20.0 × 39.5 × 42.0                          | 11.0  | 7.0           | B32656S7564+418 | T18 | 96  |
|       |                                     |       |  | 560                       | 20.0 × 39.5 × 42.0                          | 11.0  | 7.0           | B32656S7564+561 | T1  | 96  |
|       |                                     |       |  | 560                       | 20.0 × 39.5 × 42.0                          | 11.0  | 7.0           | B32656S7564+562 | T2  | 96  |
|       |                                     |       |  | 560                       | 20.0 × 39.5 × 42.0                          | 11.0  | 7.0           | B32656S7564+563 | T3  | 104 |
|       |                                     |       |  | 560                       | 20.0 × 39.5 × 42.0                          | 11.0  | 7.0           | B32656S7564+564 | T4  | 96  |
|       |                                     |       |  | 560                       | 20.0 × 39.5 × 42.0                          | 11.0  | 7.0           | B32656S7564+565 | T5  | 96  |
|       |                                     |       |  | 560                       | 20.0 × 39.5 × 42.0                          | 11.0  | 7.0           | B32656S7564+566 | T6  | 96  |
|       |                                     |       |  | 560                       | 20.0 × 39.5 × 42.0                          | 11.0  | 7.0           | B32656S7564+577 | T7  | 144 |
|       |                                     |       |  | 680                       | 20.0 × 39.5 × 42.0                          | 13.0  | 6.0           | B32656S7684+408 | T8  | 96  |
|       |                                     |       |  | 680                       | 20.0 × 39.5 × 42.0                          | 13.0  | 6.0           | B32656S7684+409 | T9  | 96  |
|       |                                     |       |  | 680                       | 20.0 × 39.5 × 42.0                          | 13.0  | 6.0           | B32656S7684+410 | T10 | 120 |
|       |                                     |       |  | 680                       | 20.0 × 39.5 × 42.0                          | 13.0  | 6.0           | B32656S7684+411 | T11 | 96  |
|       |                                     |       |  | 680                       | 20.0 × 39.5 × 42.0                          | 13.0  | 6.0           | B32656S7684+418 | T18 | 96  |
|       |                                     |       |  | 680                       | 20.0 × 39.5 × 42.0                          | 13.0  | 6.0           | B32656S7684+561 | T1  | 96  |
|       |                                     |       |  | 680                       | 20.0 × 39.5 × 42.0                          | 13.0  | 6.0           | B32656S7684+562 | T2  | 96  |

MOQ = Minimum Order Quantity, consisting of 4 packing units.

Further E series and intermediate capacitance values on request.

**Composition of ordering code**

+ = Capacitance tolerance code:

K =  $\pm 10\%$

J =  $\pm 5\%$

B32656S

Snubber (wound)



**Electrical specifications, ordering codes and packing units**

| $V_R$ | $V_{RMS}$<br>$f \leq 1\text{kHz}$ | $C_R$ | Max. dimensions<br>$w \times h \times l$ | $I_{RMS}$<br>100 kHz | $ESR_{typ}$<br>100 kHz | Ordering code<br>(composition see<br>below) | Ter-<br>minal | pcs./<br>MOQ |
|-------|-----------------------------------|-------|--|----------------------|------------------------|---|---------------|--------------|
| V DC  | V AC                              | nF    | mm                                       | A                    | m $\Omega$             |   |               |              |
| 1250  | 500                               | 680   | 20.0 × 39.5 × 42.0                       | 13.0                 | 6.0                    | B32656S7684+563                             | T3            | 104          |
|       |                                   | 680   | 20.0 × 39.5 × 42.0                       | 13.0                 | 6.0                    | B32656S7684+564                             | T4            | 96           |
|       |                                   | 680   | 20.0 × 39.5 × 42.0                       | 13.0                 | 6.0                    | B32656S7684+565                             | T5            | 96           |
|       |                                   | 680   | 20.0 × 39.5 × 42.0                       | 13.0                 | 6.0                    | B32656S7684+566                             | T6            | 96           |
|       |                                   | 680   | 20.0 × 39.5 × 42.0                       | 13.0                 | 6.0                    | B32656S7684+577                             | T7            | 144          |
|       |                                   | 820   | 28.0 × 37.0 × 42.0                       | 14.0                 | 5.5                    | B32656S7824+408                             | T8            | 108          |
|       |                                   | 820   | 28.0 × 37.0 × 42.0                       | 14.0                 | 5.5                    | B32656S7824+409                             | T9            | 108          |
|       |                                   | 820   | 28.0 × 37.0 × 42.0                       | 14.0                 | 5.5                    | B32656S7824+410                             | T10           | 80           |
|       |                                   | 820   | 28.0 × 37.0 × 42.0                       | 14.0                 | 5.5                    | B32656S7824+411                             | T11           | 72           |
|       |                                   | 820   | 28.0 × 37.0 × 42.0                       | 14.0                 | 5.5                    | B32656S7824+418                             | T18           | 108          |
|       |                                   | 820   | 28.0 × 37.0 × 42.0                       | 14.0                 | 5.5                    | B32656S7824+561                             | T1            | 108          |
|       |                                   | 820   | 28.0 × 37.0 × 42.0                       | 14.0                 | 5.5                    | B32656S7824+562                             | T2            | 108          |
|       |                                   | 820   | 28.0 × 37.0 × 42.0                       | 14.0                 | 5.5                    | B32656S7824+563                             | T3            | 96           |
|       |                                   | 820   | 28.0 × 37.0 × 42.0                       | 14.0                 | 5.5                    | B32656S7824+566                             | T6            | 108          |
|       |                                   | 820   | 28.0 × 37.0 × 42.0                       | 14.0                 | 5.5                    | B32656S7824+577                             | T7            | 96           |
|       |                                   | 1000  | 28.0 × 37.0 × 42.0                       | 15.5                 | 5.0                    | B32656S7105+408                             | T8            | 108          |
|       |                                   | 1000  | 28.0 × 37.0 × 42.0                       | 15.5                 | 5.0                    | B32656S7105+409                             | T9            | 108          |
|       |                                   | 1000  | 28.0 × 37.0 × 42.0                       | 15.5                 | 5.0                    | B32656S7105+410                             | T10           | 80           |
|       |                                   | 1000  | 28.0 × 37.0 × 42.0                       | 15.5                 | 5.0                    | B32656S7105+411                             | T11           | 72           |
|       |                                   | 1000  | 28.0 × 37.0 × 42.0                       | 15.5                 | 5.0                    | B32656S7105+418                             | T18           | 108          |
|       |                                   | 1000  | 28.0 × 37.0 × 42.0                       | 15.5                 | 5.0                    | B32656S7105+561                             | T1            | 108          |
|       |                                   | 1000  | 28.0 × 37.0 × 42.0                       | 15.5                 | 5.0                    | B32656S7105+562                             | T2            | 108          |
|       |                                   | 1000  | 28.0 × 37.0 × 42.0                       | 15.5                 | 5.0                    | B32656S7105+563                             | T3            | 96           |
|       |                                   | 1000  | 28.0 × 37.0 × 42.0                       | 15.5                 | 5.0                    | B32656S7105+566                             | T6            | 108          |
|       |                                   | 1000  | 28.0 × 37.0 × 42.0                       | 15.5                 | 5.0                    | B32656S7105+577                             | T7            | 96           |
|       |                                   | 1200  | 30.0 × 45.0 × 42.0                       | 17.0                 | 4.5                    | B32656S7125+408                             | T8            | 48           |
|       |                                   | 1200  | 30.0 × 45.0 × 42.0                       | 17.0                 | 4.5                    | B32656S7125+409                             | T9            | 48           |
|       |                                   | 1200  | 30.0 × 45.0 × 42.0                       | 17.0                 | 4.5                    | B32656S7125+410                             | T10           | 80           |
|       |                                   | 1200  | 30.0 × 45.0 × 42.0                       | 17.0                 | 4.5                    | B32656S7125+411                             | T11           | 64           |
|       |                                   | 1200  | 30.0 × 45.0 × 42.0                       | 17.0                 | 4.5                    | B32656S7125+418                             | T18           | 48           |

MOQ = Minimum Order Quantity, consisting of 4 packing units.  
Further E series and intermediate capacitance values on request.

**Composition of ordering code**

+ = Capacitance tolerance code:

K = ±10%

J = ±5%

**B32656S**
**Snubber (wound)**
**Electrical specifications, ordering codes and packing units**

| $V_R$ | $V_{RMS}$<br>$f \leq 1\text{kHz}$ | $C_R$ | Max. dimensions<br>$w \times h \times l$ | $I_{RMS}$<br>100 kHz | $ESR_{typ}$<br>100 kHz | Ordering code<br>(composition see<br>below) | Ter-<br>minal | pcs./<br>MOQ    |     |     |
|-------|-----------------------------------|-------|--|----------------------|------------------------|---|---------------|-----------------|-----|-----|
| V DC  | V AC                              | nF    | mm                                       | A                    | $m\Omega$              |   |               |                 |     |     |
| 1250  | 500                               | 1200  | 30.0 × 45.0 × 42.0                       | 17.0                 | 4.5                    | B32656S7125+561                             | T1            | 48              |     |     |
|       |                                   | 1200  | 30.0 × 45.0 × 42.0                       | 17.0                 | 4.5                    | B32656S7125+562                             | T2            | 48              |     |     |
|       |                                   | 1200  | 30.0 × 45.0 × 42.0                       | 17.0                 | 4.5                    | B32656S7125+563                             | T3            | 96              |     |     |
|       |                                   | 1200  | 30.0 × 45.0 × 42.0                       | 17.0                 | 4.5                    | B32656S7125+566                             | T6            | 48              |     |     |
|       |                                   | 1200  | 30.0 × 45.0 × 42.0                       | 17.0                 | 4.5                    | B32656S7125+577                             | T7            | 96              |     |     |
|       |                                   | 1500  | 30.0 × 45.0 × 42.0                       | 19.0                 | 4.0                    | B32656S7155+408                             | T8            | 48              |     |     |
|       |                                   | 1500  | 30.0 × 45.0 × 42.0                       | 19.0                 | 4.0                    | B32656S7155+409                             | T9            | 48              |     |     |
|       |                                   | 1500  | 30.0 × 45.0 × 42.0                       | 19.0                 | 4.0                    | B32656S7155+410                             | T10           | 80              |     |     |
|       |                                   | 1500  | 30.0 × 45.0 × 42.0                       | 19.0                 | 4.0                    | B32656S7155+411                             | T11           | 64              |     |     |
|       |                                   | 1500  | 30.0 × 45.0 × 42.0                       | 19.0                 | 4.0                    | B32656S7155+418                             | T18           | 48              |     |     |
|       |                                   | 1500  | 30.0 × 45.0 × 42.0                       | 19.0                 | 4.0                    | B32656S7155+561                             | T1            | 48              |     |     |
|       |                                   | 1500  | 30.0 × 45.0 × 42.0                       | 19.0                 | 4.0                    | B32656S7155+562                             | T2            | 48              |     |     |
|       |                                   | 1500  | 30.0 × 45.0 × 42.0                       | 19.0                 | 4.0                    | B32656S7155+563                             | T3            | 96              |     |     |
|       |                                   | 1500  | 30.0 × 45.0 × 42.0                       | 19.0                 | 4.0                    | B32656S7155+566                             | T6            | 48              |     |     |
|       |                                   | 1500  | 30.0 × 45.0 × 42.0                       | 19.0                 | 4.0                    | B32656S7155+577                             | T7            | 96              |     |     |
|       |                                   | 1800  | 33.0 × 48.0 × 43.0                       | 22.0                 | 3.5                    | B32656S7185+408                             | T8            | 84              |     |     |
|       |                                   | 1800  | 33.0 × 48.0 × 43.0                       | 22.0                 | 3.5                    | B32656S7185+409                             | T9            | 84              |     |     |
|       |                                   | 1800  | 33.0 × 48.0 × 43.0                       | 22.0                 | 3.5                    | B32656S7185+410                             | T10           | 60              |     |     |
|       |                                   | 1800  | 33.0 × 48.0 × 43.0                       | 22.0                 | 3.5                    | B32656S7185+411                             | T11           | 56              |     |     |
|       |                                   | 1800  | 33.0 × 48.0 × 43.0                       | 22.0                 | 3.5                    | B32656S7185+418                             | T18           | 84              |     |     |
|       |                                   | 1800  | 33.0 × 48.0 × 43.0                       | 22.0                 | 3.5                    | B32656S7185+561                             | T1            | 84              |     |     |
|       |                                   | 1800  | 33.0 × 48.0 × 43.0                       | 22.0                 | 3.5                    | B32656S7185+562                             | T2            | 84              |     |     |
|       |                                   | 1800  | 33.0 × 48.0 × 43.0                       | 22.0                 | 3.5                    | B32656S7185+563                             | T3            | 64              |     |     |
|       |                                   | 1800  | 33.0 × 48.0 × 43.0                       | 22.0                 | 3.5                    | B32656S7185+566                             | T6            | 84              |     |     |
|       |                                   | 1800  | 33.0 × 48.0 × 43.0                       | 22.0                 | 3.5                    | B32656S7185+577                             | T7            | 84              |     |     |
|       |                                   | 1700  | 750                                      | 120                  | 14.0 × 25.0 × 42.0     | 6.5   | 14.0          | B32656S1124+408 | T8  | 288 |
|       |                                   |       |  | 120                  | 14.0 × 25.0 × 42.0     | 6.5   | 14.0          | B32656S1124+418 | T18 | 288 |
|       |                                   |       |  | 120                  | 14.0 × 25.0 × 42.0     | 6.5   | 14.0          | B32656S1124+563 | T3  | 168 |
| 120   | 14.0 × 25.0 × 42.0                |       |  | 6.5                  | 14.0                   | B32656S1124+564                             | T4            | 288             |     |     |
| 120   | 14.0 × 25.0 × 42.0                |       |  | 6.5                  | 14.0                   | B32656S1124+565                             | T5            | 288             |     |     |

MOQ = Minimum Order Quantity, consisting of 4 packing units.  
Further E series and intermediate capacitance values on request.

**Composition of ordering code**

+ = Capacitance tolerance code:

K = ±10%

J = ±5%

**Electrical specifications, ordering codes and packing units**

| $V_R$ | $V_{RMS}$<br>$f \leq 1\text{kHz}$ | $C_R$              | Max. dimensions<br>$w \times h \times l$<br>mm | $I_{RMS}$<br>100 kHz<br>A | ESR <sub>typ</sub><br>100 kHz<br>mΩ | Ordering code<br>(composition see<br>below) | Ter-<br>minal | pcs./<br>MOQ |
|-------|-----------------------------------|--------------------|--|---------------------------|-------------------------------------|---|---------------|--------------|
| V DC  | V AC                              | nF                 |  |                           |                                     |   |               |              |
| 1700  | 750                               | 150                | 14.0 × 25.0 × 42.0                             | 7.0                       | 13.0                                | B32656S1154+408                             | T8            | 288          |
|       |                                   | 150                | 14.0 × 25.0 × 42.0                             | 7.0                       | 13.0                                | B32656S1154+418                             | T18           | 288          |
|       |                                   | 150                | 14.0 × 25.0 × 42.0                             | 7.0                       | 13.0                                | B32656S1154+563                             | T3            | 168          |
|       |                                   | 150                | 14.0 × 25.0 × 42.0                             | 7.0                       | 13.0                                | B32656S1154+564                             | T4            | 288          |
|       |                                   | 150                | 14.0 × 25.0 × 42.0                             | 7.0                       | 13.0                                | B32656S1154+565                             | T5            | 288          |
|       |                                   | 220                | 16.0 × 28.5 × 42.0                             | 8.5                       | 10.5                                | B32656S1224+408                             | T8            | 192          |
|       |                                   | 220                | 16.0 × 28.5 × 42.0                             | 8.5                       | 10.5                                | B32656S1224+409                             | T9            | 192          |
|       |                                   | 220                | 16.0 × 28.5 × 42.0                             | 8.5                       | 10.5                                | B32656S1224+411                             | T11           | 128          |
|       |                                   | 220                | 16.0 × 28.5 × 42.0                             | 8.5                       | 10.5                                | B32656S1224+418                             | T18           | 192          |
|       |                                   | 220                | 16.0 × 28.5 × 42.0                             | 8.5                       | 10.5                                | B32656S1224+561                             | T1            | 192          |
|       |                                   | 220                | 16.0 × 28.5 × 42.0                             | 8.5                       | 10.5                                | B32656S1224+562                             | T2            | 192          |
|       |                                   | 220                | 16.0 × 28.5 × 42.0                             | 8.5                       | 10.5                                | B32656S1224+563                             | T3            | 144          |
|       |                                   | 220                | 16.0 × 28.5 × 42.0                             | 8.5                       | 10.5                                | B32656S1224+564                             | T4            | 192          |
|       |                                   | 220                | 16.0 × 28.5 × 42.0                             | 8.5                       | 10.5                                | B32656S1224+565                             | T5            | 192          |
|       |                                   | 220                | 16.0 × 28.5 × 42.0                             | 8.5                       | 10.5                                | B32656S1224+566                             | T6            | 192          |
|       | 220                               | 16.0 × 28.5 × 42.0 | 8.5  | 10.5                      | B32656S1224+577                     | T7  | 180           |              |
|       | 270                               | 18.0 × 32.5 × 42.0 | 9.5  | 9.0                       | B32656S1274+408                     | T8  | 140           |              |
|       | 270                               | 18.0 × 32.5 × 42.0 | 9.5  | 9.0                       | B32656S1274+409                     | T9  | 140           |              |
|       | 270                               | 18.0 × 32.5 × 42.0 | 9.5  | 9.0                       | B32656S1274+411                     | T11   | 112           |              |
|       | 270                               | 18.0 × 32.5 × 42.0 | 9.5  | 9.0                       | B32656S1274+418                     | T18   | 140           |              |
|       | 270                               | 18.0 × 32.5 × 42.0 | 9.5  | 9.0                       | B32656S1274+561                     | T1  | 140           |              |
|       | 270                               | 18.0 × 32.5 × 42.0 | 9.5  | 9.0                       | B32656S1274+562                     | T2  | 140           |              |
|       | 270                               | 18.0 × 32.5 × 42.0 | 9.5  | 9.0                       | B32656S1274+563                     | T3  | 120           |              |
|       | 270                               | 18.0 × 32.5 × 42.0 | 9.5  | 9.0                       | B32656S1274+564                     | T4  | 128           |              |
|       | 270                               | 18.0 × 32.5 × 42.0 | 9.5  | 9.0                       | B32656S1274+565                     | T5  | 128           |              |
|       | 270                               | 18.0 × 32.5 × 42.0 | 9.5  | 9.0                       | B32656S1274+566                     | T6  | 140           |              |
|       | 270                               | 18.0 × 32.5 × 42.0 | 9.5  | 9.0                       | B32656S1274+577                     | T7  | 156           |              |

MOQ = Minimum Order Quantity, consisting of 4 packing units.  
Further E series and intermediate capacitance values on request.

**Composition of ordering code**

+ = Capacitance tolerance code:

K = ±10%

J = ±5%

**B32656S**
**Snubber (wound)**
**Electrical specifications, ordering codes and packing units**

| $V_R$ | $V_{RMS}$<br>$f \leq 1 \text{ kHz}$ | $C_R$ | Max. dimensions<br>$w \times h \times l$<br>mm | $I_{RMS}$<br>100 kHz<br>A | ESR <sub>typ</sub><br>100 kHz<br>mΩ | Ordering code<br>(composition see<br>below) | Ter-<br>minal | pcs./<br>MOQ |
|-------|-------------------------------------|-------|--|---------------------------|-------------------------------------|---|---------------|--------------|
| V DC  | V AC                                | nF    |  |                           |                                     |   |               |              |
| 1700  | 750                                 | 330   | 20.0 × 39.5 × 42.0                             | 12.0                      | 8.0                                 | B32656S1334+408                             | T8            | 96           |
|       |                                     | 330   | 20.0 × 39.5 × 42.0                             | 12.0                      | 8.0                                 | B32656S1334+409                             | T9            | 96           |
|       |                                     | 330   | 20.0 × 39.5 × 42.0                             | 12.0                      | 8.0                                 | B32656S1334+410                             | T10           | 120          |
|       |                                     | 330   | 20.0 × 39.5 × 42.0                             | 12.0                      | 8.0                                 | B32656S1334+411                             | T11           | 96           |
|       |                                     | 330   | 20.0 × 39.5 × 42.0                             | 12.0                      | 8.0                                 | B32656S1334+418                             | T18           | 96           |
|       |                                     | 330   | 20.0 × 39.5 × 42.0                             | 12.0                      | 8.0                                 | B32656S1334+561                             | T1            | 96           |
|       |                                     | 330   | 20.0 × 39.5 × 42.0                             | 12.0                      | 8.0                                 | B32656S1334+562                             | T2            | 96           |
|       |                                     | 330   | 20.0 × 39.5 × 42.0                             | 12.0                      | 8.0                                 | B32656S1334+563                             | T3            | 104          |
|       |                                     | 330   | 20.0 × 39.5 × 42.0                             | 12.0                      | 8.0                                 | B32656S1334+564                             | T4            | 96           |
|       |                                     | 330   | 20.0 × 39.5 × 42.0                             | 12.0                      | 8.0                                 | B32656S1334+565                             | T5            | 96           |
|       |                                     | 330   | 20.0 × 39.5 × 42.0                             | 12.0                      | 8.0                                 | B32656S1334+566                             | T6            | 96           |
|       |                                     | 330   | 20.0 × 39.5 × 42.0                             | 12.0                      | 8.0                                 | B32656S1334+577                             | T7            | 144          |
|       |                                     | 390   | 28.0 × 37.0 × 42.0                             | 13.5                      | 7.0                                 | B32656S1394+408                             | T8            | 108          |
|       |                                     | 390   | 28.0 × 37.0 × 42.0                             | 13.5                      | 7.0                                 | B32656S1394+409                             | T9            | 108          |
|       |                                     | 390   | 28.0 × 37.0 × 42.0                             | 13.5                      | 7.0                                 | B32656S1394+410                             | T10           | 80           |
|       |                                     | 390   | 28.0 × 37.0 × 42.0                             | 13.5                      | 7.0                                 | B32656S1394+411                             | T11           | 72           |
|       |                                     | 390   | 28.0 × 37.0 × 42.0                             | 13.5                      | 7.0                                 | B32656S1394+418                             | T18           | 108          |
|       |                                     | 390   | 28.0 × 37.0 × 42.0                             | 13.5                      | 7.0                                 | B32656S1394+561                             | T1            | 108          |
|       |                                     | 390   | 28.0 × 37.0 × 42.0                             | 13.5                      | 7.0                                 | B32656S1394+562                             | T2            | 108          |
|       |                                     | 390   | 28.0 × 37.0 × 42.0                             | 13.5                      | 7.0                                 | B32656S1394+563                             | T3            | 96           |
|       |                                     | 390   | 28.0 × 37.0 × 42.0                             | 13.5                      | 7.0                                 | B32656S1394+566                             | T6            | 108          |
|       |                                     | 390   | 28.0 × 37.0 × 42.0                             | 13.5                      | 7.0                                 | B32656S1394+577                             | T7            | 96           |
|       |                                     | 470   | 28.0 × 37.0 × 42.0                             | 14.5                      | 6.0                                 | B32656S1474+408                             | T8            | 108          |
|       |                                     | 470   | 28.0 × 37.0 × 42.0                             | 14.5                      | 6.0                                 | B32656S1474+409                             | T9            | 108          |
|       |                                     | 470   | 28.0 × 37.0 × 42.0                             | 14.5                      | 6.0                                 | B32656S1474+410                             | T10           | 72           |
|       |                                     | 470   | 28.0 × 37.0 × 42.0                             | 14.5                      | 6.0                                 | B32656S1474+411                             | T11           | 108          |
|       |                                     | 470   | 28.0 × 37.0 × 42.0                             | 14.5                      | 6.0                                 | B32656S1474+418                             | T18           | 108          |
|       |                                     | 470   | 28.0 × 37.0 × 42.0                             | 14.5                      | 6.0                                 | B32656S1474+561                             | T1            | 108          |
|       |                                     | 470   | 28.0 × 37.0 × 42.0                             | 14.5                      | 6.0                                 | B32656S1474+562                             | T2            | 108          |
|       |                                     | 470   | 28.0 × 37.0 × 42.0                             | 14.5                      | 6.0                                 | B32656S1474+563                             | T3            | 96           |
|       |                                     | 470   | 28.0 × 37.0 × 42.0                             | 14.5                      | 6.0                                 | B32656S1474+566                             | T6            | 108          |
|       |                                     | 470   | 28.0 × 37.0 × 42.0                             | 14.5                      | 6.0                                 | B32656S1474+577                             | T7            | 96           |

MOQ = Minimum Order Quantity, consisting of 4 packing units.

Further E series and intermediate capacitance values on request.

**Composition of ordering code**

+ = Capacitance tolerance code:

K = ±10%

J = ±5%

**Electrical specifications, ordering codes and packing units**

| $V_R$ | $V_{RMS}$<br>$f \leq 1 \text{ kHz}$ | $C_R$ | Max. dimensions<br>$w \times h \times l$<br>mm | $I_{RMS}$<br>100 kHz<br>A | ESR <sub>typ</sub><br>100 kHz<br>mΩ | Ordering code<br>(composition see<br>below) | Ter-<br>minal | pcs./<br>MOQ |
|-------|-------------------------------------|-------|--|---------------------------|-------------------------------------|---|---------------|--------------|
| V DC  | V AC                                | nF    |  |                           |                                     |   |               |              |
| 1700  | 750                                 | 560   | 30.0 × 45.0 × 42.0                             | 16.5                      | 5.5                                 | B32656S1564+408                             | T8            | 48           |
|       |                                     | 560   | 30.0 × 45.0 × 42.0                             | 16.5                      | 5.5                                 | B32656S1564+409                             | T9            | 48           |
|       |                                     | 560   | 30.0 × 45.0 × 42.0                             | 16.5                      | 5.5                                 | B32656S1564+410                             | T10           | 80           |
|       |                                     | 560   | 30.0 × 45.0 × 42.0                             | 16.5                      | 5.5                                 | B32656S1564+411                             | T11           | 64           |
|       |                                     | 560   | 30.0 × 45.0 × 42.0                             | 16.5                      | 5.5                                 | B32656S1564+418                             | T18           | 48           |
|       |                                     | 560   | 30.0 × 45.0 × 42.0                             | 16.5                      | 5.5                                 | B32656S1564+561                             | T1            | 48           |
|       |                                     | 560   | 30.0 × 45.0 × 42.0                             | 16.5                      | 5.5                                 | B32656S1564+562                             | T2            | 48           |
|       |                                     | 560   | 30.0 × 45.0 × 42.0                             | 16.5                      | 5.5                                 | B32656S1564+563                             | T3            | 96           |
|       |                                     | 560   | 30.0 × 45.0 × 42.0                             | 16.5                      | 5.5                                 | B32656S1564+566                             | T6            | 48           |
|       |                                     | 560   | 30.0 × 45.0 × 42.0                             | 16.5                      | 5.5                                 | B32656S1564+577                             | T7            | 96           |
|       |                                     | 680   | 30.0 × 45.0 × 42.0                             | 18.0                      | 5.0                                 | B32656S1684+408                             | T8            | 48           |
|       |                                     | 680   | 30.0 × 45.0 × 42.0                             | 18.0                      | 5.0                                 | B32656S1684+409                             | T9            | 48           |
|       |                                     | 680   | 30.0 × 45.0 × 42.0                             | 18.0                      | 5.0                                 | B32656S1684+410                             | T10           | 80           |
|       |                                     | 680   | 30.0 × 45.0 × 42.0                             | 18.0                      | 5.0                                 | B32656S1684+411                             | T11           | 64           |
|       |                                     | 680   | 30.0 × 45.0 × 42.0                             | 18.0                      | 5.0                                 | B32656S1684+418                             | T18           | 48           |
|       |                                     | 680   | 30.0 × 45.0 × 42.0                             | 18.0                      | 5.0                                 | B32656S1684+561                             | T1            | 48           |
|       |                                     | 680   | 30.0 × 45.0 × 42.0                             | 18.0                      | 5.0                                 | B32656S1684+562                             | T2            | 48           |
|       |                                     | 680   | 30.0 × 45.0 × 42.0                             | 18.0                      | 5.0                                 | B32656S1684+563                             | T3            | 96           |
|       |                                     | 680   | 30.0 × 45.0 × 42.0                             | 18.0                      | 5.0                                 | B32656S1684+566                             | T6            | 48           |
|       |                                     | 680   | 30.0 × 45.0 × 42.0                             | 18.0                      | 5.0                                 | B32656S1684+577                             | T7            | 96           |
|       |                                     | 820   | 33.0 × 48.0 × 43.0                             | 20.0                      | 4.0                                 | B32656S1824+408                             | T8            | 84           |
|       |                                     | 820   | 33.0 × 48.0 × 43.0                             | 20.0                      | 4.0                                 | B32656S1824+409                             | T9            | 84           |
|       |                                     | 820   | 33.0 × 48.0 × 43.0                             | 20.0                      | 4.0                                 | B32656S1824+410                             | T10           | 60           |
|       |                                     | 820   | 33.0 × 48.0 × 43.0                             | 20.0                      | 4.0                                 | B32656S1824+411                             | T11           | 56           |
|       |                                     | 820   | 33.0 × 48.0 × 43.0                             | 20.0                      | 4.0                                 | B32656S1824+418                             | T18           | 84           |
|       |                                     | 820   | 33.0 × 48.0 × 43.0                             | 20.0                      | 4.0                                 | B32656S1824+561                             | T1            | 84           |
|       |                                     | 820   | 33.0 × 48.0 × 43.0                             | 20.0                      | 4.0                                 | B32656S1824+562                             | T2            | 84           |
|       |                                     | 820   | 33.0 × 48.0 × 43.0                             | 20.0                      | 4.0                                 | B32656S1824+563                             | T3            | 64           |
|       |                                     | 820   | 33.0 × 48.0 × 43.0                             | 20.0                      | 4.0                                 | B32656S1824+566                             | T6            | 84           |
|       |                                     | 820   | 33.0 × 48.0 × 43.0                             | 20.0                      | 4.0                                 | B32656S1824+577                             | T7            | 84           |

MOQ = Minimum Order Quantity, consisting of 4 packing units.

Further E series and intermediate capacitance values on request.

**Composition of ordering code**

+ = Capacitance tolerance code:

K = ±10%

J = ±5%

**B32656S**
**Snubber (wound)**
**Electrical specifications, ordering codes and packing units**

| $V_R$ | $V_{RMS}$<br>$f \leq 1 \text{ kHz}$ | $C_R$ | Max. dimensions<br>$w \times h \times l$<br>mm | $I_{RMS}$<br>100 kHz<br>A | ESR <sub>typ</sub><br>100 kHz<br>mΩ | Ordering code<br>(composition see<br>below) | Ter-<br>minal | pcs./<br>MOQ |
|-------|-------------------------------------|-------|--|---------------------------|-------------------------------------|---|---------------|--------------|
| V DC  | V AC                                | nF    |  |                           |                                     |   |               |              |
| 2000  | 800                                 | 68    | 14.0 × 25.0 × 42.0                             | 6.0                       | 17.0                                | B32656S2683+408                             | T8            | 288          |
|       |                                     | 68    | 14.0 × 25.0 × 42.0                             | 6.0                       | 17.0                                | B32656S2683+418                             | T18           | 288          |
|       |                                     | 68    | 14.0 × 25.0 × 42.0                             | 6.0                       | 17.0                                | B32656S2683+563                             | T3            | 168          |
|       |                                     | 68    | 14.0 × 25.0 × 42.0                             | 6.0                       | 17.0                                | B32656S2683+564                             | T4            | 288          |
|       |                                     | 68    | 14.0 × 25.0 × 42.0                             | 6.0                       | 17.0                                | B32656S2683+565                             | T5            | 288          |
|       |                                     | 100   | 14.0 × 25.0 × 42.0                             | 6.5                       | 15.0                                | B32656S2104+408                             | T8            | 288          |
|       |                                     | 100   | 14.0 × 25.0 × 42.0                             | 6.5                       | 15.0                                | B32656S2104+418                             | T18           | 288          |
|       |                                     | 100   | 14.0 × 25.0 × 42.0                             | 6.5                       | 15.0                                | B32656S2104+563                             | T3            | 168          |
|       |                                     | 100   | 14.0 × 25.0 × 42.0                             | 6.5                       | 15.0                                | B32656S2104+564                             | T4            | 288          |
|       |                                     | 100   | 14.0 × 25.0 × 42.0                             | 6.5                       | 15.0                                | B32656S2104+565                             | T5            | 288          |
|       |                                     | 120   | 16.0 × 28.5 × 42.0                             | 7.0                       | 14.0                                | B32656S2124+408                             | T8            | 192          |
|       |                                     | 120   | 16.0 × 28.5 × 42.0                             | 7.0                       | 14.0                                | B32656S2124+409                             | T9            | 192          |
|       |                                     | 120   | 16.0 × 28.5 × 42.0                             | 7.0                       | 14.0                                | B32656S2124+411                             | T11           | 128          |
|       |                                     | 120   | 16.0 × 28.5 × 42.0                             | 7.0                       | 14.0                                | B32656S2124+418                             | T18           | 192          |
|       |                                     | 120   | 16.0 × 28.5 × 42.0                             | 7.0                       | 14.0                                | B32656S2124+561                             | T1            | 192          |
|       |                                     | 120   | 16.0 × 28.5 × 42.0                             | 7.0                       | 14.0                                | B32656S2124+562                             | T2            | 192          |
|       |                                     | 120   | 16.0 × 28.5 × 42.0                             | 7.0                       | 14.0                                | B32656S2124+563                             | T3            | 144          |
|       |                                     | 120   | 16.0 × 28.5 × 42.0                             | 7.0                       | 14.0                                | B32656S2124+564                             | T4            | 192          |
|       |                                     | 120   | 16.0 × 28.5 × 42.0                             | 7.0                       | 14.0                                | B32656S2124+565                             | T5            | 192          |
|       |                                     | 120   | 16.0 × 28.5 × 42.0                             | 7.0                       | 14.0                                | B32656S2124+566                             | T6            | 192          |
|       |                                     | 120   | 16.0 × 28.5 × 42.0                             | 7.0                       | 14.0                                | B32656S2124+577                             | T7            | 180          |
|       |                                     | 150   | 18.0 × 32.5 × 42.0                             | 8.0                       | 13.0                                | B32656S2154+408                             | T8            | 140          |
|       |                                     | 150   | 18.0 × 32.5 × 42.0                             | 8.0                       | 13.0                                | B32656S2154+409                             | T9            | 140          |
|       |                                     | 150   | 18.0 × 32.5 × 42.0                             | 8.0                       | 13.0                                | B32656S2154+411                             | T11           | 112          |
|       |                                     | 150   | 18.0 × 32.5 × 42.0                             | 8.0                       | 13.0                                | B32656S2154+418                             | T18           | 140          |
|       |                                     | 150   | 18.0 × 32.5 × 42.0                             | 8.0                       | 13.0                                | B32656S2154+561                             | T1            | 140          |
|       |                                     | 150   | 18.0 × 32.5 × 42.0                             | 8.0                       | 13.0                                | B32656S2154+562                             | T2            | 140          |
|       |                                     | 150   | 18.0 × 32.5 × 42.0                             | 8.0                       | 13.0                                | B32656S2154+563                             | T3            | 120          |
|       |                                     | 150   | 18.0 × 32.5 × 42.0                             | 8.0                       | 13.0                                | B32656S2154+564                             | T4            | 128          |
|       |                                     | 150   | 18.0 × 32.5 × 42.0                             | 8.0                       | 13.0                                | B32656S2154+565                             | T5            | 128          |
|       |                                     | 150   | 18.0 × 32.5 × 42.0                             | 8.0                       | 13.0                                | B32656S2154+566                             | T6            | 140          |
|       |                                     | 150   | 18.0 × 32.5 × 42.0                             | 8.0                       | 13.0                                | B32656S2154+577                             | T7            | 156          |

MOQ = Minimum Order Quantity, consisting of 4 packing units.

Further E series and intermediate capacitance values on request.

**Composition of ordering code**

+ = Capacitance tolerance code:

K = ±10%

J = ±5%



**B32656S**
**Snubber (wound)**

  
MKP

**Electrical specifications, ordering codes and packing units**

| $V_R$ | $V_{RMS}$<br>$f \leq 1\text{kHz}$ | $C_R$ | Max. dimensions<br>$w \times h \times l$<br>mm | $I_{RMS}$<br>100 kHz<br>A | ESR <sub>typ</sub><br>100 kHz<br>mΩ | Ordering code<br>(composition see<br>below) | Ter-<br>minal | pcs./<br>MOQ |
|-------|-----------------------------------|-------|--|---------------------------|-------------------------------------|---|---------------|--------------|
| V DC  | V AC                              | nF    |  |                           |                                     |   |               |              |
| 2000  | 800                               | 220   | 20.0 × 39.5 × 42.0                             | 11.0                      | 9.0                                 | B32656S2224+408                             | T8            | 96           |
|       |                                   | 220   | 20.0 × 39.5 × 42.0                             | 11.0                      | 9.0                                 | B32656S2224+409                             | T9            | 96           |
|       |                                   | 220   | 20.0 × 39.5 × 42.0                             | 11.0                      | 9.0                                 | B32656S2224+410                             | T10           | 120          |
|       |                                   | 220   | 20.0 × 39.5 × 42.0                             | 11.0                      | 9.0                                 | B32656S2224+411                             | T11           | 96           |
|       |                                   | 220   | 20.0 × 39.5 × 42.0                             | 11.0                      | 9.0                                 | B32656S2224+418                             | T18           | 96           |
|       |                                   | 220   | 20.0 × 39.5 × 42.0                             | 11.0                      | 9.0                                 | B32656S2224+561                             | T1            | 96           |
|       |                                   | 220   | 20.0 × 39.5 × 42.0                             | 11.0                      | 9.0                                 | B32656S2224+562                             | T2            | 96           |
|       |                                   | 220   | 20.0 × 39.5 × 42.0                             | 11.0                      | 9.0                                 | B32656S2224+563                             | T3            | 104          |
|       |                                   | 220   | 20.0 × 39.5 × 42.0                             | 11.0                      | 9.0                                 | B32656S2224+564                             | T4            | 96           |
|       |                                   | 220   | 20.0 × 39.5 × 42.0                             | 11.0                      | 9.0                                 | B32656S2224+565                             | T5            | 96           |
|       |                                   | 220   | 20.0 × 39.5 × 42.0                             | 11.0                      | 9.0                                 | B32656S2224+566                             | T6            | 96           |
|       |                                   | 220   | 20.0 × 39.5 × 42.0                             | 11.0                      | 9.0                                 | B32656S2224+577                             | T7            | 144          |
|       |                                   | 270   | 28.0 × 37.0 × 42.0                             | 12.5                      | 8.0                                 | B32656S2274+408                             | T8            | 108          |
|       |                                   | 270   | 28.0 × 37.0 × 42.0                             | 12.5                      | 8.0                                 | B32656S2274+409                             | T9            | 108          |
|       |                                   | 270   | 28.0 × 37.0 × 42.0                             | 12.5                      | 8.0                                 | B32656S2274+410                             | T10           | 80           |
|       |                                   | 270   | 28.0 × 37.0 × 42.0                             | 12.5                      | 8.0                                 | B32656S2274+411                             | T11           | 72           |
|       |                                   | 270   | 28.0 × 37.0 × 42.0                             | 12.5                      | 8.0                                 | B32656S2274+418                             | T18           | 108          |
|       |                                   | 270   | 28.0 × 37.0 × 42.0                             | 12.5                      | 8.0                                 | B32656S2274+561                             | T1            | 108          |
|       |                                   | 270   | 28.0 × 37.0 × 42.0                             | 12.5                      | 8.0                                 | B32656S2274+562                             | T2            | 108          |
|       |                                   | 270   | 28.0 × 37.0 × 42.0                             | 12.5                      | 8.0                                 | B32656S2274+563                             | T3            | 96           |
|       |                                   | 270   | 28.0 × 37.0 × 42.0                             | 12.5                      | 8.0                                 | B32656S2274+566                             | T6            | 108          |
|       |                                   | 270   | 28.0 × 37.0 × 42.0                             | 12.5                      | 8.0                                 | B32656S2274+577                             | T7            | 96           |
|       |                                   | 330   | 28.0 × 37.0 × 42.0                             | 14.0                      | 6.5                                 | B32656S2334+408                             | T8            | 108          |
|       |                                   | 330   | 28.0 × 37.0 × 42.0                             | 14.0                      | 6.5                                 | B32656S2334+409                             | T9            | 108          |
|       |                                   | 330   | 28.0 × 37.0 × 42.0                             | 14.0                      | 6.5                                 | B32656S2334+410                             | T10           | 80           |
|       |                                   | 330   | 28.0 × 37.0 × 42.0                             | 14.0                      | 6.5                                 | B32656S2334+411                             | T11           | 72           |
|       |                                   | 330   | 28.0 × 37.0 × 42.0                             | 14.0                      | 6.5                                 | B32656S2334+418                             | T18           | 108          |
|       |                                   | 330   | 28.0 × 37.0 × 42.0                             | 14.0                      | 6.5                                 | B32656S2334+561                             | T1            | 108          |
|       |                                   | 330   | 28.0 × 37.0 × 42.0                             | 14.0                      | 6.5                                 | B32656S2334+562                             | T2            | 108          |
|       |                                   | 330   | 28.0 × 37.0 × 42.0                             | 14.0                      | 6.5                                 | B32656S2334+563                             | T3            | 96           |
|       |                                   | 330   | 28.0 × 37.0 × 42.0                             | 14.0                      | 6.5                                 | B32656S2334+566                             | T6            | 108          |
|       |                                   | 330   | 28.0 × 37.0 × 42.0                             | 14.0                      | 6.5                                 | B32656S2334+577                             | T7            | 96           |

MOQ = Minimum Order Quantity, consisting of 4 packing units.

Further E series and intermediate capacitance values on request.

**Composition of ordering code**

+ = Capacitance tolerance code:

K = ±10%

J = ±5%

**B32656S**
**Snubber (wound)**
**Electrical specifications, ordering codes and packing units**

| $V_R$ | $V_{RMS}$<br>$f \leq 1 \text{ kHz}$ | $C_R$ | Max. dimensions<br>$w \times h \times l$<br>mm | $I_{RMS}$<br>100 kHz<br>A | $ESR_{typ}$<br>100 kHz<br>m $\Omega$ | Ordering code<br>(composition see<br>below) | Ter-<br>minal | pcs./<br>MOQ |
|-------|-------------------------------------|-------|--|---------------------------|--------------------------------------|---|---------------|--------------|
| V DC  | V AC                                | nF    |  |                           |                                      |   |               |              |
| 2000  | 800                                 | 390   | 30.0 × 45.0 × 42.0                             | 15.0                      | 6.5                                  | B32656S2394+408                             | T8            | 48           |
|       |                                     | 390   | 30.0 × 45.0 × 42.0                             | 15.0                      | 6.5                                  | B32656S2394+409                             | T9            | 48           |
|       |                                     | 390   | 30.0 × 45.0 × 42.0                             | 15.0                      | 6.5                                  | B32656S2394+410                             | T10           | 80           |
|       |                                     | 390   | 30.0 × 45.0 × 42.0                             | 15.0                      | 6.5                                  | B32656S2394+411                             | T11           | 64           |
|       |                                     | 390   | 30.0 × 45.0 × 42.0                             | 15.0                      | 6.5                                  | B32656S2394+418                             | T18           | 48           |
|       |                                     | 390   | 30.0 × 45.0 × 42.0                             | 15.0                      | 6.5                                  | B32656S2394+561                             | T1            | 48           |
|       |                                     | 390   | 30.0 × 45.0 × 42.0                             | 15.0                      | 6.5                                  | B32656S2394+562                             | T2            | 48           |
|       |                                     | 390   | 30.0 × 45.0 × 42.0                             | 15.0                      | 6.5                                  | B32656S2394+563                             | T3            | 96           |
|       |                                     | 390   | 30.0 × 45.0 × 42.0                             | 15.0                      | 6.5                                  | B32656S2394+566                             | T6            | 48           |
|       |                                     | 390   | 30.0 × 45.0 × 42.0                             | 15.0                      | 6.5                                  | B32656S2394+577                             | T7            | 96           |
|       |                                     | 470   | 30.0 × 45.0 × 42.0                             | 17.0                      | 5.5                                  | B32656S2474+408                             | T8            | 48           |
|       |                                     | 470   | 30.0 × 45.0 × 42.0                             | 17.0                      | 5.5                                  | B32656S2474+409                             | T9            | 48           |
|       |                                     | 470   | 30.0 × 45.0 × 42.0                             | 17.0                      | 5.5                                  | B32656S2474+410                             | T10           | 80           |
|       |                                     | 470   | 30.0 × 45.0 × 42.0                             | 17.0                      | 5.5                                  | B32656S2474+411                             | T11           | 64           |
|       |                                     | 470   | 30.0 × 45.0 × 42.0                             | 17.0                      | 5.5                                  | B32656S2474+418                             | T18           | 48           |
|       |                                     | 470   | 30.0 × 45.0 × 42.0                             | 17.0                      | 5.5                                  | B32656S2474+561                             | T1            | 48           |
|       |                                     | 470   | 30.0 × 45.0 × 42.0                             | 17.0                      | 5.5                                  | B32656S2474+562                             | T2            | 48           |
|       |                                     | 470   | 30.0 × 45.0 × 42.0                             | 17.0                      | 5.5                                  | B32656S2474+563                             | T3            | 96           |
|       |                                     | 470   | 30.0 × 45.0 × 42.0                             | 17.0                      | 5.5                                  | B32656S2474+566                             | T6            | 48           |
|       |                                     | 470   | 30.0 × 45.0 × 42.0                             | 17.0                      | 5.5                                  | B32656S2474+577                             | T7            | 96           |
|       |                                     | 560   | 33.0 × 48.0 × 43.0                             | 19.0                      | 4.5                                  | B32656S2564+408                             | T8            | 84           |
|       |                                     | 560   | 33.0 × 48.0 × 43.0                             | 19.0                      | 4.5                                  | B32656S2564+409                             | T9            | 84           |
|       |                                     | 560   | 33.0 × 48.0 × 43.0                             | 19.0                      | 4.5                                  | B32656S2564+410                             | T10           | 60           |
|       |                                     | 560   | 33.0 × 48.0 × 43.0                             | 19.0                      | 4.5                                  | B32656S2564+411                             | T11           | 56           |
|       |                                     | 560   | 33.0 × 48.0 × 43.0                             | 19.0                      | 4.5                                  | B32656S2564+418                             | T18           | 84           |
|       |                                     | 560   | 33.0 × 48.0 × 43.0                             | 19.0                      | 4.5                                  | B32656S2564+561                             | T1            | 84           |
|       |                                     | 560   | 33.0 × 48.0 × 43.0                             | 19.0                      | 4.5                                  | B32656S2564+562                             | T2            | 84           |
|       |                                     | 560   | 33.0 × 48.0 × 43.0                             | 19.0                      | 4.5                                  | B32656S2564+563                             | T3            | 64           |
|       |                                     | 560   | 33.0 × 48.0 × 43.0                             | 19.0                      | 4.5                                  | B32656S2564+566                             | T6            | 84           |
|       |                                     | 560   | 33.0 × 48.0 × 43.0                             | 19.0                      | 4.5                                  | B32656S2564+577                             | T7            | 84           |

MOQ = Minimum Order Quantity, consisting of 4 packing units.

Further E series and intermediate capacitance values on request.

**Composition of ordering code**

+ = Capacitance tolerance code:

K = ±10%

J = ±5%

**B32658S**
**Snubber (wound)**

**Electrical specifications, ordering codes and packing units**

| $V_R$ | $V_{RMS}$<br>$f \leq 1 \text{ kHz}$ | $C_R$ | Max. dimensions<br>$w \times h \times l$<br>mm | $I_{RMS}$<br>100 kHz<br>A | $ESR_{typ}$<br>100 kHz<br>m $\Omega$ | Ordering code<br>(composition see<br>below) | Ter-<br>minal | pcs./<br>MOQ |
|-------|-------------------------------------|-------|--|---------------------------|--------------------------------------|---|---------------|--------------|
| V DC  | V AC                                | nF    |  |                           |                                      |   |               |              |
| 850   | 450                                 | 1500  | 22.5 × 33.0 × 57.5                             | 12.0                      | 7.0                                  | B32658S8155+414                             | T14           | 88           |
|       |                                     | 1500  | 22.5 × 33.0 × 57.5                             | 12.0                      | 7.0                                  | B32658S8155+416                             | T16           | 88           |
|       |                                     | 1800  | 22.5 × 33.0 × 57.5                             | 13.0                      | 6.5                                  | B32658S8185+414                             | T14           | 88           |
|       |                                     | 1800  | 22.5 × 33.0 × 57.5                             | 13.0                      | 6.5                                  | B32658S8185+416                             | T16           | 88           |
|       |                                     | 2200  | 22.5 × 33.0 × 57.5                             | 14.5                      | 5.5                                  | B32658S8225+414                             | T14           | 88           |
|       |                                     | 2200  | 22.5 × 33.0 × 57.5                             | 14.5                      | 5.5                                  | B32658S8225+416                             | T16           | 88           |
|       |                                     | 2700  | 27.0 × 39.5 × 57.5                             | 18.0                      | 5.0                                  | B32658S8275+414                             | T14           | 72           |
|       |                                     | 2700  | 27.0 × 39.5 × 57.5                             | 18.0                      | 5.0                                  | B32658S8275+415                             | T15           | 72           |
|       |                                     | 2700  | 27.0 × 39.5 × 57.5                             | 18.0                      | 5.0                                  | B32658S8275+416                             | T16           | 72           |
|       |                                     | 2700  | 27.0 × 39.5 × 57.5                             | 18.0                      | 5.0                                  | B32658S8275+417                             | T17           | 72           |
|       |                                     | 3000  | 27.0 × 39.5 × 57.5                             | 19.0                      | 4.5                                  | B32658S8305+414                             | T14           | 72           |
|       |                                     | 3000  | 27.0 × 39.5 × 57.5                             | 19.0                      | 4.5                                  | B32658S8305+415                             | T15           | 72           |
|       |                                     | 3000  | 27.0 × 39.5 × 57.5                             | 19.0                      | 4.5                                  | B32658S8305+416                             | T16           | 72           |
|       |                                     | 3000  | 27.0 × 39.5 × 57.5                             | 19.0                      | 4.5                                  | B32658S8305+417                             | T17           | 72           |
|       |                                     | 3300  | 27.0 × 39.5 × 57.5                             | 19.0                      | 4.5                                  | B32658S8335K414                             | T14           | 72           |
|       |                                     | 3300  | 27.0 × 39.5 × 57.5                             | 19.0                      | 4.5                                  | B32658S8335K415                             | T15           | 72           |
|       |                                     | 3300  | 27.0 × 39.5 × 57.5                             | 19.0                      | 4.5                                  | B32658S8335K416                             | T16           | 72           |
|       |                                     | 3300  | 27.0 × 39.5 × 57.5                             | 19.0                      | 4.5                                  | B32658S8335K417                             | T17           | 72           |
|       |                                     | 4000  | 30.0 × 45.0 × 57.5                             | 21.0                      | 4.0                                  | B32658S8405+414                             | T14           | 64           |
|       |                                     | 4000  | 30.0 × 45.0 × 57.5                             | 21.0                      | 4.0                                  | B32658S8405+415                             | T15           | 64           |
|       |                                     | 4000  | 30.0 × 45.0 × 57.5                             | 21.0                      | 4.0                                  | B32658S8405+416                             | T16           | 64           |
|       |                                     | 4000  | 30.0 × 45.0 × 57.5                             | 21.0                      | 4.0                                  | B32658S8405+417                             | T17           | 64           |
|       |                                     | 4500  | 30.0 × 45.0 × 57.5                             | 22.0                      | 3.7                                  | B32658S8455+414                             | T14           | 64           |
|       |                                     | 4500  | 30.0 × 45.0 × 57.5                             | 22.0                      | 3.7                                  | B32658S8455+415                             | T15           | 64           |
|       |                                     | 4500  | 30.0 × 45.0 × 57.5                             | 22.0                      | 3.7                                  | B32658S8455+416                             | T16           | 64           |
|       |                                     | 4500  | 30.0 × 45.0 × 57.5                             | 22.0                      | 3.7                                  | B32658S8455+417                             | T17           | 64           |
|       |                                     | 4700  | 35.0 × 50.0 × 57.5                             | 23.0                      | 3.5                                  | B32658S8475+414                             | T14           | 56           |
|       |                                     | 4700  | 35.0 × 50.0 × 57.5                             | 23.0                      | 3.5                                  | B32658S8475+415                             | T15           | 56           |
|       |                                     | 4700  | 35.0 × 50.0 × 57.5                             | 23.0                      | 3.5                                  | B32658S8475+416                             | T16           | 56           |
|       |                                     | 4700  | 35.0 × 50.0 × 57.5                             | 23.0                      | 3.5                                  | B32658S8475+417                             | T17           | 56           |

MOQ = Minimum Order Quantity, consisting of 4 packing units.  
Further E series and intermediate capacitance values on request.

**Composition of ordering code**

+ = Capacitance tolerance code:

K = ±10%

J = ±5%

**B32658S**
**Snubber (wound)**
**Electrical specifications, ordering codes and packing units**

| $V_R$ | $V_{RMS}$<br>$f \leq 1 \text{ kHz}$ | $C_R$ | Max. dimensions<br>$w \times h \times l$<br>mm | $I_{RMS}$<br>100 kHz<br>A | $ESR_{typ}$<br>100 kHz<br>m $\Omega$ | Ordering code<br>(composition see<br>below) | Ter-<br>minal | pcs./<br>MOQ |
|-------|-------------------------------------|-------|--|---------------------------|--------------------------------------|---|---------------|--------------|
| V DC  | V AC                                | nF    |  |                           |                                      |   |               |              |
| 850   | 450                                 | 5000  | 35.0 × 50.0 × 57.5                             | 24.0                      | 3.2                                  | B32658S8505+414                             | T14           | 56           |
|       |                                     | 5000  | 35.0 × 50.0 × 57.5                             | 24.0                      | 3.2                                  | B32658S8505+415                             | T15           | 56           |
|       |                                     | 5000  | 35.0 × 50.0 × 57.5                             | 24.0                      | 3.2                                  | B32658S8505+416                             | T16           | 56           |
|       |                                     | 5000  | 35.0 × 50.0 × 57.5                             | 24.0                      | 3.2                                  | B32658S8505+417                             | T17           | 56           |
|       |                                     | 5600  | 35.0 × 50.0 × 57.5                             | 27.0                      | 2.8                                  | B32658S8565+414                             | T14           | 56           |
|       |                                     | 5600  | 35.0 × 50.0 × 57.5                             | 27.0                      | 2.8                                  | B32658S8565+415                             | T15           | 56           |
|       |                                     | 5600  | 35.0 × 50.0 × 57.5                             | 27.0                      | 2.8                                  | B32658S8565+416                             | T16           | 56           |
|       |                                     | 5600  | 35.0 × 50.0 × 57.5                             | 27.0                      | 2.8                                  | B32658S8565+417                             | T17           | 56           |
| 1000  | 480                                 | 1000  | 22.5 × 33.0 × 57.5                             | 11.0                      | 8.0                                  | B32658S0105+414                             | T14           | 88           |
|       |                                     | 1000  | 22.5 × 33.0 × 57.5                             | 11.0                      | 8.0                                  | B32658S0105+416                             | T16           | 88           |
|       |                                     | 1500  | 22.5 × 33.0 × 57.5                             | 13.5                      | 6.5                                  | B32658S0155+414                             | T14           | 88           |
|       |                                     | 1500  | 22.5 × 33.0 × 57.5                             | 13.5                      | 6.5                                  | B32658S0155+416                             | T16           | 88           |
|       |                                     | 1800  | 27.0 × 39.5 × 57.5                             | 15.5                      | 6.0                                  | B32658S0185+414                             | T14           | 72           |
|       |                                     | 1800  | 27.0 × 39.5 × 57.5                             | 15.5                      | 6.0                                  | B32658S0185+415                             | T15           | 72           |
|       |                                     | 1800  | 27.0 × 39.5 × 57.5                             | 15.5                      | 6.0                                  | B32658S0185+416                             | T16           | 72           |
|       |                                     | 1800  | 27.0 × 39.5 × 57.5                             | 15.5                      | 6.0                                  | B32658S0185+417                             | T17           | 72           |
|       |                                     | 2200  | 27.0 × 39.5 × 57.5                             | 17.0                      | 5.0                                  | B32658S0225+414                             | T14           | 72           |
|       |                                     | 2200  | 27.0 × 39.5 × 57.5                             | 17.0                      | 5.0                                  | B32658S0225+415                             | T15           | 72           |
|       |                                     | 2200  | 27.0 × 39.5 × 57.5                             | 17.0                      | 5.0                                  | B32658S0225+416                             | T16           | 72           |
|       |                                     | 2200  | 27.0 × 39.5 × 57.5                             | 17.0                      | 5.0                                  | B32658S0225+417                             | T17           | 72           |
|       |                                     | 2700  | 30.0 × 45.0 × 57.5                             | 20.0                      | 4.5                                  | B32658S0275+414                             | T14           | 64           |
|       |                                     | 2700  | 30.0 × 45.0 × 57.5                             | 20.0                      | 4.5                                  | B32658S0275+415                             | T15           | 64           |
|       |                                     | 2700  | 30.0 × 45.0 × 57.5                             | 20.0                      | 4.5                                  | B32658S0275+416                             | T16           | 64           |
|       |                                     | 2700  | 30.0 × 45.0 × 57.5                             | 20.0                      | 4.5                                  | B32658S0275+417                             | T17           | 64           |
|       |                                     | 3000  | 30.0 × 45.0 × 57.5                             | 21.0                      | 4.0                                  | B32658S0305+414                             | T14           | 64           |
|       |                                     | 3000  | 30.0 × 45.0 × 57.5                             | 21.0                      | 4.0                                  | B32658S0305+415                             | T15           | 64           |
|       |                                     | 3000  | 30.0 × 45.0 × 57.5                             | 21.0                      | 4.0                                  | B32658S0305+416                             | T16           | 64           |
|       |                                     | 3000  | 30.0 × 45.0 × 57.5                             | 21.0                      | 4.0                                  | B32658S0305+417                             | T17           | 64           |
|       |                                     | 3300  | 35.0 × 50.0 × 57.5                             | 22.0                      | 4.0                                  | B32658S0335+414                             | T14           | 56           |
|       |                                     | 3300  | 35.0 × 50.0 × 57.5                             | 22.0                      | 4.0                                  | B32658S0335+415                             | T15           | 56           |
|       |                                     | 3300  | 35.0 × 50.0 × 57.5                             | 22.0                      | 4.0                                  | B32658S0335+416                             | T16           | 56           |
|       |                                     | 3300  | 35.0 × 50.0 × 57.5                             | 22.0                      | 4.0                                  | B32658S0335+417                             | T17           | 56           |

MOQ = Minimum Order Quantity, consisting of 4 packing units.

Further E series and intermediate capacitance values on request.

**Composition of ordering code**

+ = Capacitance tolerance code:

K = ±10%

J = ±5%

**B32658S**
**Snubber (wound)**
**Electrical specifications, ordering codes and packing units**

| $V_R$ | $V_{RMS}$<br>$f \leq 1\text{kHz}$ | $C_R$ | Max. dimensions<br>$w \times h \times l$<br>mm | $I_{RMS}$<br>100 kHz<br>A | $ESR_{typ}$<br>100 kHz<br>m $\Omega$ | Ordering code<br>(composition see<br>below) | Ter-<br>minal | pcs./<br>MOQ |
|-------|-----------------------------------|-------|--|---------------------------|--------------------------------------|---|---------------|--------------|
| V DC  | V AC                              | nF    |  |                           |                                      |   |               |              |
| 1000  | 480                               | 4000  | 35.0 × 50.0 × 57.5                             | 24.0                      | 3.5                                  | B32658S0405+414                             | T14           | 56           |
|       |                                   | 4000  | 35.0 × 50.0 × 57.5                             | 24.0                      | 3.5                                  | B32658S0405+415                             | T15           | 56           |
|       |                                   | 4000  | 35.0 × 50.0 × 57.5                             | 24.0                      | 3.5                                  | B32658S0405+416                             | T16           | 56           |
|       |                                   | 4000  | 35.0 × 50.0 × 57.5                             | 24.0                      | 3.5                                  | B32658S0405+417                             | T17           | 56           |
|       |                                   | 4200  | 35.0 × 50.0 × 57.5                             | 24.0                      | 3.5                                  | B32658S0425+414                             | T14           | 56           |
|       |                                   | 4200  | 35.0 × 50.0 × 57.5                             | 24.0                      | 3.5                                  | B32658S0425+415                             | T15           | 56           |
|       |                                   | 4200  | 35.0 × 50.0 × 57.5                             | 24.0                      | 3.5                                  | B32658S0425+416                             | T16           | 56           |
|       |                                   | 4200  | 35.0 × 50.0 × 57.5                             | 24.0                      | 3.5                                  | B32658S0425+417                             | T17           | 56           |
| 1250  | 500                               | 820   | 22.5 × 33.0 × 57.5                             | 11.5                      | 7.5                                  | B32658S7824+414                             | T14           | 88           |
|       |                                   | 820   | 22.5 × 33.0 × 57.5                             | 11.5                      | 7.5                                  | B32658S7824+416                             | T16           | 88           |
|       |                                   | 1000  | 22.5 × 33.0 × 57.5                             | 12.5                      | 7.0                                  | B32658S7105+414                             | T14           | 88           |
|       |                                   | 1000  | 22.5 × 33.0 × 57.5                             | 12.5                      | 7.0                                  | B32658S7105+416                             | T16           | 88           |
|       |                                   | 1200  | 27.0 × 39.5 × 57.5                             | 14.5                      | 7.0                                  | B32658S7125+414                             | T14           | 72           |
|       |                                   | 1200  | 27.0 × 39.5 × 57.5                             | 14.5                      | 7.0                                  | B32658S7125+415                             | T15           | 72           |
|       |                                   | 1200  | 27.0 × 39.5 × 57.5                             | 14.5                      | 7.0                                  | B32658S7125+416                             | T16           | 72           |
|       |                                   | 1200  | 27.0 × 39.5 × 57.5                             | 14.5                      | 7.0                                  | B32658S7125+417                             | T17           | 72           |
|       |                                   | 1500  | 27.0 × 39.5 × 57.5                             | 15.0                      | 6.5                                  | B32658S7155+414                             | T14           | 72           |
|       |                                   | 1500  | 27.0 × 39.5 × 57.5                             | 15.0                      | 6.5                                  | B32658S7155+415                             | T15           | 72           |
|       |                                   | 1500  | 27.0 × 39.5 × 57.5                             | 15.0                      | 6.5                                  | B32658S7155+416                             | T16           | 72           |
|       |                                   | 1500  | 27.0 × 39.5 × 57.5                             | 15.0                      | 6.5                                  | B32658S7155+417                             | T17           | 72           |
|       |                                   | 1800  | 27.0 × 39.5 × 57.5                             | 16.5                      | 5.5                                  | B32658S7185+414                             | T14           | 72           |
|       |                                   | 1800  | 27.0 × 39.5 × 57.5                             | 16.5                      | 5.5                                  | B32658S7185+415                             | T15           | 72           |
|       |                                   | 1800  | 27.0 × 39.5 × 57.5                             | 16.5                      | 5.5                                  | B32658S7185+416                             | T16           | 72           |
|       |                                   | 1800  | 27.0 × 39.5 × 57.5                             | 16.5                      | 5.5                                  | B32658S7185+417                             | T17           | 72           |
|       |                                   | 2200  | 30.0 × 45.0 × 57.5                             | 19.0                      | 4.7                                  | B32658S7225+414                             | T14           | 64           |
|       |                                   | 2200  | 30.0 × 45.0 × 57.5                             | 19.0                      | 4.7                                  | B32658S7225+415                             | T15           | 64           |
|       |                                   | 2200  | 30.0 × 45.0 × 57.5                             | 19.0                      | 4.7                                  | B32658S7225+416                             | T16           | 64           |
|       |                                   | 2200  | 30.0 × 45.0 × 57.5                             | 19.0                      | 4.7                                  | B32658S7225+417                             | T17           | 64           |
|       |                                   | 2700  | 35.0 × 50.0 × 57.5                             | 22.0                      | 4.0                                  | B32658S7275+414                             | T14           | 56           |
|       |                                   | 2700  | 35.0 × 50.0 × 57.5                             | 22.0                      | 4.0                                  | B32658S7275+415                             | T15           | 56           |
|       |                                   | 2700  | 35.0 × 50.0 × 57.5                             | 22.0                      | 4.0                                  | B32658S7275+416                             | T16           | 56           |
|       |                                   | 2700  | 35.0 × 50.0 × 57.5                             | 22.0                      | 4.0                                  | B32658S7275+417                             | T17           | 56           |

MOQ = Minimum Order Quantity, consisting of 4 packing units.

Further E series and intermediate capacitance values on request.

**Composition of ordering code**

+ = Capacitance tolerance code:

K =  $\pm 10\%$ 

J =  $\pm 5\%$

**B32658S**
**Snubber (wound)**
**Electrical specifications, ordering codes and packing units**

| $V_R$ | $V_{RMS}$<br>$f \leq 1\text{kHz}$ | $C_R$ | Max. dimensions<br>$w \times h \times l$ | $I_{RMS}$<br>100 kHz | $ESR_{typ}$<br>100 kHz | Ordering code<br>(composition see<br>below) | Ter-<br>minal | pcs./<br>MOQ |
|-------|-----------------------------------|-------|--|----------------------|------------------------|---|---------------|--------------|
| V DC  | V AC                              | nF    | mm                                       | A                    | m $\Omega$             |   |               |              |
| 1250  | 500                               | 3000  | 35.0 × 50.0 × 57.5                       | 24.0                 | 3.5                    | B32658S7305+414                             | T14           | 56           |
|       |                                   | 3000  | 35.0 × 50.0 × 57.5                       | 24.0                 | 3.5                    | B32658S7305+415                             | T15           | 56           |
|       |                                   | 3000  | 35.0 × 50.0 × 57.5                       | 24.0                 | 3.5                    | B32658S7305+416                             | T16           | 56           |
|       |                                   | 3000  | 35.0 × 50.0 × 57.5                       | 24.0                 | 3.5                    | B32658S7305+417                             | T17           | 56           |
| 1700  | 750                               | 470   | 22.5 × 33.0 × 57.5                       | 11.5                 | 9.0                    | B32658S1474+414                             | T14           | 88           |
|       |                                   | 470   | 22.5 × 33.0 × 57.5                       | 11.5                 | 9.0                    | B32658S1474+416                             | T16           | 88           |
|       |                                   | 680   | 27.0 × 39.5 × 57.5                       | 14.5                 | 7.5                    | B32658S1684+414                             | T14           | 72           |
|       |                                   | 680   | 27.0 × 39.5 × 57.5                       | 14.5                 | 7.5                    | B32658S1684+415                             | T15           | 72           |
|       |                                   | 680   | 27.0 × 39.5 × 57.5                       | 14.5                 | 7.5                    | B32658S1684+416                             | T16           | 72           |
|       |                                   | 680   | 27.0 × 39.5 × 57.5                       | 14.5                 | 7.5                    | B32658S1684+417                             | T17           | 72           |
|       |                                   | 1000  | 30.0 × 45.0 × 57.5                       | 16.5                 | 6.7                    | B32658S1105+414                             | T14           | 64           |
|       |                                   | 1000  | 30.0 × 45.0 × 57.5                       | 16.5                 | 6.7                    | B32658S1105+415                             | T15           | 64           |
|       |                                   | 1000  | 30.0 × 45.0 × 57.5                       | 16.5                 | 6.7                    | B32658S1105+416                             | T16           | 64           |
|       |                                   | 1000  | 30.0 × 45.0 × 57.5                       | 16.5                 | 6.7                    | B32658S1105+417                             | T17           | 64           |
|       |                                   | 1200  | 35.0 × 50.0 × 57.5                       | 18.5                 | 6.2                    | B32658S1125+414                             | T14           | 56           |
|       |                                   | 1200  | 35.0 × 50.0 × 57.5                       | 18.5                 | 6.2                    | B32658S1125+415                             | T15           | 56           |
|       |                                   | 1200  | 35.0 × 50.0 × 57.5                       | 18.5                 | 6.2                    | B32658S1125+416                             | T16           | 56           |
|       |                                   | 1200  | 35.0 × 50.0 × 57.5                       | 18.5                 | 6.2                    | B32658S1125+417                             | T17           | 56           |
|       |                                   | 1400  | 35.0 × 50.0 × 57.5                       | 20.0                 | 5.5                    | B32658S1145+414                             | T14           | 56           |
|       |                                   | 1400  | 35.0 × 50.0 × 57.5                       | 20.0                 | 5.5                    | B32658S1145+415                             | T15           | 56           |
| 1400  | 35.0 × 50.0 × 57.5                | 20.0  | 5.5                                      | B32658S1145+416      | T16                    | 56  |               |              |
| 1400  | 35.0 × 50.0 × 57.5                | 20.0  | 5.5                                      | B32658S1145+417      | T17                    | 56  |               |              |
| 2000  | 800                               | 330   | 22.5 × 33.0 × 57.5                       | 11.5                 | 9.0                    | B32658S2334+414                             | T14           | 88           |
|       |                                   | 330   | 22.5 × 33.0 × 57.5                       | 11.5                 | 9.0                    | B32658S2334+416                             | T16           | 88           |
|       |                                   | 470   | 27.0 × 39.5 × 57.5                       | 14.0                 | 8.0                    | B32658S2474+414                             | T14           | 72           |
|       |                                   | 470   | 27.0 × 39.5 × 57.5                       | 14.0                 | 8.0                    | B32658S2474+415                             | T15           | 72           |
|       |                                   | 470   | 27.0 × 39.5 × 57.5                       | 14.0                 | 8.0                    | B32658S2474+416                             | T16           | 72           |
|       |                                   | 470   | 27.0 × 39.5 × 57.5                       | 14.0                 | 8.0                    | B32658S2474+417                             | T17           | 72           |
|       |                                   | 680   | 30.0 × 45.0 × 57.5                       | 16.5                 | 7.0                    | B32658S2684+414                             | T14           | 64           |

MOQ = Minimum Order Quantity, consisting of 4 packing units.

Further E series and intermediate capacitance values on request.

**Composition of ordering code**

+ = Capacitance tolerance code:

K =  $\pm 10\%$

J =  $\pm 5\%$



**B32658S**  
**Snubber (wound)**

**Electrical specifications, ordering codes and packing units**

| $V_R$ | $V_{RMS}$<br>$f \leq 1\text{kHz}$ | $C_R$              | Max. dimensions<br>$w \times h \times l$<br>mm | $I_{RMS}$<br>100 kHz<br>A | $ESR_{typ}$<br>100 kHz<br>m $\Omega$ | Ordering code<br>(composition see<br>below) | Ter-<br>minal   | pcs./<br>MOQ |    |
|-------|-----------------------------------|--------------------|--|---------------------------|--------------------------------------|---|-----------------|--------------|----|
| V DC  | V AC                              | nF                 |  |                           |                                      |   |                 |              |    |
| 2000  | 800                               | 680                | 30.0 × 45.0 × 57.5                             | 16.5                      | 7.0                                  | B32658S2684+415                             | T15             | 64           |    |
|       |                                   | 680                | 30.0 × 45.0 × 57.5                             | 16.5                      | 7.0                                  | B32658S2684+416                             | T16             | 64           |    |
|       |                                   | 680                | 30.0 × 45.0 × 57.5                             | 16.5                      | 7.0                                  | B32658S2684+417                             | T17             | 64           |    |
|       | 820                               | 820                | 35.0 × 50.0 × 57.5                             | 18.0                      | 6.5                                  | B32658S2824+414                             | T14             | 56           |    |
|       |                                   | 820                | 35.0 × 50.0 × 57.5                             | 18.0                      | 6.5                                  | B32658S2824+415                             | T15             | 56           |    |
|       |                                   | 820                | 35.0 × 50.0 × 57.5                             | 18.0                      | 6.5                                  | B32658S2824+416                             | T16             | 56           |    |
|       |                                   | 820                | 35.0 × 50.0 × 57.5                             | 18.0                      | 6.5                                  | B32658S2824+417                             | T17             | 56           |    |
|       |                                   | 900                | 900  | 35.0 × 50.0 × 57.5        | 19.0                                 | 6.0   | B32658S2904+414 | T14          | 56 |
|       |                                   |                    | 900  | 35.0 × 50.0 × 57.5        | 19.0                                 | 6.0   | B32658S2904+415 | T15          | 56 |
|       | 900                               |                    | 35.0 × 50.0 × 57.5                             | 19.0                      | 6.0                                  | B32658S2904+416                             | T16             | 56           |    |
|       | 900                               | 35.0 × 50.0 × 57.5 | 19.0   | 6.0                       | B32658S2904+417                      | T17   | 56              |              |    |

MOQ = Minimum Order Quantity, consisting of 4 packing units.  
Further E series and intermediate capacitance values on request.

**Composition of ordering code**

- + = Capacitance tolerance code:
- K = ±10%
- J = ±5%



**B32656S ... B32658S**

**Snubber (wound)**

**Technical data**

|  |   |  |  |  |
|--|---|--|--|--|
| Operating temperature range  | Max. operating temperature $T_{op,max}$ +110 °C   |  |  |  |
|  | Upper category temperature $T_{max}$ +100 °C  |  |  |  |
|  | Lower category temperature $T_{min}$ -55 °C   |  |  |  |
|  | Rated temperature $T_R$ +85 °C  |  |  |  |
| Dissipation factor $\tan \delta$ (in $10^{-3}$ )<br>at 20 °C<br>(upper limit values)   | at  | $C_R \leq 0.1 \mu F$   | $0.1 \mu F < C_R \leq 1 \mu F$   | $C_R > 1 \mu F$  |
|  | 1 kHz   | –  | 0.5  | 0.5  |
|  | 10 kHz  | –  | 0.8  | 1.5  |
|  | 100 kHz   | 5.0  | –  | –  |
| Insulation resistance $R_{ins}$<br>or time constant $\tau = C_R \cdot R_{ins}$<br>at 20 °C, rel. humidity $\leq 65\%$<br>(minimum as-delivered values) | $C_R \leq 0.33 \mu F$   |  | $C_R > 0.33 \mu F$   |  |
|  | 100 G $\Omega$  |  | 30000 s  |  |
| DC test voltage  | $1.6 \cdot V_R, 2 s$  |  |  |  |
| Category voltage $V_C$<br>(continuous operation with $V_{DC}$<br>or $V_{AC}$ at $f \leq 1 kHz$ )   | $T_{op} \leq 85$  | DC voltage derating  |  | AC voltage derating  |
|  | $85 < T_{op} \leq 110$  | $V_C = V_R$<br>$V_C = V_R \cdot (165 - T_{op})/80$                       |  | $V_{C,RMS} = V_{RMS}$<br>$V_{C,RMS} = V_{RMS} \cdot (165 - T_{op})/80$             |
| Operating voltage $V_{op}$ for<br>short operating periods<br>( $V_{DC}$ or $V_{AC}$ at $f \leq 1 kHz$ )  | $T_{op} \leq 85$  | DC voltage (max. hours)  |  | AC voltage (max. hours)  |
|  | $85 < T_{op} \leq 100$  | $V_{op} = 1.25 \cdot V_C$ (2000 h)<br>$V_{op} = 1.25 \cdot V_C$ (1000 h) |  | $V_{op} = 1.0 \cdot V_{C,RMS}$ (2000 h)<br>$V_{op} = 1.0 \cdot V_{C,RMS}$ (1000 h) |
| Damp heat test   | 56 days/40 °C/93% relative humidity   |  |  |  |
| Limit values after damp<br>heat test   | Capacitance change $ \Delta C/C $   |  | $\leq 3\%$   |  |
|  | Dissipation factor change $\Delta \tan \delta$  |  | $\leq 0.5 \cdot 10^{-3}$ (at 1 kHz)<br>$\leq 1.0 \cdot 10^{-3}$ (at 10 kHz)    |  |
|  | Insulation resistance $R_{ins}$<br>or time constant $\tau = C_R \cdot R_{ins}$  |  | $\geq 50\%$ of minimum<br>as-delivered values                                  |  |
| Reliability:   |   |  |  |  |
| Failure rate $\lambda$   | 1 fit ( $\leq 1 \cdot 10^{-9}/h$ ) at $0.5 \cdot V_R, 40$ °C  |  |  |  |
| Service life $t_{SL}$  | 200 000 h at $1.0 \cdot V_R, T_{op} = 85$ °C<br>Considered self heating for this product family is 15 °C.<br>For conversion to other operating conditions and temperatures,<br>refer to chapter "Reliability", page . |  |  |  |
| Failure criteria:  |   |  |  |  |
| Total failure  | Short circuit or open circuit   |  |  |  |
| Failure due to variation<br>of parameters  | Capacitance change $ \Delta C/C $   |  | $> 10\%$   |  |
|  | Dissipation factor $\tan \delta$  |  | $> 4 \cdot$ upper limit value  |  |
|  | Insulation resistance $R_{ins}$<br>or time constant $\tau = C_R \cdot R_{ins}$  |  | $< 1500 M\Omega$ ( $C_R \leq 0.33 \mu F$ )<br>$< 500 s$ ( $C_R > 0.33 \mu F$ ) |  |





### Pulse handling capability

"dV/dt" represents the maximum permissible voltage change per unit of time for non-sinusoidal voltages, expressed in V/μs.

"k<sub>0</sub>" represents the maximum permissible pulse characteristic of the waveform applied to the capacitor, expressed in V<sup>2</sup>/μs.

*Note:*

*The values of dV/dt and k<sub>0</sub> provided below must not be exceeded in order to avoid damaging the capacitor.*

#### dV/dt and k<sub>0</sub> values B32656S

| V <sub>R</sub> (V DC) | V <sub>RMS</sub> (V AC) | dV/dt in V/μs | k <sub>0</sub> in V <sup>2</sup> /μs |
|-----------------------|-------------------------|---------------|--------------------------------------|
| 850                   | 450                     | 400           | 680 000                              |
| 1000                  | 480                     | 450           | 900 000                              |
| 1250                  | 500                     | 500           | 1 250 000                            |
| 1700                  | 750                     | 600           | 1 920 000                            |
| 2000                  | 800                     | 700           | 2 800 000                            |

#### dV/dt and k<sub>0</sub> values B32658S

| V <sub>R</sub> (V DC) | V <sub>RMS</sub> (V AC) | dV/dt in V/μs | k <sub>0</sub> in V <sup>2</sup> /μs |
|-----------------------|-------------------------|---------------|--------------------------------------|
| 850                   | 450                     | 275           | 467 500                              |
| 1000                  | 480                     | 300           | 600 000                              |
| 1250                  | 500                     | 350           | 875 000                              |
| 1700                  | 750                     | 400           | 1 360 000                            |
| 2000                  | 800                     | 475           | 1 900 000                            |

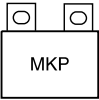

**B32656S ... B32658S**

**Snubber (wound)**

**Impedance Z versus frequency f**  
(typical values)

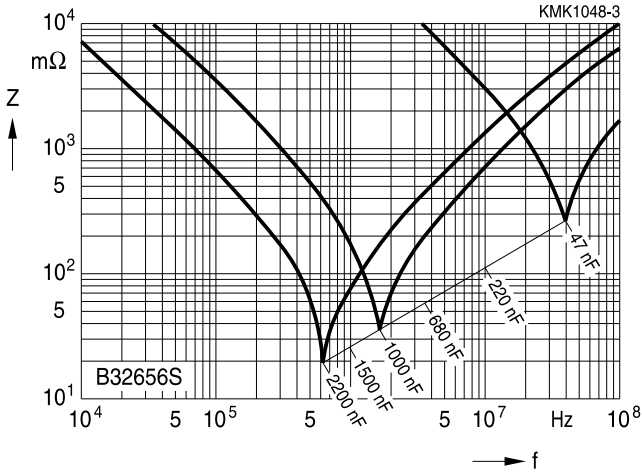

**B32656S**

**Snubber (wound)**



**Permissible AC voltage  $V_{RMS}$  versus frequency  $f$  (for sinusoidal waveforms,  $T_A \leq 90^\circ C$ )**

For  $T_A > 90^\circ C$ , please refer to "General technical information", section 3.2.3.

850 V DC/450 V AC, B32656S8564

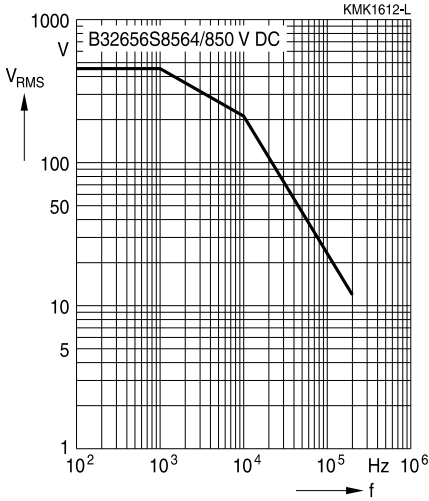

850 V DC/450 V AC, B32656S8185

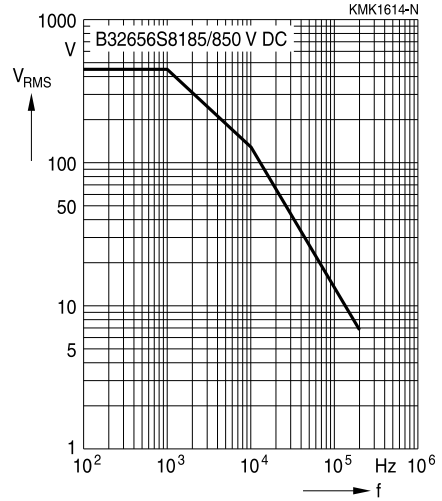

850 V DC/450 V AC, B32656S8335

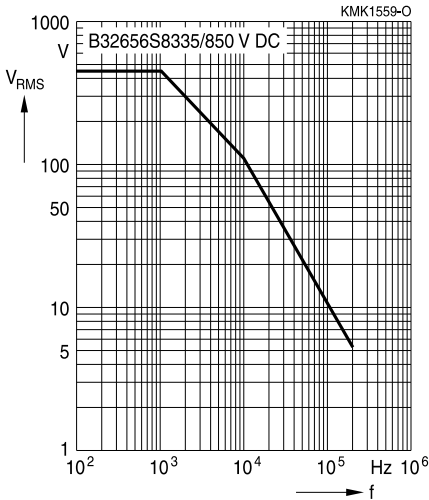



**B32656S**

**Snubber (wound)**

**Permissible AC voltage  $V_{RMS}$  versus frequency  $f$  (for sinusoidal waveforms,  $T_A \leq 90^\circ C$ )**

For  $T_A > 90^\circ C$ , please refer to "General technical information", section 3.2.3.

1000 V DC/480 V AC, B32656S0334



1000 V DC/480 V AC, B32656S0105

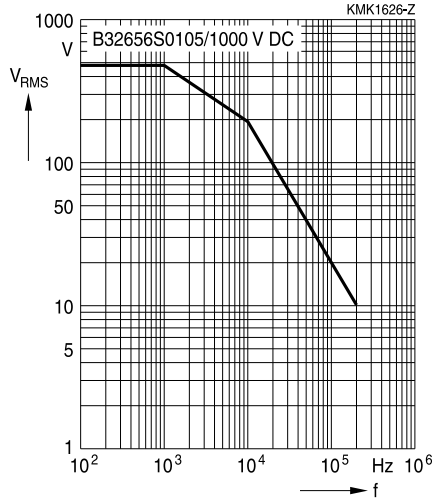

1000 V DC/480 V AC, B32656S0275





**Permissible AC voltage  $V_{RMS}$  versus frequency  $f$  (for sinusoidal waveforms,  $T_A \leq 90^\circ C$ )**

For  $T_A > 90^\circ C$ , please refer to "General technical information", section 3.2.3.

1250 V DC/500 V AC, B32656S7224

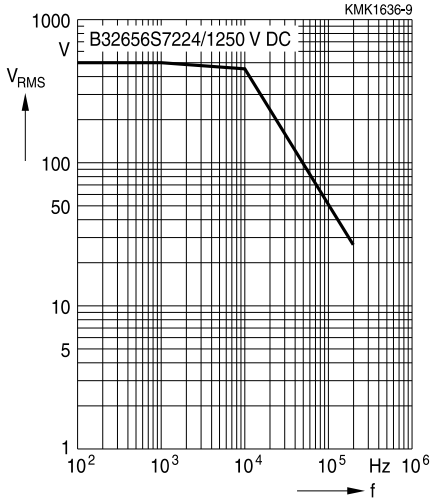

1250 V DC/500 V AC, B32656S7105



1250 V DC/500 V AC, B32656S7185

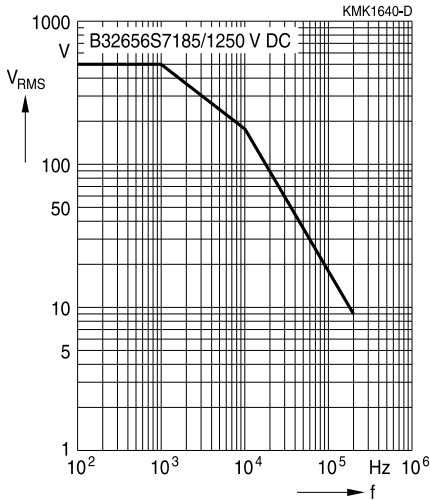



**B32656S**

**Snubber (wound)**

**Permissible AC voltage  $V_{RMS}$  versus frequency  $f$  (for sinusoidal waveforms,  $T_A \leq 90^\circ C$ )**

For  $T_A > 90^\circ C$ , please refer to "General technical information", section 3.2.3.

1700 V DC/750 V AC, B32656S1124



1700 V DC/750 V AC, B32656S1474



1700 V DC/750 V AC, B32656S1824



**B32656S**

**Snubber (wound)**



**Permissible AC voltage  $V_{RMS}$  versus frequency  $f$  (for sinusoidal waveforms,  $T_A \leq 90^\circ C$ )**

For  $T_A > 90^\circ C$ , please refer to "General technical information", section 3.2.3.

2000 V DC/800 V AC, B32656S2683

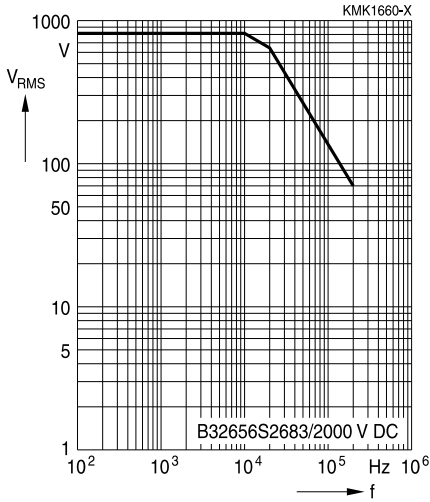

2000 V DC/800 V AC, B32656S2334



2000 V DC/800 V AC, B32656S2564

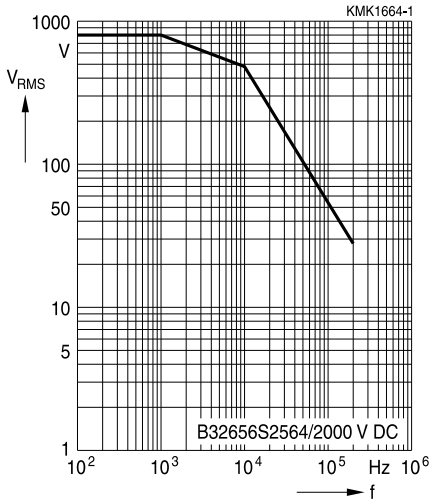



**B32658S**

**Snubber (wound)**

**Permissible AC voltage  $V_{RMS}$  versus frequency  $f$  (for sinusoidal waveforms,  $T_A \leq 90^\circ C$ )**

For  $T_A > 90^\circ C$ , please refer to "General technical information", section 3.2.3.

850 V DC/450 V AC, B32658S8225

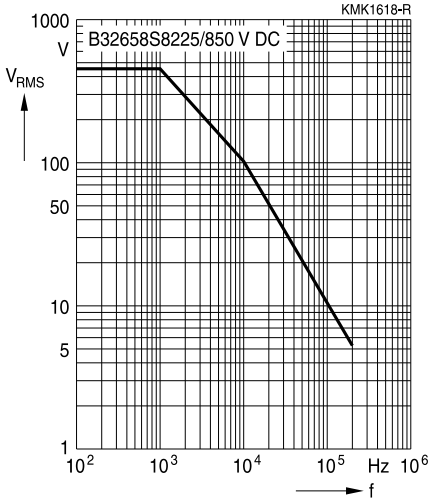

850 V DC/450 V AC, B32658S8405

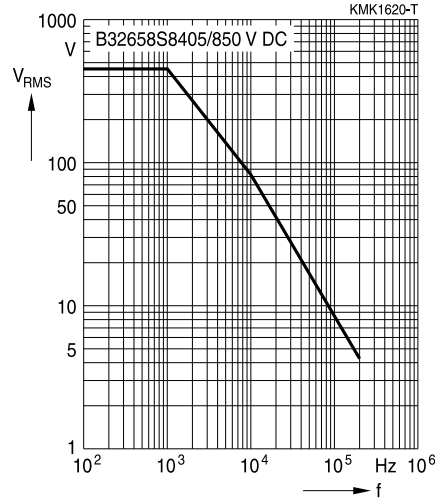

850 V DC/450 V AC, B32658S8565

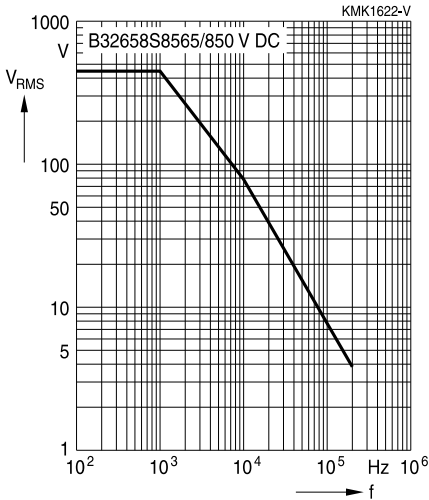





**Permissible AC voltage  $V_{RMS}$  versus frequency  $f$  (for sinusoidal waveforms,  $T_A \leq 90^\circ C$ )**

For  $T_A > 90^\circ C$ , please refer to "General technical information", section 3.2.3.

1000 V DC/480 V AC, B32658S0155

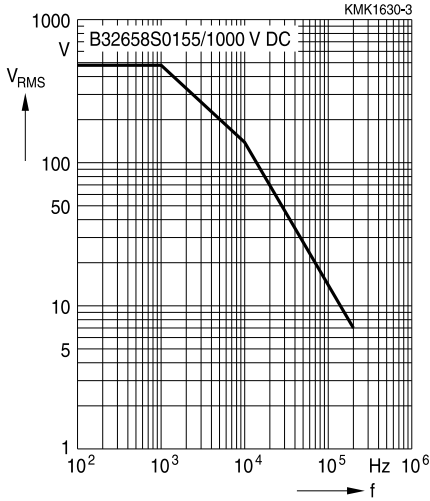

1000 V DC/480 V AC, B32658S0275

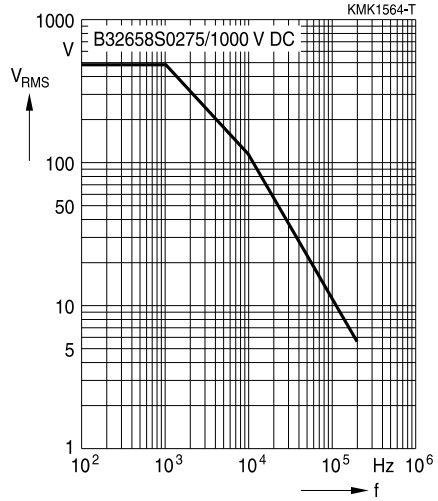

1000 V DC/480 V AC, B32658S0405

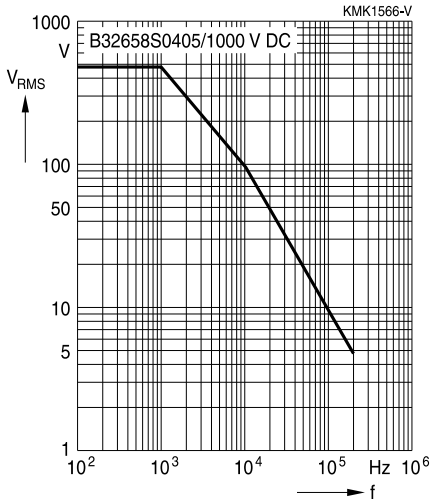



**B32658S**

**Snubber (wound)**

**Permissible AC voltage  $V_{RMS}$  versus frequency  $f$  (for sinusoidal waveforms,  $T_A \leq 90^\circ C$ )**

For  $T_A > 90^\circ C$ , please refer to "General technical information", section 3.2.3.

1250 V DC/500 V AC, B32658S7105



1250 V DC/500 V AC, B32658S7225



1250 V DC/500 V AC, B32658S7305



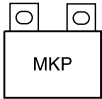

**Permissible AC voltage  $V_{RMS}$  versus frequency  $f$  (for sinusoidal waveforms,  $T_A \leq 90^\circ C$ )**

For  $T_A > 90^\circ C$ , please refer to "General technical information", section 3.2.3.

1700 V DC/500 V AC, B32658S1474



1700 V DC/500 V AC, B32658S1105

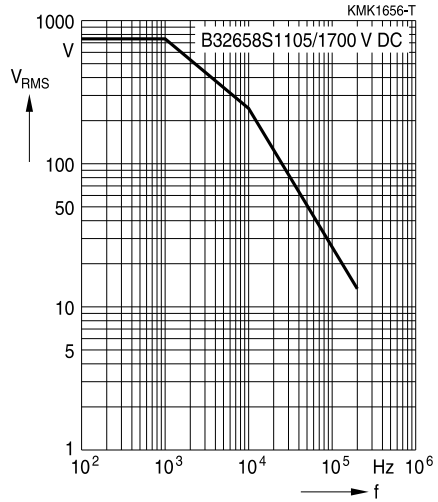

1700 V DC/500 V AC, B32658S1145





**B32658S**

**Snubber (wound)**

**Permissible AC voltage  $V_{RMS}$  versus frequency  $f$  (for sinusoidal waveforms,  $T_A \leq 90^\circ C$ )**

For  $T_A > 90^\circ C$ , please refer to "General technical information", section 3.2.3.

2000 V DC/800 V AC, B32658S2334



2000 V DC/800 V AC, B32658S2684

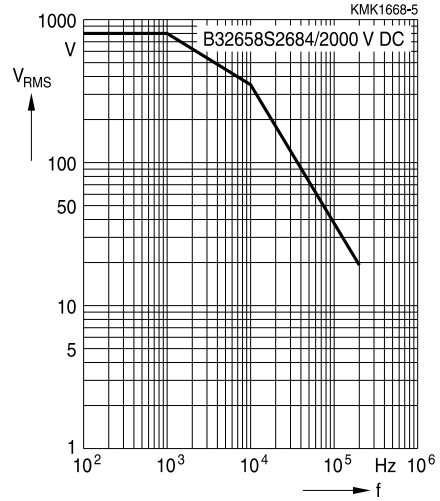

2000 V DC/800 V AC, B32658S2824



**B32656S**

**Snubber (wound)**

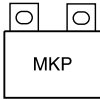

**Permissible current  $I_{RMS}$  versus frequency  $f$  (for sinusoidal waveforms  $T_A \leq 90\text{ }^\circ\text{C}$ )**

For  $T_A > 90\text{ }^\circ\text{C}$ , please use derating factor  $F_T$ .

850 V DC/450 V AC, B32656S8564



850 V DC/450 V AC, B32656S8185



850 V DC/450 V AC, B32656S8335

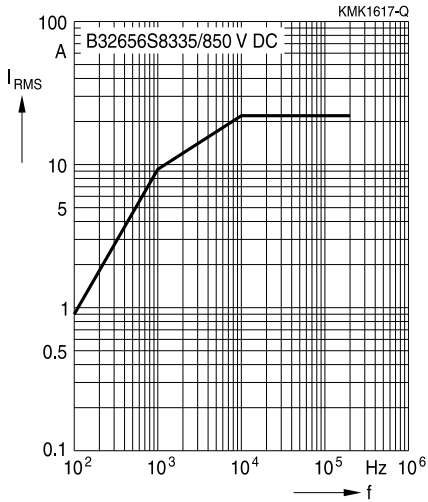



**B32656S**

**Snubber (wound)**

**Permissible current  $I_{RMS}$  versus frequency  $f$  (for sinusoidal waveforms  $T_A \leq 90\text{ }^\circ\text{C}$ )**

For  $T_A > 90\text{ }^\circ\text{C}$ , please use derating factor  $F_T$ .

1000 V DC/480 V AC, B32656S0334

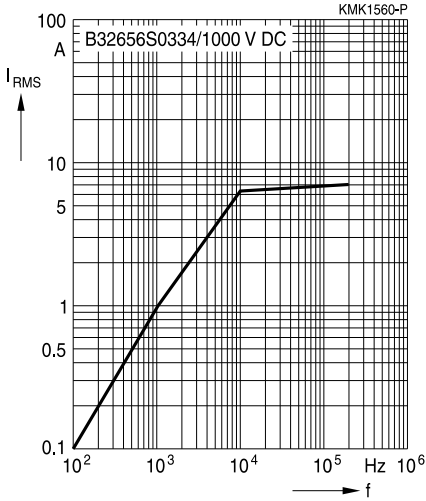

1000 V DC/480 V AC, B32656S0105

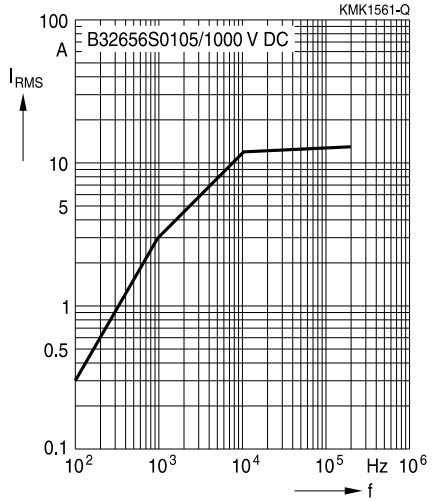

1000 V DC/480 V AC, B32656S0275

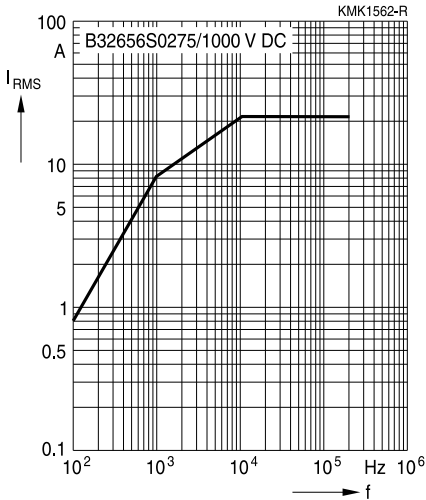

**B32656S**

**Snubber (wound)**

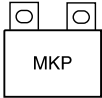

**Permissible current  $I_{RMS}$  versus frequency  $f$  (for sinusoidal waveforms  $T_A \leq 90\text{ }^\circ\text{C}$ )**

For  $T_A > 90\text{ }^\circ\text{C}$ , please use derating factor  $F_T$ .

1250 V DC/500 V AC, B32656S7224

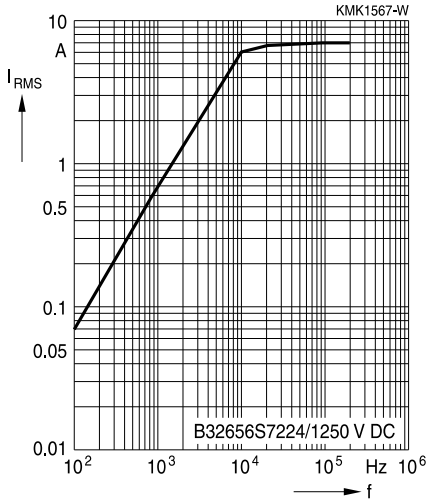

1250 V DC/500 V AC, B32656S7105

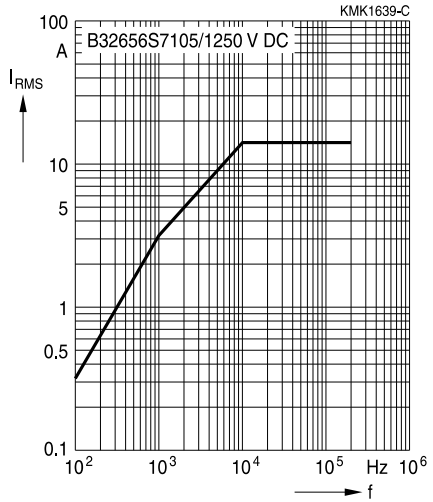

1250 V DC/500 V AC, B32656S7185





**B32656S**

**Snubber (wound)**

**Permissible current  $I_{RMS}$  versus frequency  $f$  (for sinusoidal waveforms  $T_A \leq 90\text{ }^\circ\text{C}$ )**

For  $T_A > 90\text{ }^\circ\text{C}$ , please use derating factor  $F_T$ .

1700 V DC/750 V AC, B32656S1124

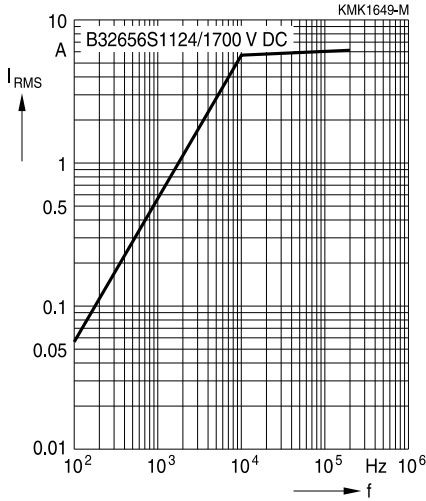

1700 V DC/750 V AC, B32656S1474

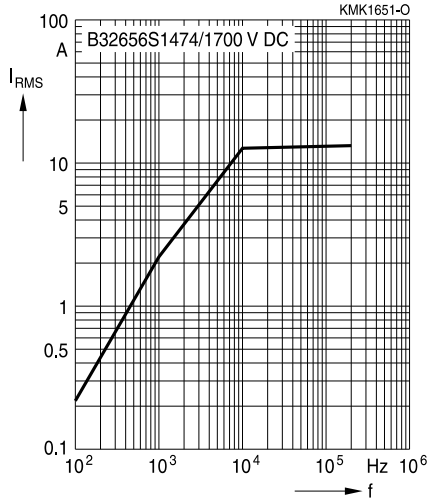

1700 V DC/750 V AC, B32656S1824

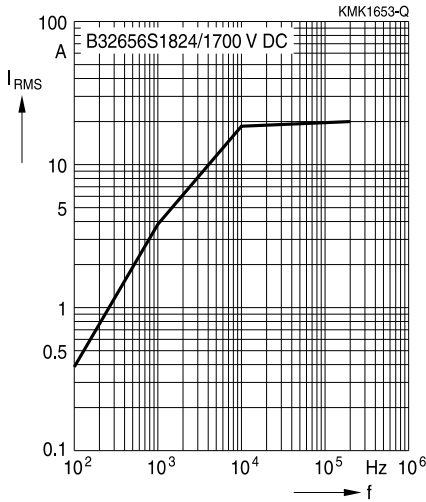



**B32656S**

**Snubber (wound)**



**Permissible current  $I_{RMS}$  versus frequency  $f$  (for sinusoidal waveforms  $T_A \leq 90\text{ }^\circ\text{C}$ )**

For  $T_A > 90\text{ }^\circ\text{C}$ , please use derating factor  $F_T$ .

2000 V DC/800 V AC, B32656S2683

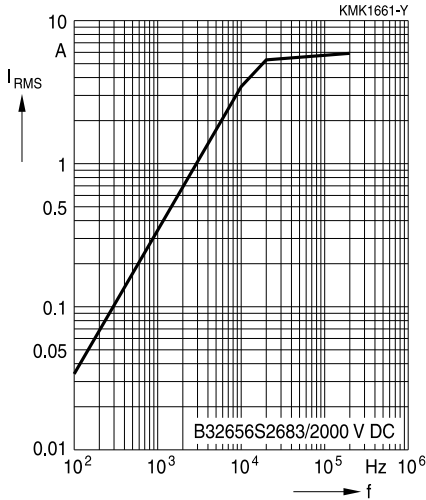

2000 V DC/800 V AC, B32656S2334

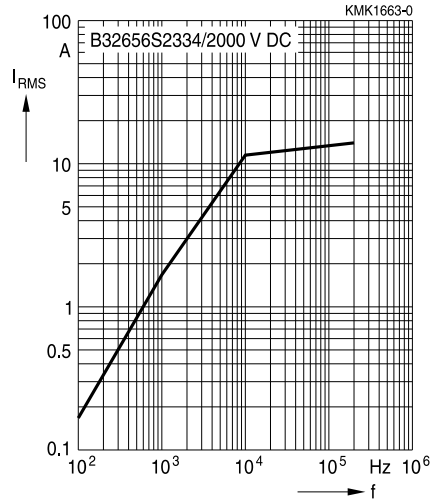

2000 V DC/800 V AC, B32656S2564

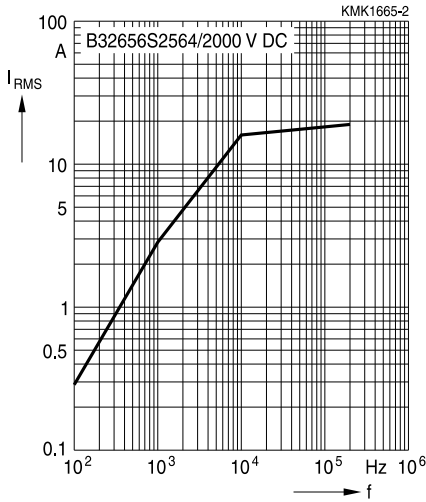



**B32658S**

**Snubber (wound)**

**Permissible current  $I_{RMS}$  versus frequency  $f$  (for sinusoidal waveforms  $T_A \leq 90\text{ }^\circ\text{C}$ )**

For  $T_A > 90\text{ }^\circ\text{C}$ , please use derating factor  $F_T$ .

850 V DC/450 V AC, B32658S8225

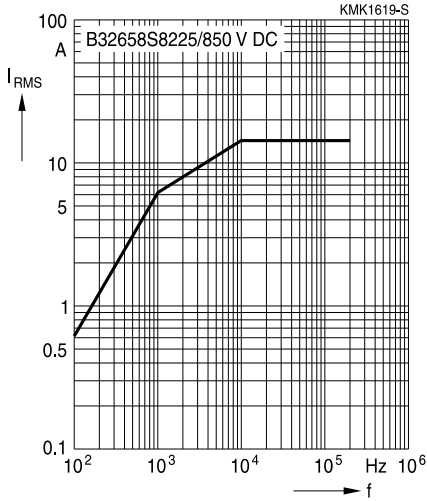

850 V DC/450 V AC, B32658S8405

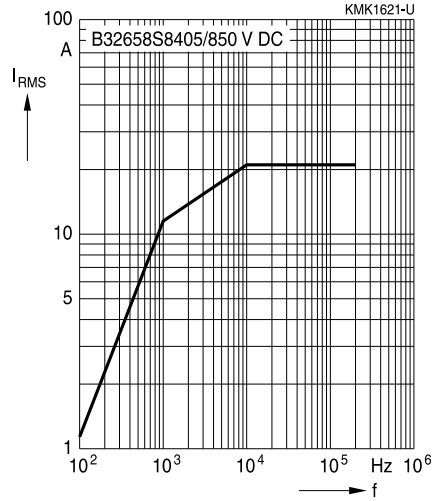

850 V DC/450 V AC, B32658S8565

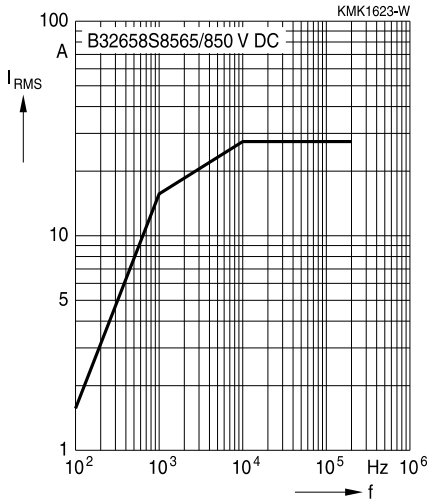



**Permissible current  $I_{RMS}$  versus frequency  $f$  (for sinusoidal waveforms  $T_A \leq 90\text{ }^\circ\text{C}$ )**

For  $T_A > 90\text{ }^\circ\text{C}$ , please use derating factor  $F_T$ .

1000 V DC/480 V AC, B32658S0155



1000 V DC/480 V AC, B32658S0275

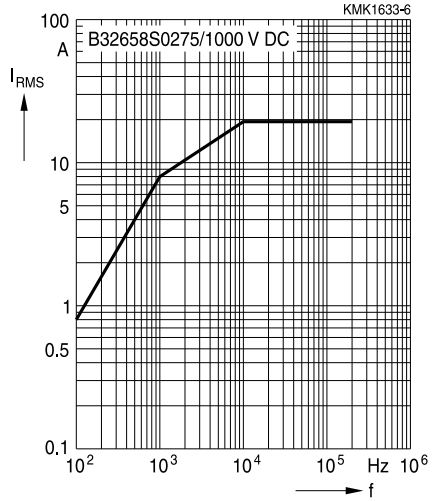

1000 V DC/480 V AC, B32658S0405





**B32658S**

**Snubber (wound)**

**Permissible current  $I_{RMS}$  versus frequency  $f$  (for sinusoidal waveforms  $T_A \leq 90\text{ }^\circ\text{C}$ )**

For  $T_A > 90\text{ }^\circ\text{C}$ , please use derating factor  $F_T$ .

1250 V DC/500 V AC, B32658S7105



1250 V DC/500 V AC, B32658S7225

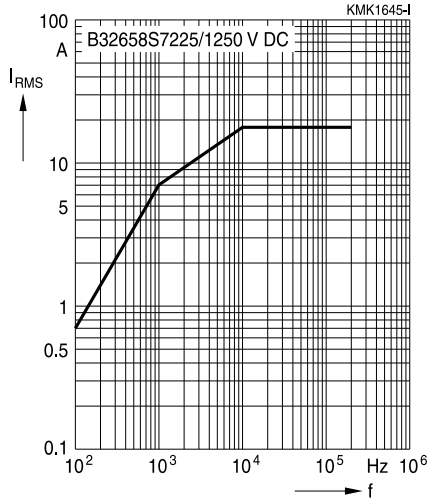

1250 V DC/500 V AC, B32658S7305

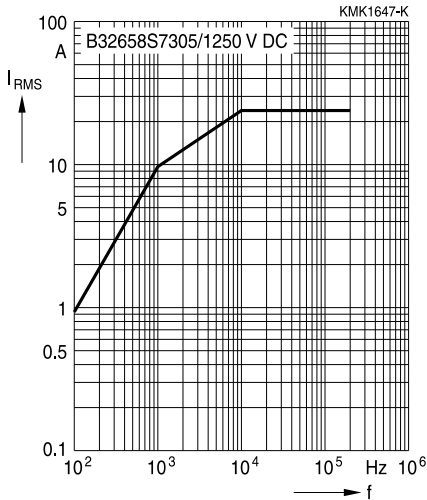

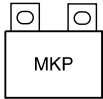

**Permissible current  $I_{RMS}$  versus frequency  $f$  (for sinusoidal waveforms  $T_A \leq 90\text{ }^\circ\text{C}$ )**

For  $T_A > 90\text{ }^\circ\text{C}$ , please use derating factor  $F_T$ .

1700 V DC/500 V AC, B32658S1474

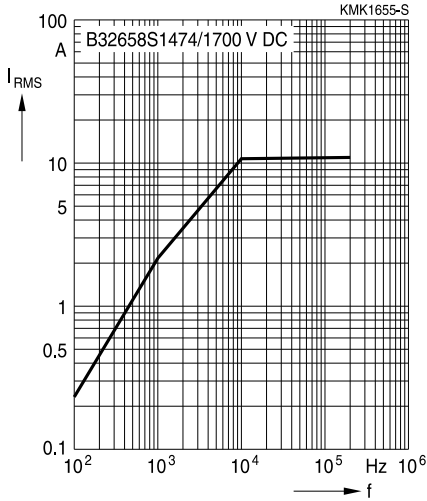

1700 V DC/500 V AC, B32658S1105

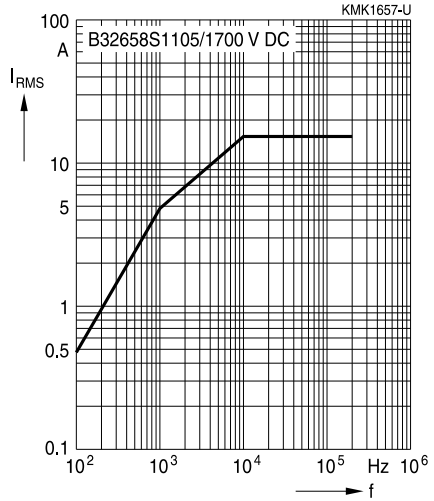

1700 V DC/500 V AC, B32658S1145

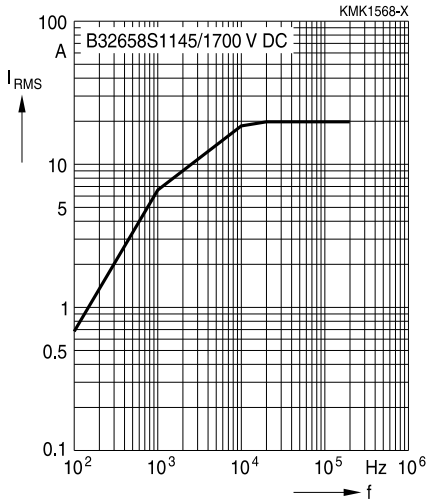



**B32658S**

**Snubber (wound)**

**Permissible current  $I_{RMS}$  versus frequency  $f$  (for sinusoidal waveforms  $T_A \leq 90\text{ }^\circ\text{C}$ )**

For  $T_A > 90\text{ }^\circ\text{C}$ , please use derating factor  $F_T$ .

2000 V DC/800 V AC, B32658S2334



2000 V DC/800 V AC, B32658S2684

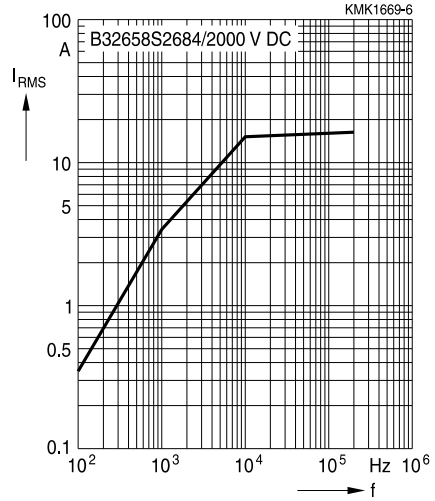

2000 V DC/800 V AC, B32658S2824

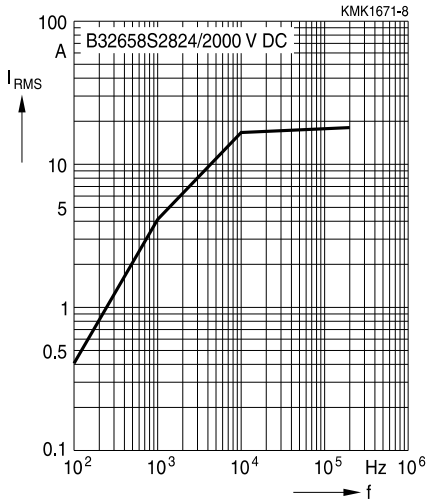



**Maximum AC voltage ( $V_{RMS}$ ), current ( $I_{RMS}$ ) vs. frequency and temperature for  $T_A > 90\text{ }^\circ\text{C}$**

The graphs described in the previous section for the permissible AC voltage ( $V_{RMS}$ ) or current ( $I_{RMS}$ ) vs. frequency are given for a maximum ambient temperature  $T_A \leq 90\text{ }^\circ\text{C}$ . In case of higher ambient temperatures ( $T_A$ ), the self-heating ( $\Delta T$ ) of the component must be reduced to avoid that temperature of the component ( $T_{op} = T_A + \Delta T$ ) reaches values above maximum operating temperature. The factor  $F_T$  shall be applied in the following way:

$$I_{RMS}(T_A) = I_{RMS, T_A \leq 90\text{ }^\circ\text{C}} \cdot F_T(T_A)$$

$$V_{RMS}(T_A) = V_{RMS, T_A \leq 90\text{ }^\circ\text{C}} \cdot F_T(T_A)$$

And  $F_T$  is given by the following curve:

**Curves Characteristics ( $I_{RMS}$  derating vs temperature)**

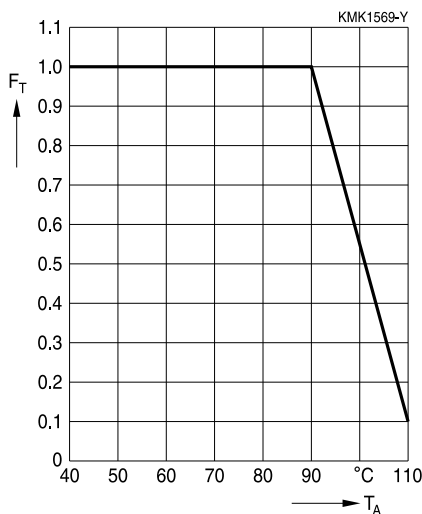

Maximum  $I_{RMS}$  current as function of the ambient temperature:  $I_{RMS}(T_{amb}) = \text{Factor} \times I_{RMS}(90\text{ }^\circ\text{C})$



**B32656S ... B32658S**

**Snubber (wound)**

### Testing and Standards

| Test                                     | Reference      | Conditions of test   | Performance requirements   |
|--|----------------|--|--|
| Electrical Parameters                    | IEC 60384-16   | Voltage proof, $1.6 V_R$ , 1 minute<br>Insulation resistance, $R_{INS}$<br>Capacitance, C<br>Dissipation factor, $\tan \delta$   | Within specified limits  |
| Robustness of terminations               | IEC 60068-2-21 | Only tests Ua1 (20N) and Ud  | Capacitance and $\tan \delta$ within specified limits  |
| Rapid change of temperature              | IEC 60384-16   | $T_A$ = lower category temperature<br>$T_B$ = upper category temperature<br>Five cycles, duration $t = 30$ min   | $ \Delta C/C_0  \leq 2\%$<br>$ \Delta \tan \delta  \leq 0.002$<br>$R_{INS} \geq 50\%$ of initial limit                       |
| Vibration                                | IEC 60384-16   | Test $F_c$ : vibration sinusoidal<br>Displacement: 0.75 mm<br>Acceleration: $98 \text{ m/s}^2$<br>Frequency: 10 Hz ... 500 Hz<br>Test duration: 3 orthogonal axes, 2 hours each axe                                      | No visible damage  |
| Bump                                     | IEC 60384-16   | Test Eb: Total 4000 bumps with $390 \text{ m/s}^2$ mounted on PCB<br>6 ms duration   | No visible damage<br>$ \Delta C/C_0  \leq 2\%$<br>$ \Delta \tan \delta  \leq 0.002$<br>$R_{INS} \geq 50\%$ of initial limit  |
| Climatic sequence                        | IEC 60384-16   | Dry heat $T_b$ / 16 h.<br>Damp heat cyclic, 1st cycle<br>+ $55 \text{ }^\circ\text{C}$ / 24h / 95% ... 100% RH<br>Cold $T_a$ / 2h<br>Damp heat cyclic, 5 cycles<br>+ $55 \text{ }^\circ\text{C}$ / 24h / 95% ... 100% rh | No visible damage<br>$ \Delta C/C_0  \leq 3\%$<br>$ \Delta \tan \delta  \leq 0.003$<br>$R_{INS} \geq 50\%$ of initial limit  |
| Damp Heat Steady State                   | IEC 60384-16   | Test Ca<br>$40 \text{ }^\circ\text{C}$ / 93% RH / 56 days  | No visible damage<br>$ \Delta C/C_0  \leq 3\%$<br>$ \Delta \tan \delta  \leq 0.002$<br>$R_{INS} \geq 50\%$ of initial limit  |
| High temperature high humidity with load |                | $60 \text{ }^\circ\text{C}$ / 95% RH / 1000 hours with $V_{R,DC}$  | No visible damage<br>$ \Delta C/C_0  \leq 10\%$<br>$ \Delta \tan \delta  \leq 0.002$<br>$R_{INS} \geq 50\%$ of initial limit |
| Endurance A                              |                | $85 \text{ }^\circ\text{C}$ / $1.25 V_R$ / 2000 hours  | No visible damage<br>$ \Delta C/C_0  \leq 3\%$<br>$ \Delta \tan \delta  \leq 0.002$<br>$R_{INS} \geq 50\%$ of initial limit  |
| Endurance B                              |                | $110 \text{ }^\circ\text{C}$ / $1.25 V_C$ / 2000 hours   | No visible damage<br>$ \Delta C/C_0  \leq 3\%$<br>$ \Delta \tan \delta  \leq 0.002$<br>$R_{INS} \geq 50\%$ of initial limit  |





### Cautions and warnings

- Do not exceed the upper category temperature (UCT).
- Do not apply any mechanical stress to the capacitor terminals.
- Avoid any compressive, tensile or flexural stress.
- Do not move the capacitor after it has been soldered to the PC board.
- Do not pick up the PC board by the soldered capacitor.
- Do not place the capacitor on a PC board whose PTH hole spacing differs from the specified lead spacing.
- Do not exceed the specified time or temperature limits during soldering.
- Avoid external energy inputs, such as fire or electricity.
- Avoid overload of the capacitors.

The table below summarizes the safety instructions that must always be observed. A detailed description can be found in the relevant sections of the chapters "General technical information" and "Mounting guidelines".

| Topic                   | Safety information  | Reference chapter "General technical information" |
|-------------------------|---|---|
| Storage conditions      | Make sure that capacitors are stored within the specified range of time, temperature and humidity conditions.   | 4.5<br>"Storage conditions"                       |
| Flammability            | Avoid external energy, such as fire or electricity (passive flammability), avoid overload of the capacitors (active flammability) and consider the flammability of materials.   | 5.3<br>"Flammability"                             |
| Resistance to vibration | Do not exceed the tested ability to withstand vibration. The capacitors are tested to IEC 60068-2-6.<br>EPCOS offers film capacitors specially designed for operation under more severe vibration regimes such as those found in automotive applications. Consult our catalog "Film Capacitors for Automotive Electronics". | 5.2<br>"Resistance to vibration"                  |

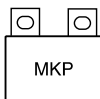

**B32656S ... B32658S**

**Snubber (wound)**

| Topic  | Safety information  | Reference chapter<br>"Mounting guidelines"         |
|--|---|--|
| Soldering                                      | Do not exceed the specified time or temperature limits during soldering.  | 1 "Soldering"                                      |
| Cleaning                                       | Use only suitable solvents for cleaning capacitors.   | 2 "Cleaning"                                       |
| Embedding of capacitors in finished assemblies | When embedding finished circuit assemblies in plastic resins, chemical and thermal influences must be taken into account.<br>Caution: Consult us first, if you also wish to embed other uncoated component types! | 3 "Embedding of capacitors in finished assemblies" |

### Display of ordering codes for EPCOS products

The ordering code for one and the same product can be represented differently in data sheets, data books, other publications and the website of EPCOS, or in order-related documents such as shipping notes, order confirmations and product labels. **The varying representations of the ordering codes are due to different processes employed and do not affect the specifications of the respective products.** Detailed information can be found on the Internet under [www.epcos.com/orderingcodes](http://www.epcos.com/orderingcodes).

**Symbols and terms**

| Symbol               | English   | German  |
|----------------------|---|---|
| $\alpha$             | Heat transfer coefficient   | Wärmeübergangszahl  |
| $\alpha_C$           | Temperature coefficient of capacitance                                    | Temperaturkoeffizient der Kapazität   |
| A                    | Capacitor surface area  | Kondensatoroberfläche   |
| $\beta_C$            | Humidity coefficient of capacitance                                       | Feuchtekoeffizient der Kapazität  |
| C                    | Capacitance   | Kapazität   |
| $C_R$                | Rated capacitance   | Nennkapazität   |
| $\Delta C$           | Absolute capacitance change   | Absolute Kapazitätsänderung   |
| $\Delta C/C$         | Relative capacitance change (relative deviation of actual value)          | Relative Kapazitätsänderung (relative Abweichung vom Ist-Wert)                  |
| $\Delta C/C_R$       | Capacitance tolerance (relative deviation from rated capacitance)         | Kapazitätstoleranz (relative Abweichung vom Nennwert)                           |
| dt                   | Time differential   | Differentielle Zeit   |
| $\Delta t$           | Time interval   | Zeitintervall   |
| $\Delta T$           | Absolute temperature change (self-heating)                                | Absolute Temperaturänderung (Selbsterwärmung)                                   |
| $\Delta \tan \delta$ | Absolute change of dissipation factor                                     | Absolute Änderung des Verlustfaktors  |
| $\Delta V$           | Absolute voltage change   | Absolute Spannungsänderung  |
| dV/dt                | Time differential of voltage function (rate of voltage rise)              | Differentielle Spannungsänderung (Spannungsflankensteilheit)                    |
| $\Delta V/\Delta t$  | Voltage change per time interval  | Spannungsänderung pro Zeitintervall   |
| E                    | Activation energy for diffusion   | Aktivierungsenergie zur Diffusion   |
| ESL                  | Self-inductance   | Eigeninduktivität   |
| ESR                  | Equivalent series resistance  | Ersatz-Serienwiderstand   |
| f                    | Frequency   | Frequenz  |
| $f_1$                | Frequency limit for reducing permissible AC voltage due to thermal limits | Grenzfrequenz für thermisch bedingte Reduzierung der zulässigen Wechselspannung |
| $f_2$                | Frequency limit for reducing permissible AC voltage due to current limit  | Grenzfrequenz für strombedingte Reduzierung der zulässigen Wechselspannung      |
| $f_r$                | Resonant frequency  | Resonanzfrequenz  |
| $F_D$                | Thermal acceleration factor for diffusion                                 | Therm. Beschleunigungsfaktor zur Diffusion                                      |
| $F_T$                | Derating factor   | Deratingfaktor  |
| i                    | Current (peak)  | Stromspitze   |
| $I_C$                | Category current (max. continuous current)                                | Kategoriestrom (max. Dauerstrom)  |

**B32656S ... B32658S**
**Snubber (wound)**

| Symbol           | English  | German  |
|------------------|--|---|
| $I_{RMS}$        | (Sinusoidal) alternating current, root-mean-square value | (Sinusförmiger) Wechselstrom                      |
| $i_z$            | Capacitance drift  | Inkonstanz der Kapazität                          |
| $k_0$            | Pulse characteristic                                     | Impuls Kennwert                                   |
| $L_S$            | Series inductance  | Serieninduktivität                                |
| $\lambda$        | Failure rate   | Ausfallrate                                       |
| $\lambda_0$      | Constant failure rate during useful service life         | Konstante Ausfallrate in der Nutzungsphase        |
| $\lambda_{test}$ | Failure rate, determined by tests                        | Experimentell ermittelte Ausfallrate              |
| $P_{diss}$       | Dissipated power   | Abgegebene Verlustleistung                        |
| $P_{gen}$        | Generated power  | Erzeugte Verlustleistung                          |
| $Q$              | Heat energy  | Wärmeenergie                                      |
| $\rho$           | Density of water vapor in air                            | Dichte von Wasserdampf in Luft                    |
| $R$              | Universal molar constant for gases                       | Allg. Molarkonstante für Gas                      |
| $R$              | Ohmic resistance of discharge circuit                    | Ohmscher Widerstand des Entladekreises            |
| $R_i$            | Internal resistance                                      | Innenwiderstand                                   |
| $R_{ins}$        | Insulation resistance                                    | Isolationswiderstand                              |
| $R_P$            | Parallel resistance                                      | Parallelwiderstand                                |
| $R_S$            | Series resistance  | Serienwiderstand                                  |
| $S$              | severity (humidity test)                                 | Schärfegrad (Feuchtest)                           |
| $t$              | Time   | Zeit  |
| $T$              | Temperature  | Temperatur  |
| $\tau$           | Time constant  | Zeitkonstante                                     |
| $\tan \delta$    | Dissipation factor                                       | Verlustfaktor                                     |
| $\tan \delta_D$  | Dielectric component of dissipation factor               | Dielektrischer Anteil des Verlustfaktors          |
| $\tan \delta_P$  | Parallel component of dissipation factor                 | Parallelanteil des Verlustfaktors                 |
| $\tan \delta_S$  | Series component of dissipation factor                   | Serienanteil des Verlustfaktors                   |
| $T_A$            | Temperature of the air surrounding the component         | Temperatur der Luft, die das Bauteil umgibt       |
| $T_{max}$        | Upper category temperature                               | Obere Kategorietemperatur                         |
| $T_{min}$        | Lower category temperature                               | Untere Kategorietemperatur                        |
| $t_{OL}$         | Operating life at operating temperature and voltage      | Betriebszeit bei Betriebstemperatur und -spannung |
| $T_{op}$         | Operating temperature                                    | Betriebstemperatur                                |
| $T_R$            | Rated temperature  | Nenntemperatur                                    |
| $T_{ref}$        | Reference temperature                                    | Referenztemperatur                                |
| $t_{SL}$         | Reference service life                                   | Referenz-Lebensdauer                              |



| Symbol      | English   | German                                      |
|-------------|---|---|
| $V_{AC}$    | AC voltage  | Wechselspannung                             |
| $V_C$       | Category voltage  | Kategorie <span>spannung</span>             |
| $V_{C,RMS}$ | Category AC voltage   | (Sinusförmige)<br>Kategorie-Wechselspannung |
| $V_{CD}$    | Corona-discharge onset voltage                              | Teilentlade-Einsatzspannung                 |
| $V_{ch}$    | Charging voltage  | Ladespannung                                |
| $V_{DC}$    | DC voltage  | Gleichspannung                              |
| $V_{FB}$    | Fly-back capacitor voltage                                  | Spannung (Flyback)                          |
| $V_i$       | Input voltage   | Eingangsspannung                            |
| $V_o$       | Output voltage  | Ausgangssspannung                           |
| $V_{op}$    | Operating voltage   | Betriebsspannung                            |
| $V_p$       | Peak pulse voltage  | Impuls-Spitzen <span>spannung</span>        |
| $V_{pp}$    | Peak-to-peak voltage Impedance                              | Spannungshub                                |
| $V_R$       | Rated voltage   | Nennspannung                                |
| $\hat{V}_R$ | Amplitude of rated AC voltage                               | Amplitude der Nenn-Wechselspannung          |
| $V_{RMS}$   | (Sinusoidal) alternating voltage,<br>root-mean-square value | (Sinusförmige) Wechselspannung              |
| $V_{SC}$    | S-correction voltage  | Spannung bei Anwendung "S-correction"       |
| $V_{sn}$    | Snubber capacitor voltage                                   | Spannung bei Anwendung<br>"Beschaltung"     |
| $Z$         | Impedance   | Schein <span>widerstand</span>              |
| $e$         | Lead spacing  | Rastermaß                                   |

## Important notes

The following applies to all products named in this publication:

1. Some parts of this publication contain **statements about the suitability of our products for certain areas of application**. These statements are based on our knowledge of typical requirements that are often placed on our products in the areas of application concerned. We nevertheless expressly point out **that such statements cannot be regarded as binding statements about the suitability of our products for a particular customer application**. As a rule, EPCOS is either unfamiliar with individual customer applications or less familiar with them than the customers themselves. For these reasons, it is always ultimately incumbent on the customer to check and decide whether an EPCOS product with the properties described in the product specification is suitable for use in a particular customer application.
2. We also point out that **in individual cases, a malfunction of electronic components or failure before the end of their usual service life cannot be completely ruled out in the current state of the art, even if they are operated as specified**. In customer applications requiring a very high level of operational safety and especially in customer applications in which the malfunction or failure of an electronic component could endanger human life or health (e.g. in accident prevention or lifesaving systems), it must therefore be ensured by means of suitable design of the customer application or other action taken by the customer (e.g. installation of protective circuitry or redundancy) that no injury or damage is sustained by third parties in the event of malfunction or failure of an electronic component.
3. **The warnings, cautions and product-specific notes must be observed.**
4. In order to satisfy certain technical requirements, **some of the products described in this publication may contain substances subject to restrictions in certain jurisdictions (e.g. because they are classed as hazardous)**. Useful information on this will be found in our Material Data Sheets on the Internet ([www.epcos.com/material](http://www.epcos.com/material)). Should you have any more detailed questions, please contact our sales offices.
5. We constantly strive to improve our products. Consequently, **the products described in this publication may change from time to time**. The same is true of the corresponding product specifications. Please check therefore to what extent product descriptions and specifications contained in this publication are still applicable before or when you place an order. We also **reserve the right to discontinue production and delivery of products**. Consequently, we cannot guarantee that all products named in this publication will always be available. The aforementioned does not apply in the case of individual agreements deviating from the foregoing for customer-specific products.
6. Unless otherwise agreed in individual contracts, **all orders are subject to the current version of the "General Terms of Delivery for Products and Services in the Electrical Industry" published by the German Electrical and Electronics Industry Association (ZVEI)**.

## Important notes

7. The trade names EPCOS, Alu-X, CeraDiode, CeraLink, CeraPad, CeraPlas, CSMP, CSSP, CTVS, DeltaCap, DigiSiMic, DSSP, ExoCore, FilterCap, FormFit, LeaXield, MiniBlue, MiniCell, MKD, MKK, MotorCap, PCC, PhaseCap, PhaseCube, PhaseMod, PhiCap, PQSine, SIFERRIT, SIFI, SIKOREL, SilverCap, SIMDAD, SiMic, SIMID, SineFormer, SIOV, SIP5D, SIP5K, TFAP, ThermoFuse, WindCap are **trademarks registered or pending** in Europe and in other countries. Further information will be found on the Internet at [www.epcos.com/trademarks](http://www.epcos.com/trademarks).

# Mouser Electronics

Authorized Distributor

Click to View Pricing, Inventory, Delivery & Lifecycle Information:

## EPCOS / TDK:

[B32656S105J561](#) [B32656S105J564](#) [B32656S105K562](#) [B32656S105K563](#) [B32656S105K565](#) [B32656S125J561](#)  
[B32656S125K561](#) [B32656S125K562](#) [B32656S125K563](#) [B32656S125K564](#) [B32656S125K565](#) [B32656S155K561](#)  
[B32656S155K562](#) [B32656S155K563](#) [B32656S185J561](#) [B32656S185K561](#) [B32656S474J565](#) [B32656S474K563](#)  
[B32656S474K564](#) [B32656S474K565](#) [B32656S684J564](#) [B32656S684J565](#) [B32656S684K563](#) [B32656S684K565](#)  
[B32656S7145K561](#) [B32656S8255K563](#) [B32656S7474K561](#) [B32656S0105K561](#) [B32656S0105K562](#)  
[B32656S0105K563](#) [B32656S0105K564](#) [B32656S0105K565](#) [B32656S0125K561](#) [B32656S0125K562](#)  
[B32656S0125K563](#) [B32656S0125K564](#) [B32656S0125K565](#) [B32656S0155K561](#) [B32656S0155K562](#)  
[B32656S0155K563](#) [B32656S0474K563](#) [B32656S0474K564](#) [B32656S0474K565](#) [B32656S0684K563](#)  
[B32656S0684K564](#) [B32656S0684K565](#) [B32656S7105K561](#) [B32656S7105K562](#) [B32656S7105K563](#)  
[B32656S7224K563](#) [B32656S7224K564](#) [B32656S7224K565](#) [B32656S7684K561](#) [B32656S7684K562](#)  
[B32656S7684K563](#) [B32656S7684K564](#) [B32656S7684K565](#) [B32656S8155J561](#) [B32656S8225J561](#)  
[B32656S7474J564](#) [B32656S7474J565](#) [B32656S7105J561](#) [B32656S2104J564](#) [B32656S2224J561](#)  
[B32656S2474J561](#) [B32656S8824K565](#) [B32656S8155K561](#) [B32656S8225K561](#) [B32656S7334K565](#)  
[B32656S7564K561](#) [B32656S7564K562](#) [B32656S7125K561](#) [B32656S7125K562](#) [B32656S1334K561](#)  
[B32656S1334K565](#) [B32656S1474K561](#) [B32656S2104K564](#) [B32656S2224K561](#) [B32656S2334K561](#)  
[B32656S2474K561](#) [B32656S2474K562](#) [B32656S1684K561](#) [B32656S1684K563](#) [B32656S105K561](#)  
[B32656S105K564](#) [B32656S155J561](#) [B32656S205J561](#) [B32656S684K564](#) [B32656S8255K561](#) [B32656S8255K562](#)  
[B32656S1224K565](#) [B32656S7105J563](#) [B32656S7474K565](#) [B32656S8185K562](#) [B32656S1104K564](#)  
[B32656S2104J563](#) [B32656S7125K563](#) [B32656S8125K565](#) [B32656S2104K563](#) [B32656S2154K563](#)