

CHROMA SIGNAL HUE TINT CONTROLLER

■ GENERAL DESCRIPTION

NJM2255 is a Chroma signal Hue, Tint controller IC, to be used for VCR, LCD & AV equipments.

In play back operation of video signals of VCRs, Hue and Tint of Chroma signal can be adjusted independently and continuously by the external DC voltage. **NJM2255** internalizes the variable capacitor in it, so that it can be operated with minimal external components.

■ PACKAGE OUTLINE

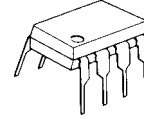

NJM2255D

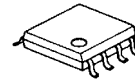

NJM2255M

■ FEATURES

- Operating Voltage (+4.7V to +5.3V)
- Internalizing variable capacitor
- Internalizing changeable Gain Amplifier
- Hue and Tint of Chroma signals can be adjusted continuously by DC voltage (0V to 5V)
- Internalizing Dead Band Circuit
- Package Outline DIP8, DMP8
- Bipolar Technology

■ APPLICATIONS

- VCR, LCD, AV equipments

■ BLOCK DIAGRAM

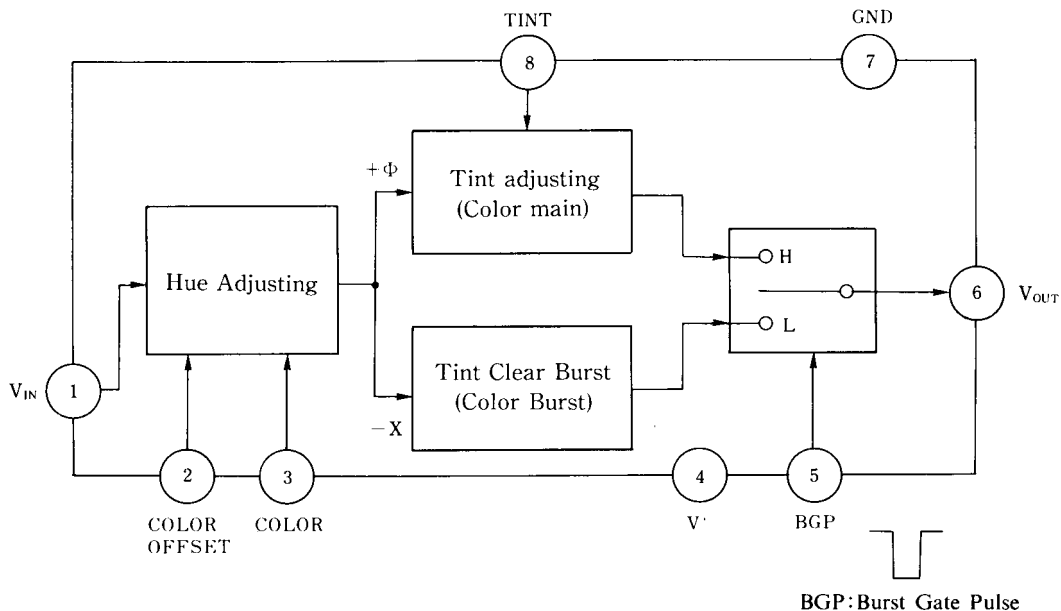

■ CONTROL INPUT - OUTPUT SIGNAL

SW1	Output Signal
H	Color Main
L	Color Burst

NJM2255

■ TEST CIRCUIT

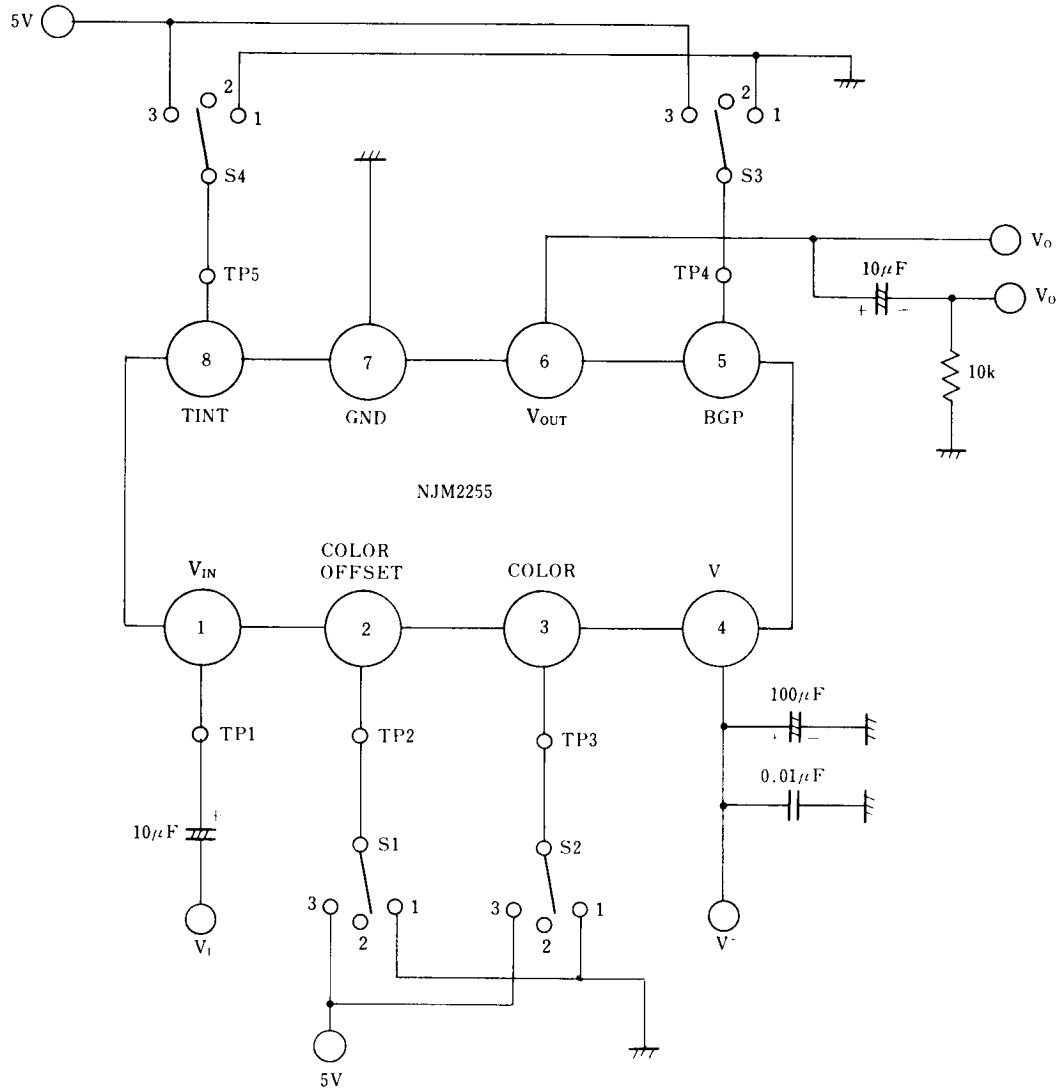

■ ABSOLUTE MAXIMUM RATINGS

($T_a = 25^\circ\text{C}$)

PARAMETER	SYMBOL	RATINGS	UNIT
Supply Voltage	V^+	7	V
Power Dissipation	P_D	500	mW
Operating Temperature Range	T_{opr}	-20 to +75	$^\circ\text{C}$
Storage Temperature Range	T_{stg}	-40 to +125	$^\circ\text{C}$

■ ELECTRICAL CHARACTERISTICS

($V^+ = 5\text{V}$, $T_a = 25^\circ\text{C}$)

PARAMETER	SYMBOL	SWITCH				TEST CONDITION	MIN.	TYP.	MAX.	UNIT
		S1	S2	S3	S4					
Operating Current	I_{cc}	2	2	2	2	No signal	-	22.0	28.0	mA
Voltage Gain 1	GC	2	2	3	2	V_{OUT} / V_{IN}	-1.0	0	1.0	dB
Voltage Gain 2	GB	2	2	1	2	V_{OUT} / V_{IN}	-1.0	0	1.0	dB
Hue Offset	T1	2	2		2	$S3 = 1 / 3 V_{OUT}$ Phase difference	-3.5	0	3.5	deg
Hue Changeable width 1	T2	2	3		2	$S3 = 1 / 3 V_{OUT}$ Phase difference	20	22	-	deg
Hue Changeable width 2	T3	2	1		2	$S3 = 1 / 3 V_{OUT}$ Phase difference	-	-22	-20	deg
Tint Changeable width 1	GC	2	2		2	Gain ($S3 = 3$) - Gain ($S3 = 1$)	-0.6	0	0.6	dB
Tint Changeable width 2	GB	2	2		3	Gain ($S3 = 3$) - Gain ($S3 = 1$)	4.5	5.5	-	dB
Tint Changeable width 3	T1	2	2		1	Gain ($S3 = 3$) - Gain ($S3 = 1$)	-	-	-20	dB
Hue Offset Adjustment width 1	OSTH	3	2		2	$S3 = 1 / 3 V_{OUT}$	-	-	-3.5	deg
Hue Offset Adjustment width 2	OSTL	1	2		2	$S3 = 1 / 3 V_{OUT}$	3.5	-	-	deg
BGP Threshold Voltage 1	VTHH	2	2	3	2	Switch on level	2.2	-	5.0	V
BGP Threshold Voltage 2	VTHL	2	2	3	2	Switch off level	0	-	0.8	V
Secondary Distortion 1	HC	2	2	3	2	3.58MHz, 700mV _{P-P} Sine Wave	-	-37	-33	dB
Secondary Distortion 2	HB	2	2	1	2	3.58MHz, 700mV _{P-P} Sine Wave	-	-37	-33	dB

Note Unless otherwise specified, input signal is 3.58MHz and 300mV_{P-P} sine wave.

■ TYPICAL CHARACTERISTICS

Hue Control Voltage vs. Tint Changeable feature

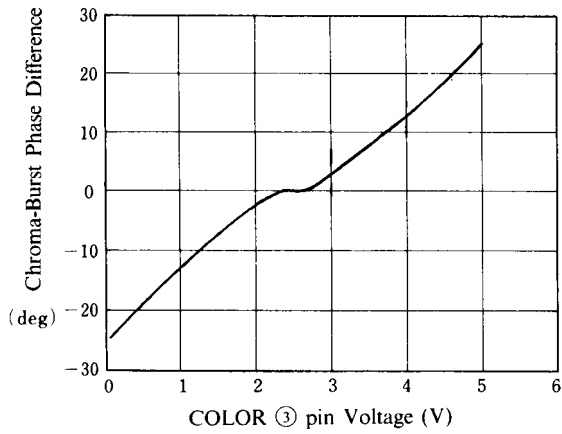

Hue Control Voltage vs. Input Delay feature

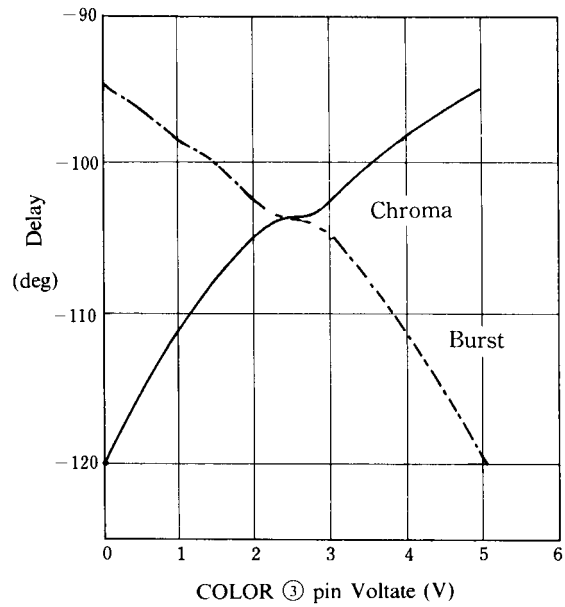

Color Control Voltage vs. Chroma Gain Changeable

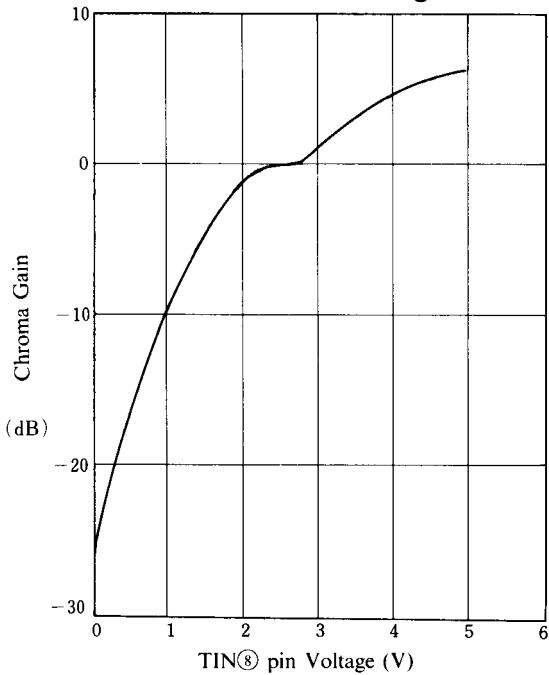

[CAUTION]

The specifications on this databook are only given for information, without any guarantee as regards either mistakes or omissions. The application circuits in this databook are described only to show representative usages of the product and not intended for the guarantee or permission of any right including the industrial rights.

Mouser Electronics

Authorized Distributor

Click to View Pricing, Inventory, Delivery & Lifecycle Information:

[NJR:](#)

[NJM2255M-TE2](#) [NJM2255D](#) [NJM2255M](#)