

REVISIONS		
LTR	DESCRIPTION	DATE
A	INITIAL RELEASE PER ECO-11-016336	08/10/2011

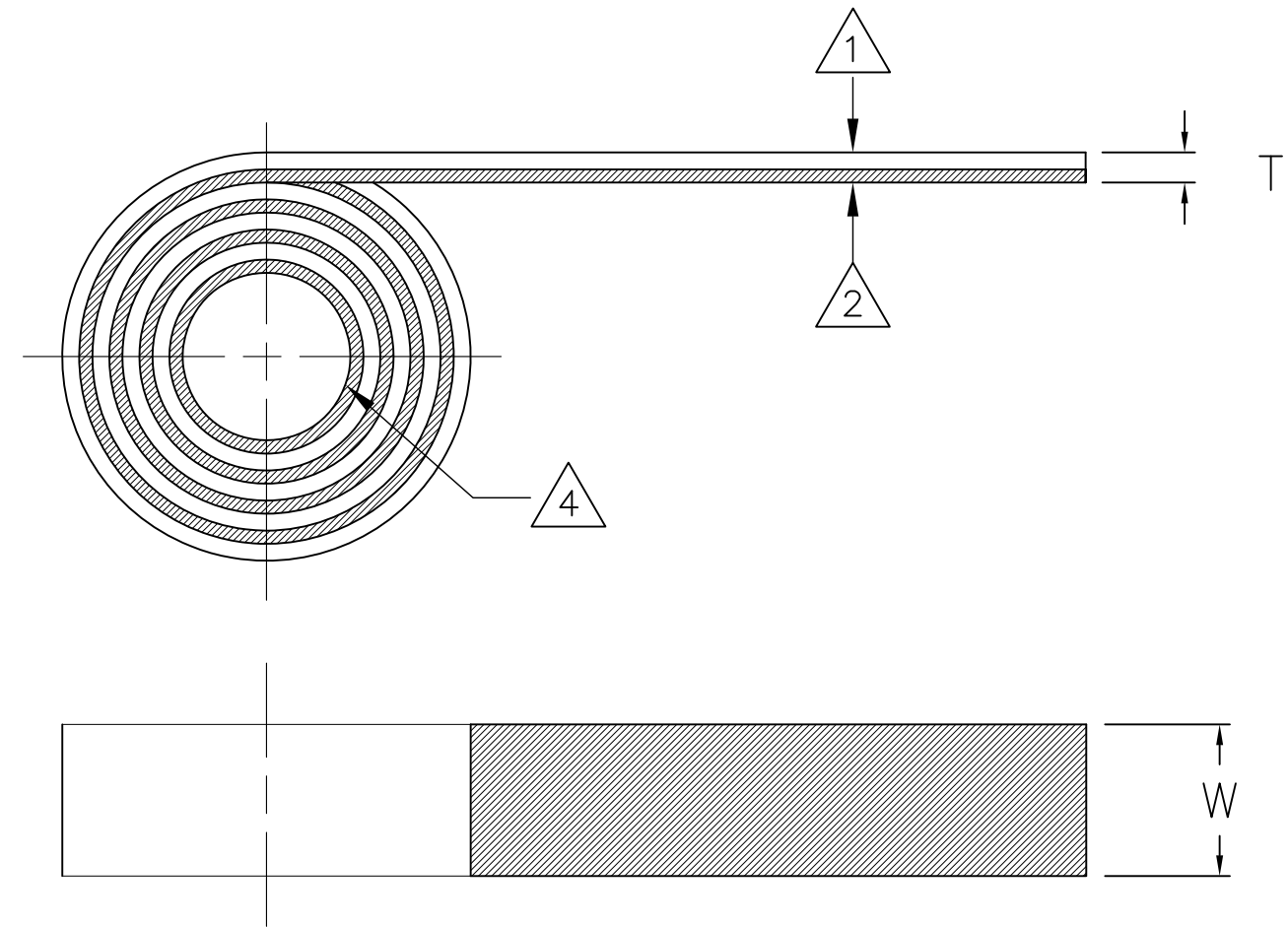

NOTES

- 1. FLUID RESISTANT, HIGH TEMPERATURE FLOUROPOLYMER
- 2. HIGH TEMPERATURE THERMOPLASTIC ADHESIVE
- 3. REFER TO RT-1381 FOR PRODUCT SPECIFICATION
- 4. TAPE SHALL BE SPOOLED ON A FIBER OR PLASTIC HUB
- 5. REFER TO TUS-41-3032 FOR INSTALLATION INSTRUCTIONS
- 6. ORDERING INFORMATION

PART DESCRIPTION	W	LENGTH FEET(MIN)	T
RT-555-T.75-A260-XX	.75 [18.75]	25,50	.016 [.41]
RT-555-T1.0-A260-XX	1.0 [25]	25,50	.016 [.41]
RT-555-T1.5-A260-XX	1.5 [38]	25,50	.016 [.41]
RT-555-T2.0-A260-XX	2.0 [51]	25,50	.016 [.41]

RT-555-T1.0-A260-XX



Raychem Molded Parts
CUSTOMER DRAWING

UNLESS OTHERWISE SPECIFIED DIMENSIONS ARE INCHES. METRIC DIMENSIONS ARE IN BRACKETS.
 DECIMAL TOLERANCES
 .XXX ± 0.005 [0.13 mm]
 .XX ± 0.01 [0.25 mm]
 .X ± 0.1 [0.50 mm]
 ANGLE TOLERANCE
 .X ± 1 DEG.

DRAWN
UNGUYEN
 APPROVED
DHURRELL

TE TE Connectivity

TITLE
HIGH TEMPERATURE HEAT SHRINK TAPE

THIRD ANGLE PROJECTION



SIZE B CODE IDENT. NO. 06090 DWG. NO. RT-555-TX.X-A260-XX

If this document is printed it becomes uncontrolled. Check for the latest revision

Mouser Electronics

Authorized Distributor

Click to View Pricing, Inventory, Delivery & Lifecycle Information:

[TE Connectivity:](#)

[RT-555-T1.0-A260-50](#)