

THIS DOCUMENT IS THE PROPERTY OF  
KEYSTONE ELECTRONICS CORP. AND  
SHALL NOT BE REPRODUCED, DISTRIBUTED  
OR USED AS A BASIS FOR MANUFACTURE  
WITHOUT PRIOR WRITTEN PERMISSION  
FROM KEYSTONE ELECTRONICS CORP.

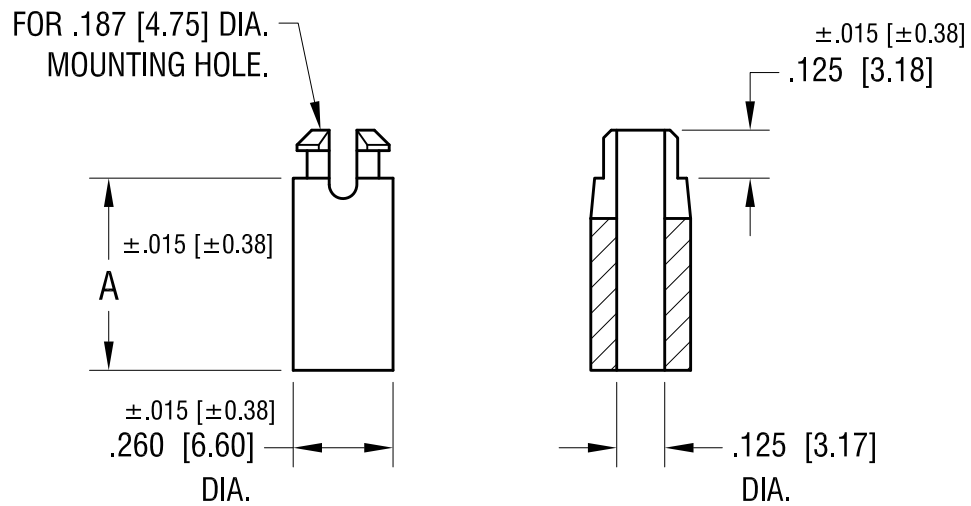

PART NO.	'A' DIM.
9027	.125 [3.18]
9028	.187 [4.75]
9029	.250 [6.35]
9030	.375 [9.53]
9031	.500 [12.70]
9032	.625 [15.88]

**KEYSTONE ELECTRONICS CORP.**

www.keyelco.com • ASTORIA, N.Y. 11105-2017 • Tel (718) 956-8900

PART NAME		THRU HOLE SPACER	
MATERIAL		NYLON UL 94V-0	
FINISH	-	DRN BY	BOONE
		DATE	8.29.06
		APP'D	SCALE
			2X
TOLERANCES	INCH [MM]	CODE	DWG NO.
DECIMAL	± .005 [± 0.13]	C/M	9027-9032
ANGULAR	± 1°		
UNLESS OTHERWISE SPECIFIED			

11.04.09	CHANGE AS PER ECN 09-160	A
DATE	DESCRIPTION	REV.

# Mouser Electronics

Authorized Distributor

Click to View Pricing, Inventory, Delivery & Lifecycle Information:

[Keystone Electronics:](#)

[9031](#)