

N- and P-Channel 100 V (D-S) MOSFET

PRODUCT SUMMARY				
	V _{DS} (V)	R _{DS(on)} (Ω) MAX.	I _D (A) ^a	Q _g (TYP.)
N-Channel	100	0.057 at V _{GS} = 10 V	5.6	4
		0.072 at V _{GS} = 4.5 V	5	
P-Channel	-100	0.183 at V _{GS} = -10 V	-3.4	11.6
		0.205 at V _{GS} = -4.5 V	-3.2	

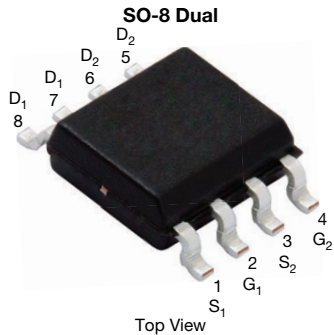

Ordering Information:

Si4590DY-T1-GE3 (Lead (Pb)-free and Halogen-free)

FEATURES

- TrenchFET® Power MOSFET
- 100 % R_g and UIS tested
- Material categorization:
For definitions of compliance please see www.vishay.com/doc?99912

RoHS
 COMPLIANT
 HALOGEN
FREE

APPLICATIONS

- H bridge / DC-AC inverter
- Brushless DC motors

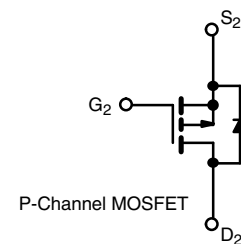
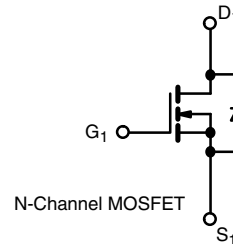

ABSOLUTE MAXIMUM RATINGS (T _A = 25 °C, unless otherwise noted)					
PARAMETER	SYMBOL	N-CHANNEL	P-CHANNEL	UNIT	
Drain-Source Voltage	V _{DS}	100	-100	V	
Gate-Source Voltage	V _{GS}	± 20			
Continuous Drain Current (T _J = 150 °C)	I _D	T _F = 25 °C	5.6	-3.4	
		T _F = 70 °C	4.5	-2.7	
		T _A = 25 °C	4.5 ^{b,c}	-2.5 ^{b,c}	
		T _A = 70 °C	3.6 ^{b,c}	-2 ^{b,c}	
Pulsed Drain Current (100 μs Pulse Width)	I _{DM}	30	-20	A	
Source-Drain Current Diode Current	I _S	T _F = 25 °C	3		-3.5
		T _A = 25 °C	2 ^{b,c}	-1.9 ^{b,c}	
Pulsed Source-Drain Current (100 μs Pulse Width)	I _{SM}	30	-20	mJ	
Single Pulse Avalanche Current	I _{AS}	5	-20		
Single Pulse Avalanche Energy	E _{AS}	1.3	20	W	
Maximum Power Dissipation	P _D	T _F = 25 °C	3.6		4.2
		T _F = 70 °C	2.3		2.7
		T _A = 25 °C	2.3 ^{b,c}		2.3 ^{b,c}
		T _A = 70 °C	1.5 ^{b,c}	1.5 ^{b,c}	
Operating Junction and Storage Temperature Range	T _J , T _{stg}	-55 to 150		°C	

THERMAL RESISTANCE RATINGS							
PARAMETER	SYMBOL	N-CHANNEL		P-CHANNEL		UNIT	
		TYP.	MAX.	TYP.	MAX.		
Maximum Junction-to-Ambient ^{b,d}	t ≤ 10 s	R _{thJA}	35	55	33	55	°C/W
Maximum Junction-to-Foot (Drain)	Steady State	R _{thJF}	20	35	17	30	

Notes

- Based on T_F = 25 °C.
- Surface mounted on 1" x 1" FR4 board.
- t = 10 s.
- Maximum under steady state conditions is 90 °C/W (n-channel) and 90 °C/W (p-channel).



SPECIFICATIONS (T _J = 25 °C, unless otherwise noted)							
PARAMETER	SYMBOL	TEST CONDITIONS	MIN.	TYP.	MAX.	UNIT	
Static							
Drain-Source Breakdown Voltage	V _{DS}	V _{GS} = 0 V, I _D = 250 μA	N-Ch	100	-	-	V
		V _{GS} = 0 V, I _D = -250 μA	P-Ch	-100	-	-	
V _{DS} Temperature Coefficient	ΔV _{DS} /T _J	I _D = 250 μA	N-Ch	-	70	-	mV/°C
		I _D = -250 μA	P-Ch	-	-103	-	
V _{GS(th)} Temperature Coefficient	ΔV _{GS(th)} /T _J	I _D = 250 μA	N-Ch	-	-5.7	-	mV/°C
		I _D = -250 μA	P-Ch	-	4.5	-	
Gate Threshold Voltage	V _{GS(th)}	V _{DS} = V _{GS} , I _D = 250 μA	N-Ch	1.5	-	2.5	V
		V _{DS} = V _{GS} , I _D = -250 μA	P-Ch	-1.5	-	-2.5	
Gate-Body Leakage	I _{GSS}	V _{DS} = 0 V, V _{GS} = ± 20 V	N-Ch	-	-	100	nA
			P-Ch	-	-	-100	
Zero Gate Voltage Drain Current	I _{DSS}	V _{DS} = 100 V, V _{GS} = 0 V	N-Ch	-	-	1	μA
		V _{DS} = -100 V, V _{GS} = 0 V	P-Ch	-	-	-1	
		V _{DS} = 100 V, V _{GS} = 0 V, T _J = 55 °C	N-Ch	-	-	10	
		V _{DS} = -100 V, V _{GS} = 0 V, T _J = 55 °C	P-Ch	-	-	-10	
On-State Drain Current ^b	I _{D(on)}	V _{DS} = 5 V, V _{GS} = 10 V	N-Ch	10	-	-	A
		V _{DS} = -5 V, V _{GS} = -10 V	P-Ch	-10	-	-	
Drain-Source On-State Resistance ^b	R _{DS(on)}	V _{GS} = 10 V, I _D = 2 A	N-Ch	-	0.047	0.057	Ω
		V _{GS} = -10 V, I _D = -2 A	P-Ch	-	0.150	0.183	
		V _{GS} = 4.5 V, I _D = 1.5 A	N-Ch	-	0.059	0.072	
		V _{GS} = -4.5 V, I _D = -1 A	P-Ch	-	0.165	0.205	
Forward Transconductance ^b	g _{fs}	V _{DS} = 15 V, I _D = 2 A	N-Ch	-	9	-	S
		V _{DS} = -15 V, I _D = -2 A	P-Ch	-	9.3	-	
Dynamic ^a							
Input Capacitance	C _{iss}	N-Channel V _{DS} = 50 V, V _{GS} = 0 V, f = 1 MHz P-Channel V _{DS} = -50 V, V _{GS} = 0 V, f = 1 MHz	N-Ch	-	360	-	pF
			P-Ch	-	1150	-	
Output Capacitance	C _{oss}		N-Ch	-	130	-	
			P-Ch	-	65	-	
Reverse Transfer Capacitance	C _{rss}		N-Ch	-	20	-	
			P-Ch	-	40	-	
Total Gate Charge	Q _g	V _{DS} = 50 V, V _{GS} = 10 V, I _D = 4.5 A	N-Ch	-	7.5	11.5	nC
		V _{DS} = -50 V, V _{GS} = -10 V, I _D = -5 A	P-Ch	-	24	36	
Gate-Source Charge	Q _{gs}	N-Channel V _{DS} = 50 V, V _{GS} = 4.5 V, I _D = 4.5 A	N-Ch	-	4	6	
			P-Ch	-	11.6	18	
Gate-Drain Charge	Q _{gd}	P-Channel V _{DS} = -50 V, V _{GS} = -4.5 V, I _D = -5 A	N-Ch	-	1.2	-	
			P-Ch	-	3.8	-	
Gate Resistance	R _g	f = 1 MHz	N-Ch	0.6	3.3	6.6	Ω
			P-Ch	3	13	26	



SPECIFICATIONS (T _J = 25 °C, unless otherwise noted)							
PARAMETER	SYMBOL	TEST CONDITIONS	MIN.	TYP.	MAX.	UNIT	
Dynamic ^a							
Turn-On Delay Time	t _{d(on)}	N-Channel V _{DD} = 50 V, R _L = 13.8 Ω I _D ≅ 3.6 A, V _{GEN} = 10 V, R _g = 1 Ω P-Channel V _{DD} = -50 V, R _L = 12.5 Ω I _D ≅ -4 A, V _{GEN} = -10 V, R _g = 1 Ω	N-Ch	-	5	10	ns
			P-Ch	-	7	15	
Rise Time	t _r		N-Ch	-	11	20	
			P-Ch	-	11	20	
Turn-Off Delay Time	t _{d(off)}		N-Ch	-	12	25	
			P-Ch	-	65	130	
Fall Time	t _f		N-Ch	-	6	15	
			P-Ch	-	20	40	
Turn-On Delay Time	t _{d(on)}	N-Channel V _{DD} = 50 V, R _L = 13.8 Ω I _D ≅ 3.6 A, V _{GEN} = 4.5 V, R _g = 1 Ω P-Channel V _{DD} = -50 V, R _L = 12.5 Ω I _D ≅ -4 A, V _{GEN} = -4.5 V, R _g = 1 Ω	N-Ch	-	32	65	ns
			P-Ch	-	55	110	
Rise Time	t _r		N-Ch	-	73	150	
			P-Ch	-	80	160	
Turn-Off Delay Time	t _{d(off)}		N-Ch	-	14	30	
			P-Ch	-	42	85	
Fall Time	t _f		N-Ch	-	12	25	
			P-Ch	-	25	50	
Drain-Source Body Diode Characteristics							
Continuous Source-Drain Diode Current	I _S	T _F = 25 °C	N-Ch	-	-	3	A
			P-Ch	-	-	-3.5	
Pulse Diode Forward Current ^a	I _{SM}		N-Ch	-	-	30	A
			P-Ch	-	-	-20	
Body Diode Voltage	V _{SD}	I _S = 3.6 A	N-Ch	-	0.83	1.2	V
		I _S = -4 A	P-Ch	-	-0.8	-1.2	
Body Diode Reverse Recovery Time	t _{rr}	N-Channel I _F = 3.6 A, di/dt = 100 A/μs, T _J = 25 °C P-Channel I _F = -4 A, di/dt = -100 A/μs, T _J = 25 °C	N-Ch	-	30	60	ns
			P-Ch	-	42	85	
Body Diode Reverse Recovery Charge	Q _{rr}	N-Channel I _F = 3.6 A, di/dt = 100 A/μs, T _J = 25 °C P-Channel I _F = -4 A, di/dt = -100 A/μs, T _J = 25 °C	N-Ch	-	27	55	nC
			P-Ch	-	93	190	
Reverse Recovery Fall Time	t _a	N-Channel I _F = 3.6 A, di/dt = 100 A/μs, T _J = 25 °C P-Channel I _F = -4 A, di/dt = -100 A/μs, T _J = 25 °C	N-Ch	-	19	-	ns
			P-Ch	-	36	-	
Reverse Recovery Rise Time	t _b	N-Channel I _F = 3.6 A, di/dt = 100 A/μs, T _J = 25 °C P-Channel I _F = -4 A, di/dt = -100 A/μs, T _J = 25 °C	N-Ch	-	11	-	ns
			P-Ch	-	6	-	

Notes

- a. Guaranteed by design, not subject to production testing.
- b. Pulse test; pulse width ≤ 300 μs, duty cycle ≤ 2 %.

Stresses beyond those listed under "Absolute Maximum Ratings" may cause permanent damage to the device. These are stress ratings only, and functional operation of the device at these or any other conditions beyond those indicated in the operational sections of the specifications is not implied. Exposure to absolute maximum rating conditions for extended periods may affect device reliability.

N-CHANNEL TYPICAL CHARACTERISTICS (25 °C, unless otherwise noted)

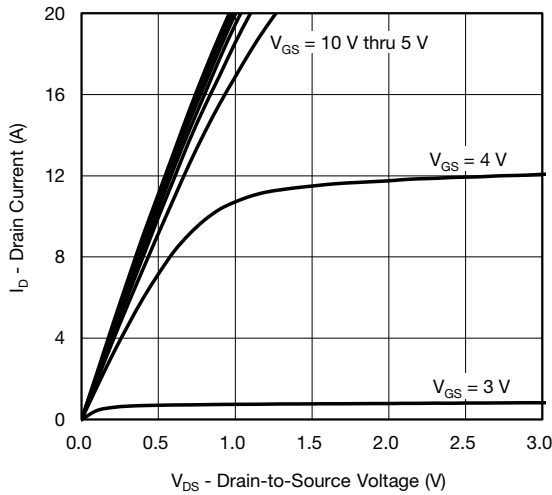

Output Characteristics

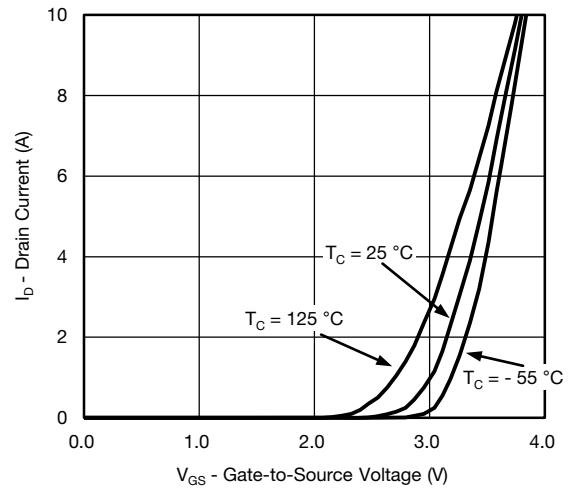

Transfer Characteristics

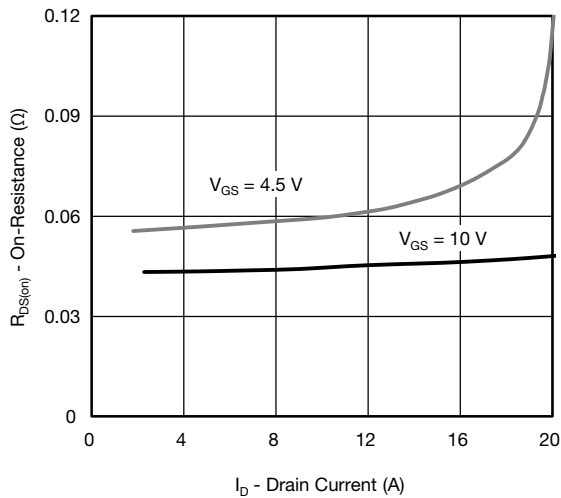

On-Resistance vs. Drain Current and Gate Voltage

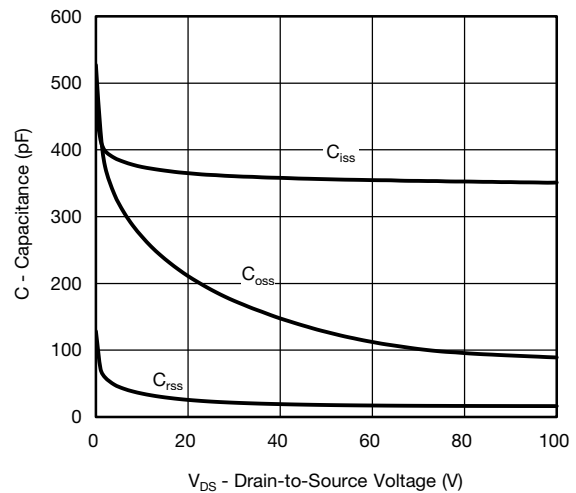

Capacitance

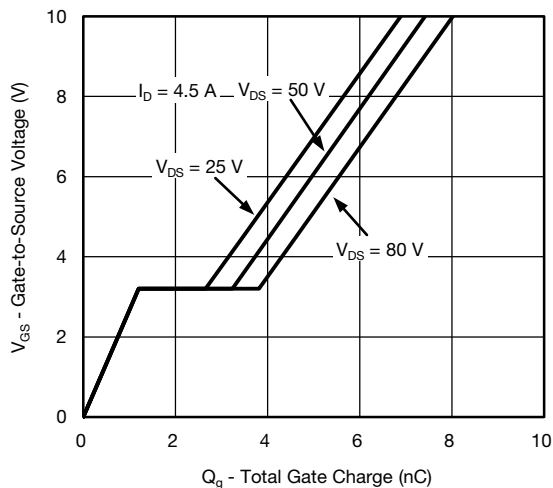

Gate Charge

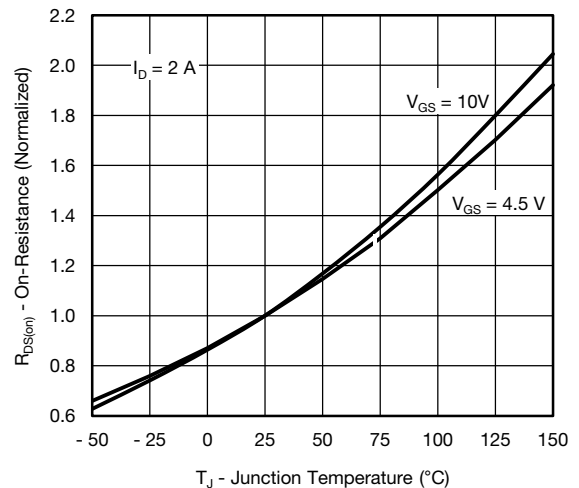

On-Resistance vs. Junction Temperature

N-CHANNEL TYPICAL CHARACTERISTICS (25 °C, unless otherwise noted)

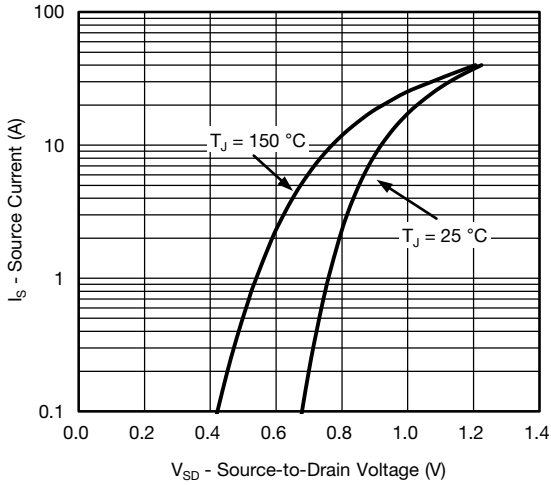

Source-Drain Diode Forward Voltage

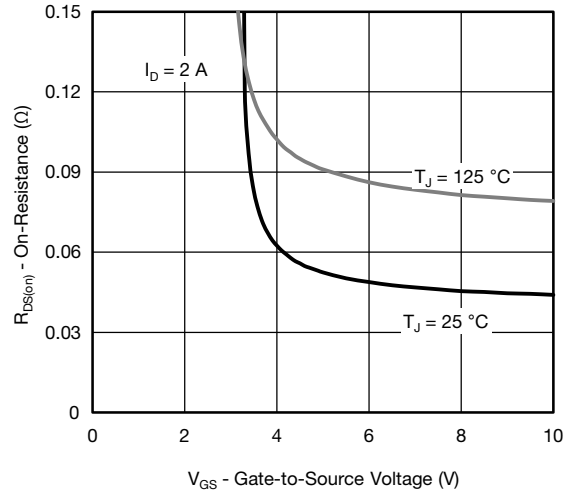

On-Resistance vs. Gate-to-Source Voltage

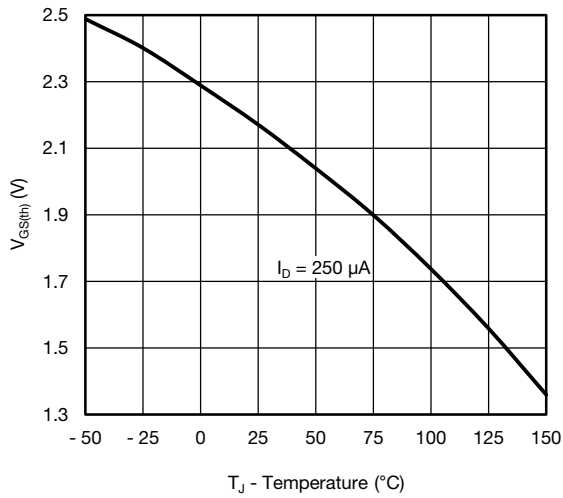

Threshold Voltage

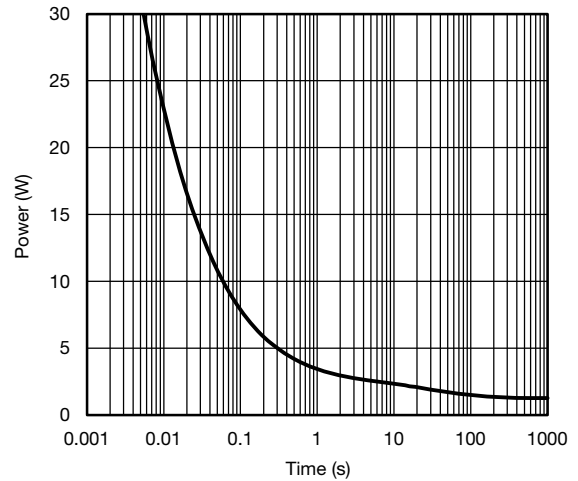

Single Pulse Power, Junction-to-Ambient

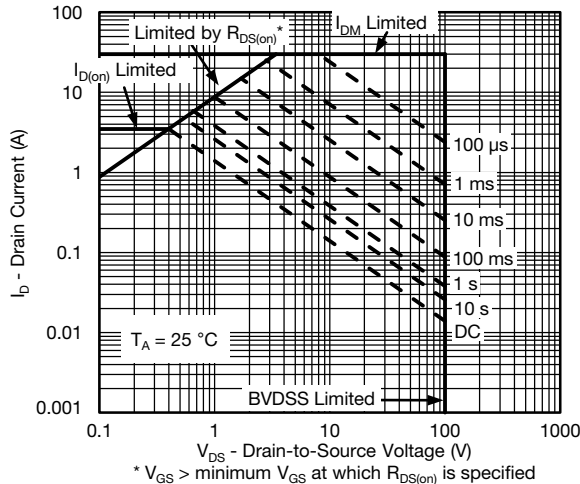

Safe Operating Area, Junction-to-Ambient



N-CHANNEL TYPICAL CHARACTERISTICS (25 °C, unless otherwise noted)

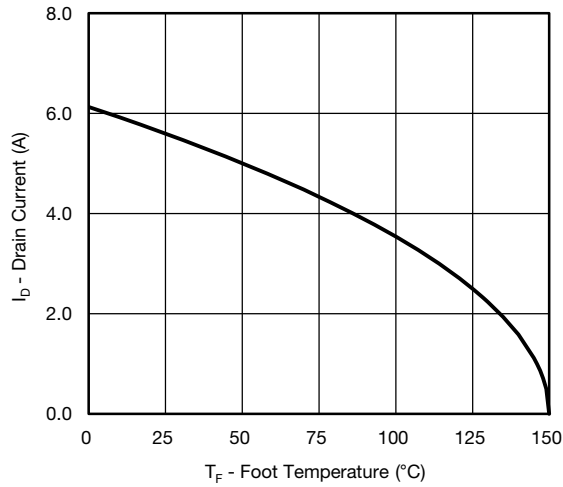

Current Derating*

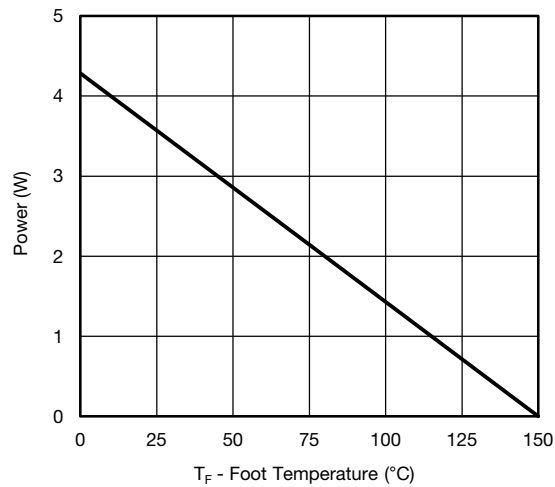

Power Derating, Junction-to-Foot

* The power dissipation P_D is based on $T_{J(max.)} = 150$ °C, using junction-to-case thermal resistance, and is more useful in settling the upper dissipation limit for cases where additional heatsinking is used. It is used to determine the current rating, when this rating falls below the package limit.



N-CHANNEL TYPICAL CHARACTERISTICS (25 °C, unless otherwise noted)

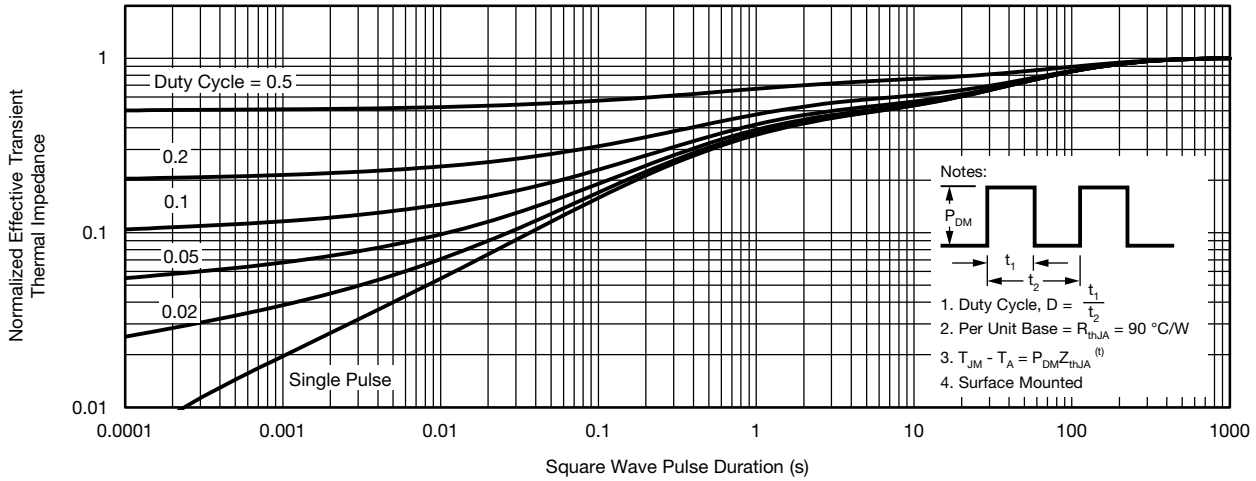

Normalized Thermal Transient Impedance, Junction-to-Ambient

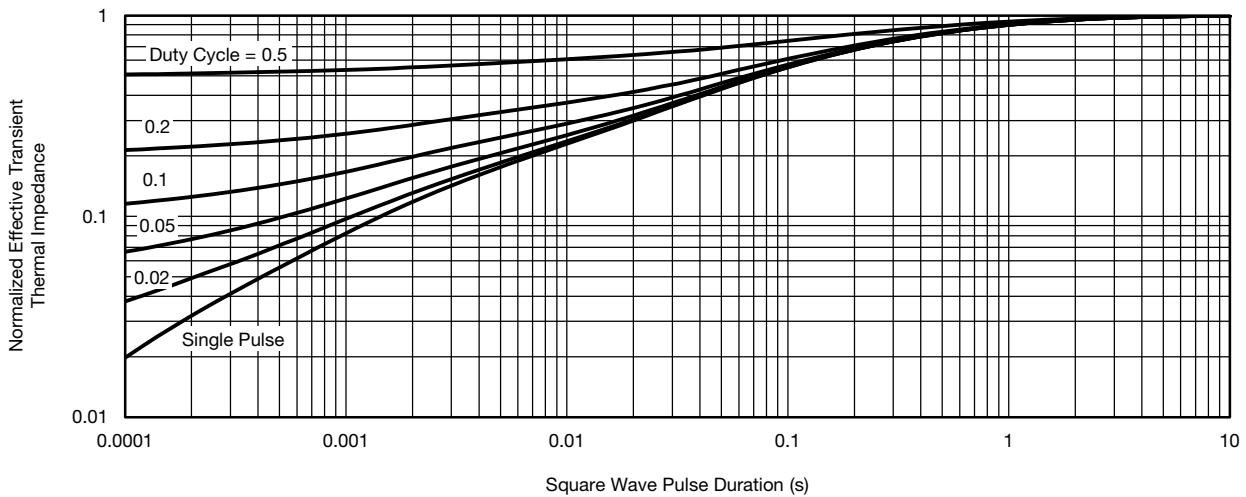

Normalized Thermal Transient Impedance, Junction-to-Foot



P-CHANNEL TYPICAL CHARACTERISTICS (25 °C, unless otherwise noted)

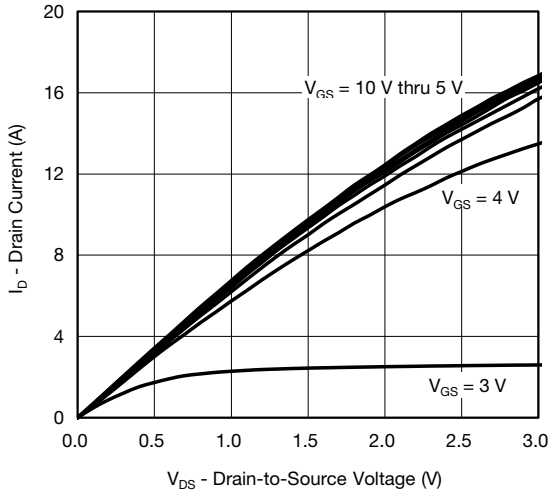

Output Characteristics

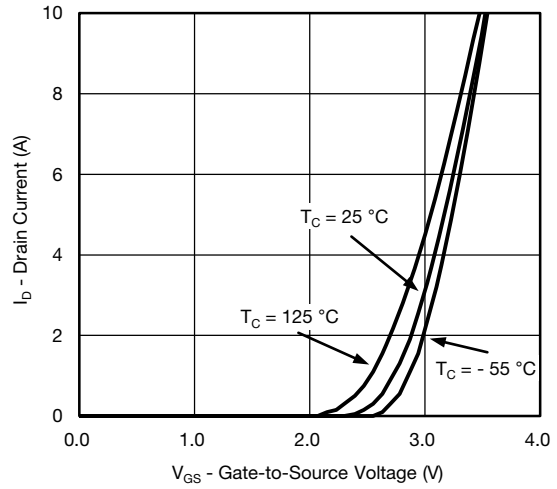

Transfer Characteristics

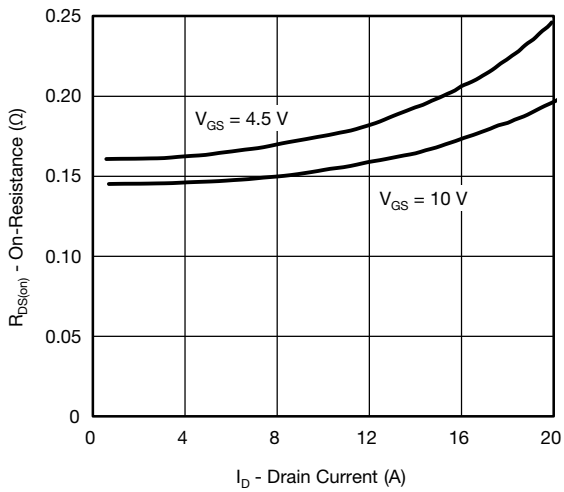

On-Resistance vs. Drain Current and Gate Voltage

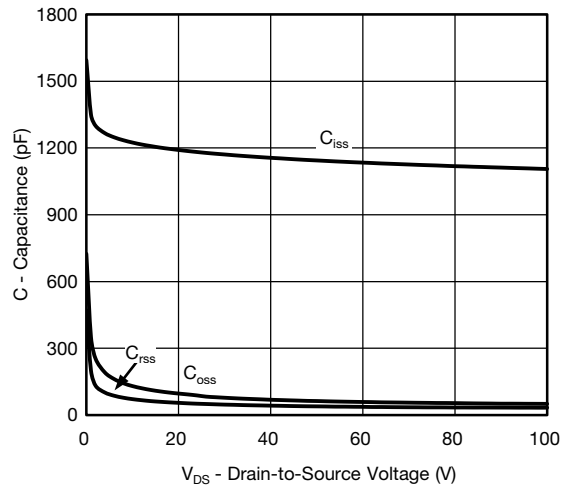

Capacitance

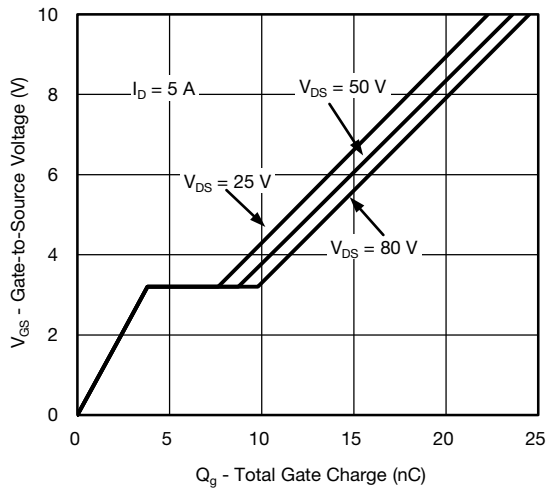

Gate Charge

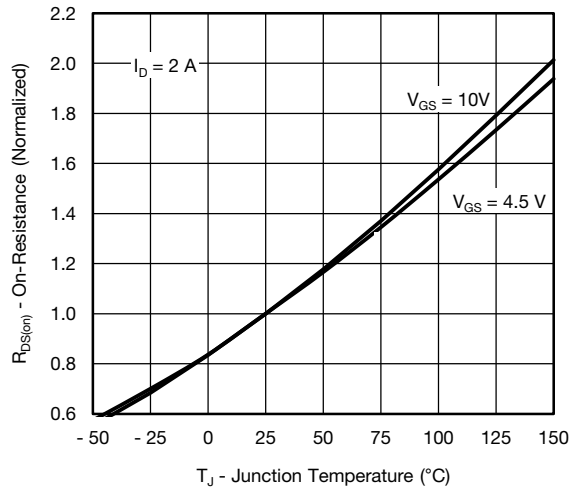

On-Resistance vs. Junction Temperature



P-CHANNEL TYPICAL CHARACTERISTICS 25 °C, (unless otherwise noted)

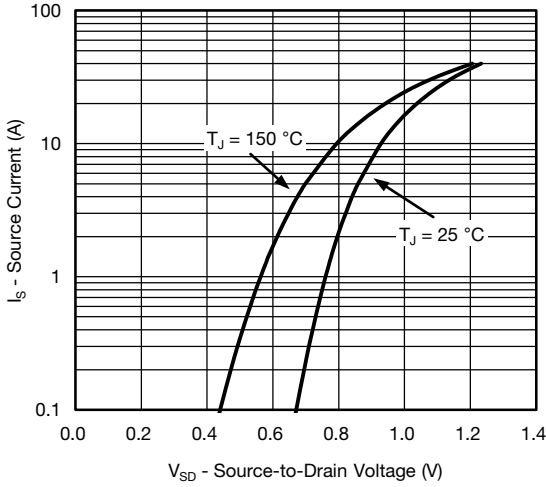

Source-Drain Diode Forward Voltage

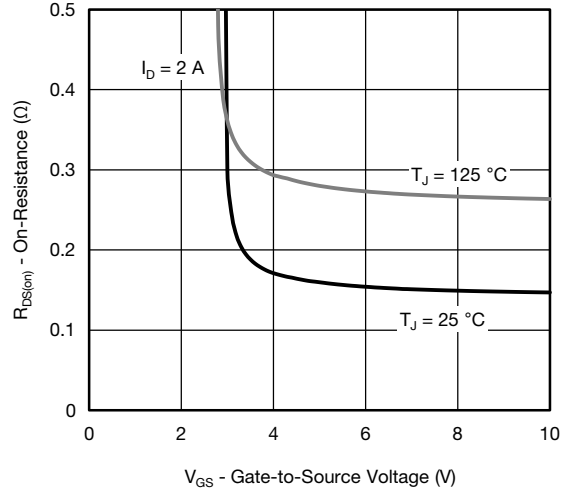

On-Resistance vs. Gate-to-Source Voltage

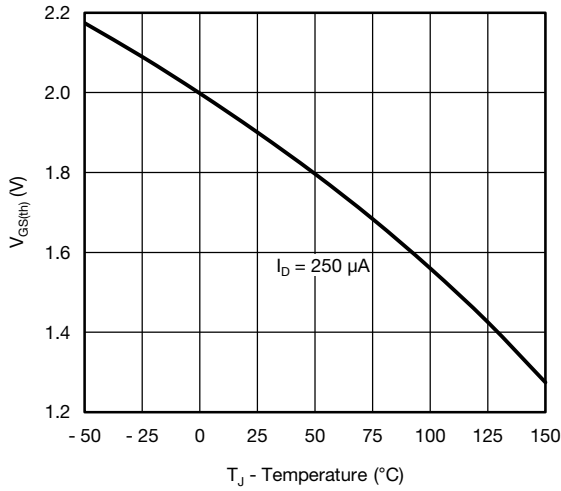

Threshold Voltage

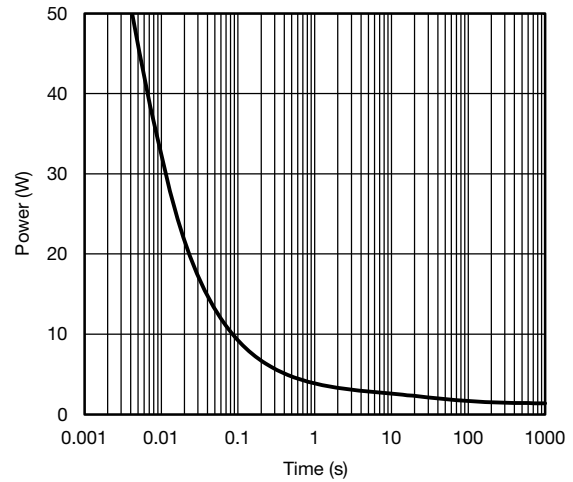

Single Pulse Power, Junction-to-Ambient

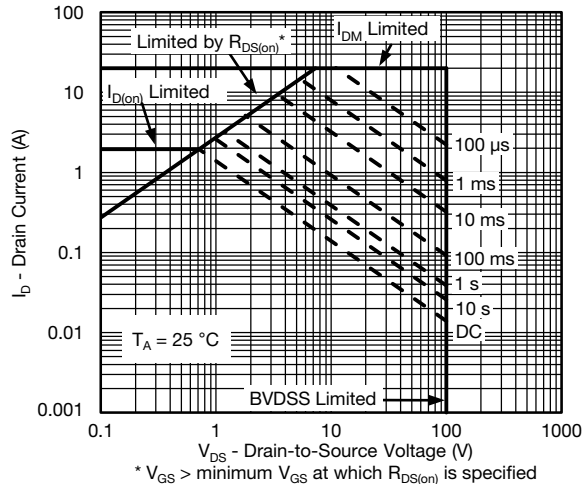

Safe Operating Area, Junction-to-Ambient



P-CHANNEL TYPICAL CHARACTERISTICS (25 °C, unless otherwise noted)

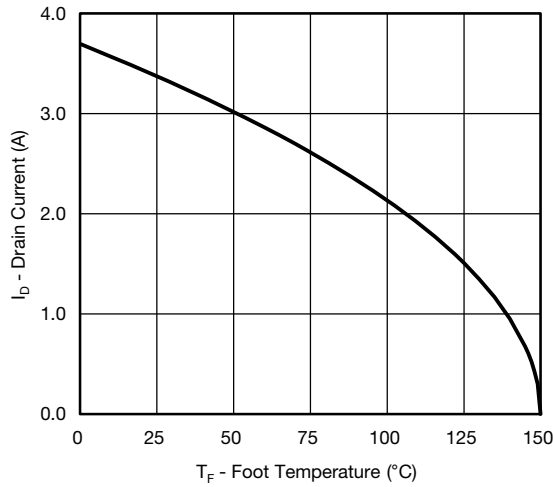

Current Derating*

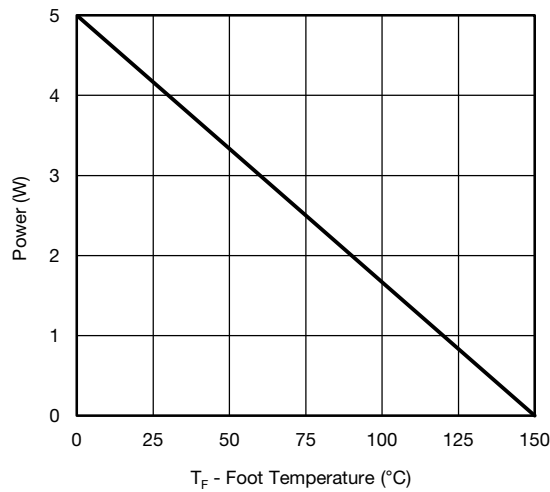

Power Derating, Junction-to-Foot

* The power dissipation P_D is based on $T_{J(max)} = 150$ °C, using junction-to-case thermal resistance, and is more useful in settling the upper dissipation limit for cases where additional heatsinking is used. It is used to determine the current rating, when this rating falls below the package limit.



P-CHANNEL TYPICAL CHARACTERISTICS (25 °C, unless otherwise noted)

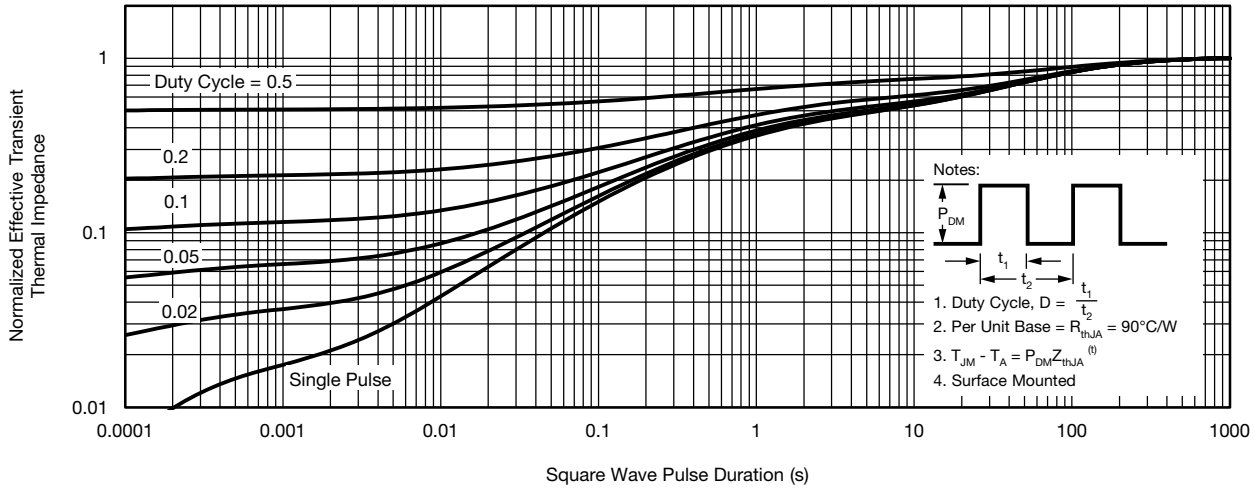

Normalized Thermal Transient Impedance, Junction-to-Ambient

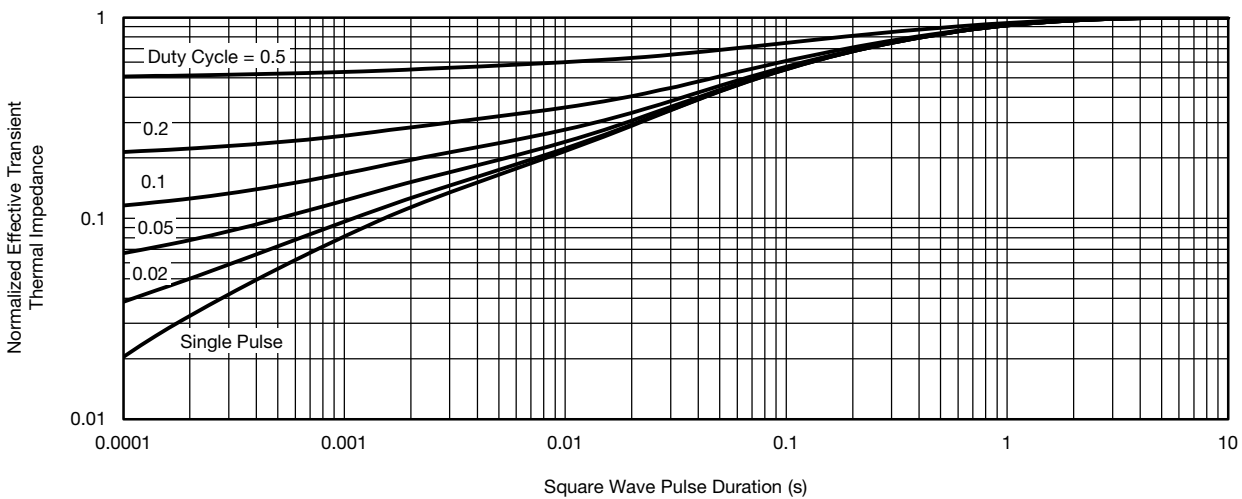

Normalized Thermal Transient Impedance, Junction-to-Foot

Vishay Siliconix maintains worldwide manufacturing capability. Products may be manufactured at one of several qualified locations. Reliability data for Silicon Technology and Package Reliability represent a composite of all qualified locations. For related documents such as package/tape drawings, part marking, and reliability data, see www.vishay.com/ppg?62937.



SOIC (NARROW): 8-LEAD

JEDEC Part Number: MS-012

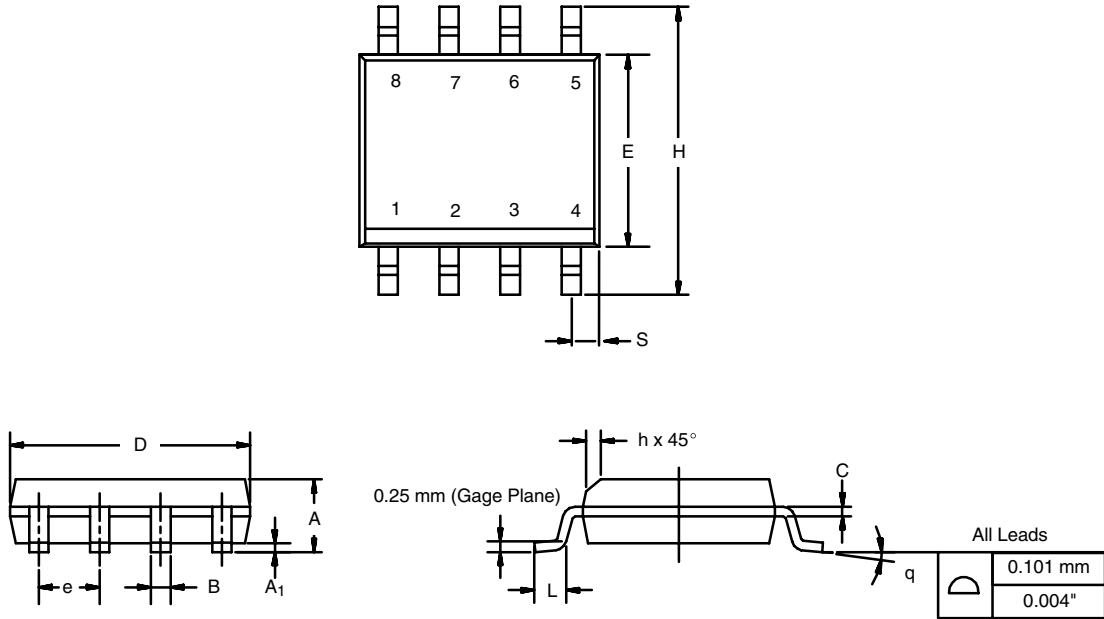

DIM	MILLIMETERS		INCHES	
	Min	Max	Min	Max
A	1.35	1.75	0.053	0.069
A ₁	0.10	0.20	0.004	0.008
B	0.35	0.51	0.014	0.020
C	0.19	0.25	0.0075	0.010
D	4.80	5.00	0.189	0.196
E	3.80	4.00	0.150	0.157
e	1.27 BSC		0.050 BSC	
H	5.80	6.20	0.228	0.244
h	0.25	0.50	0.010	0.020
L	0.50	0.93	0.020	0.037
q	0°	8°	0°	8°
S	0.44	0.64	0.018	0.026
ECN: C-06527-Rev. I, 11-Sep-06				
DWG: 5498				

RECOMMENDED MINIMUM PADS FOR SO-8



Recommended Minimum Pads
Dimensions in Inches/(mm)

[Return to Index](#)



Disclaimer

ALL PRODUCT, PRODUCT SPECIFICATIONS AND DATA ARE SUBJECT TO CHANGE WITHOUT NOTICE TO IMPROVE RELIABILITY, FUNCTION OR DESIGN OR OTHERWISE.

Vishay Intertechnology, Inc., its affiliates, agents, and employees, and all persons acting on its or their behalf (collectively, "Vishay"), disclaim any and all liability for any errors, inaccuracies or incompleteness contained in any datasheet or in any other disclosure relating to any product.

Vishay makes no warranty, representation or guarantee regarding the suitability of the products for any particular purpose or the continuing production of any product. To the maximum extent permitted by applicable law, Vishay disclaims (i) any and all liability arising out of the application or use of any product, (ii) any and all liability, including without limitation special, consequential or incidental damages, and (iii) any and all implied warranties, including warranties of fitness for particular purpose, non-infringement and merchantability.

Statements regarding the suitability of products for certain types of applications are based on Vishay's knowledge of typical requirements that are often placed on Vishay products in generic applications. Such statements are not binding statements about the suitability of products for a particular application. It is the customer's responsibility to validate that a particular product with the properties described in the product specification is suitable for use in a particular application. Parameters provided in datasheets and / or specifications may vary in different applications and performance may vary over time. All operating parameters, including typical parameters, must be validated for each customer application by the customer's technical experts. Product specifications do not expand or otherwise modify Vishay's terms and conditions of purchase, including but not limited to the warranty expressed therein.

Except as expressly indicated in writing, Vishay products are not designed for use in medical, life-saving, or life-sustaining applications or for any other application in which the failure of the Vishay product could result in personal injury or death. Customers using or selling Vishay products not expressly indicated for use in such applications do so at their own risk. Please contact authorized Vishay personnel to obtain written terms and conditions regarding products designed for such applications.

No license, express or implied, by estoppel or otherwise, to any intellectual property rights is granted by this document or by any conduct of Vishay. Product names and markings noted herein may be trademarks of their respective owners.

Mouser Electronics

Authorized Distributor

Click to View Pricing, Inventory, Delivery & Lifecycle Information:

[Vishay:](#)

[SI4590DY-T1-GE3](#)