

THIS DOCUMENT IS THE PROPERTY OF
KEYSTONE ELECTRONICS CORP. AND
SHALL NOT BE REPRODUCED, DISTRIBUTED
OR USED AS A BASIS FOR MANUFACTURE
WITHOUT PRIOR WRITTEN PERMISSION
FROM KEYSTONE ELECTRONICS CORP.

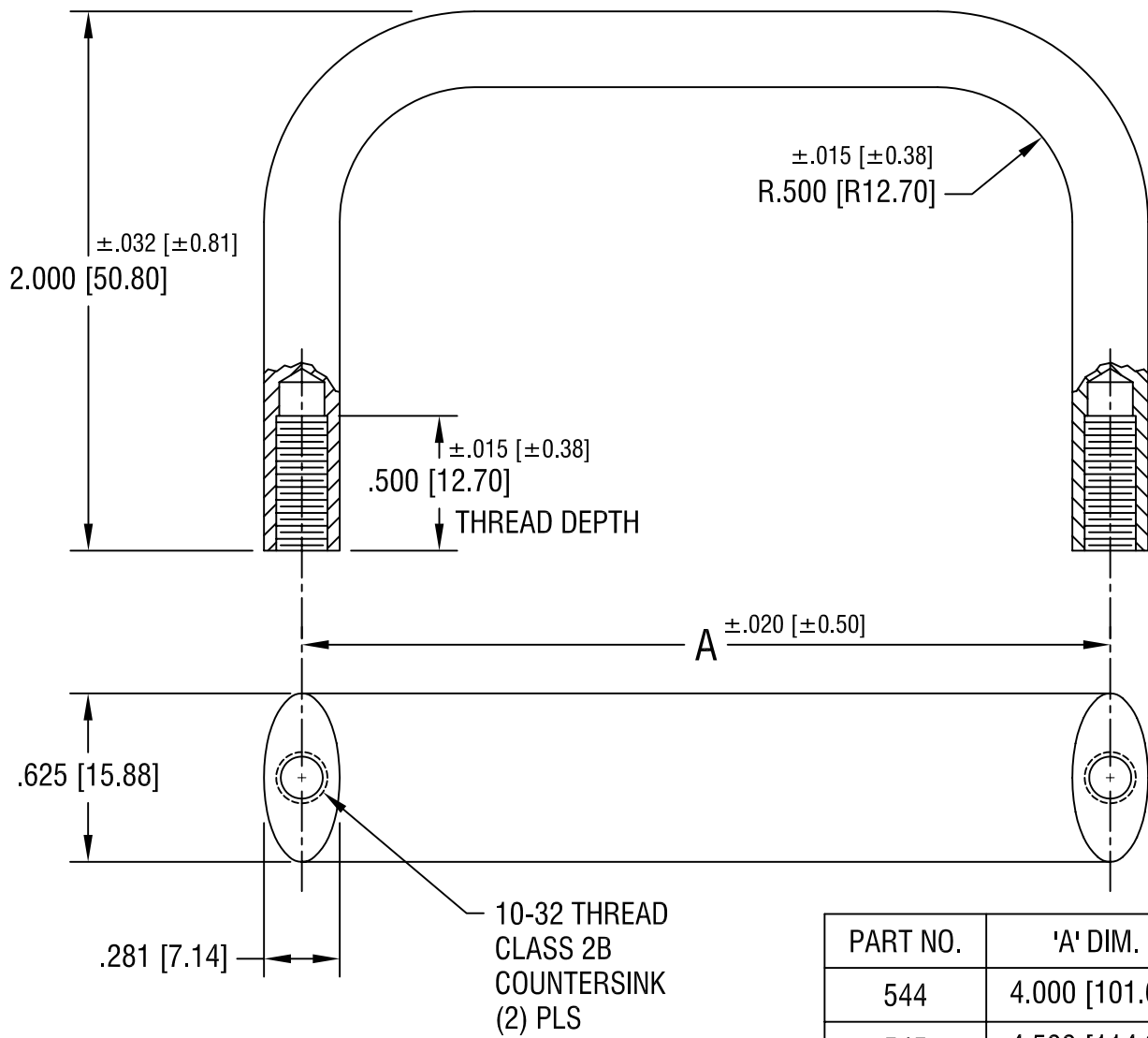

PART NO.	'A' DIM.
544	4.000 [101.60]
545	4.500 [114.30]
546	5.000 [127.00]
547	5.500 [139.70]
548	6.000 [152.40]

KEYSTONE ELECTRONICS CORP.			
ASTORIA, N.Y. 11105-2017			
PART NAME			
OVAL INSTRUMENTATION HANDLE			
MATERIAL			
ALUMINUM 6061-T6			
FINISH		DRN BY	DATE
BLACK ANODIZE		BOONE	7.12.94
		APPD	SCALE
		LN	1.5X
TOLERANCES	INCH [MM]	CODE	DWG NO.
DECIMAL	± .010 [± 0.25]	C/M	544-548
ANGULAR	± 1°		
UNLESS OTHERWISE SPECIFIED			

7.22.97	CHANGE AS PER ECR 97-030	A
DATE	DESCRIPTION	REV.

Mouser Electronics

Authorized Distributor

Click to View Pricing, Inventory, Delivery & Lifecycle Information:

[Keystone Electronics:](#)

[548](#)