



Micro Commercial Components



Micro Commercial Components
20736 Marilla Street Chatsworth
CA 91311
Phone: (818) 701-4933
Fax: (818) 701-4939

BAT54T
THRU
BAT54ST

Features

- Ultra-Small Surface Mount Package
Low Forward Voltage Drop
Halogen free available upon request by adding suffix "-HF"
PN Junction Guard Ring for Transient and ESD Protection
Epoxy meets UL 94 V-0 flammability rating
Moisture Sensitivity Level 1
Lead Free Finish/Rohs Compliant ("P" Suffix designates RoHS Compliant. See ordering information)

Table with 4 columns: MCC Part Number, Device Marking, Type, Pin Configuration. Rows include BAT54T, BAT54AT, BAT54CT, BAT54ST.

150mWatt, 30Volt
Schottky Barrier Diode

SOT-523

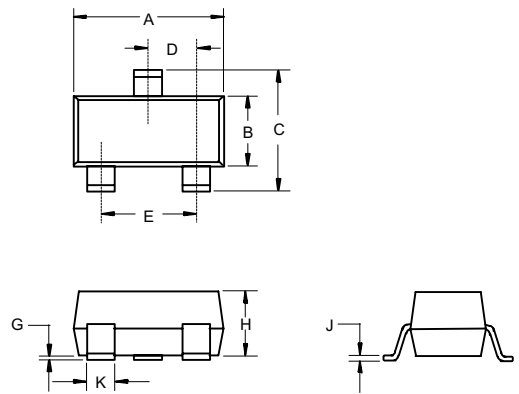

Maximum Ratings

Table with 3 columns: Parameter, Symbol, Value. Includes DC Blocking Voltage, Average Rectified Output Current, Repetitive Peak Forward Current, etc.

Electrical Characteristics @ 25°C Unless Otherwise Specified

Table with 4 columns: Ratings, Symbol, Max., Notes. Includes Forward Voltage, Reverse Current, Reverse Breakdown Voltage, Total Capacitance, Reverse Recovery Time.

DIMENSIONS table with columns: DIM, INCHES (MIN, MAX), MM (MIN, MAX), NOTE. Lists dimensions A through K.

BAT54T thru BAT54ST

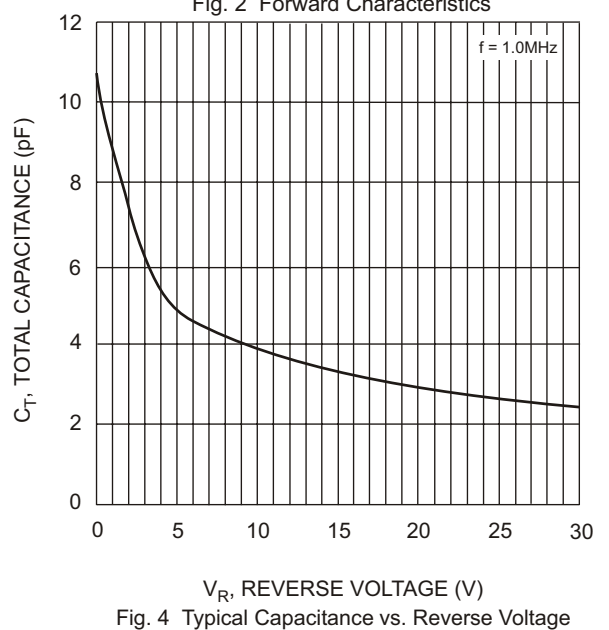
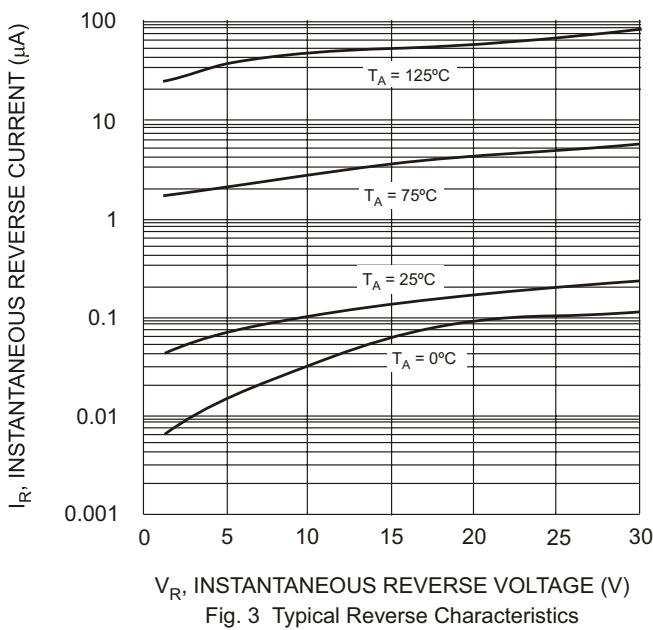
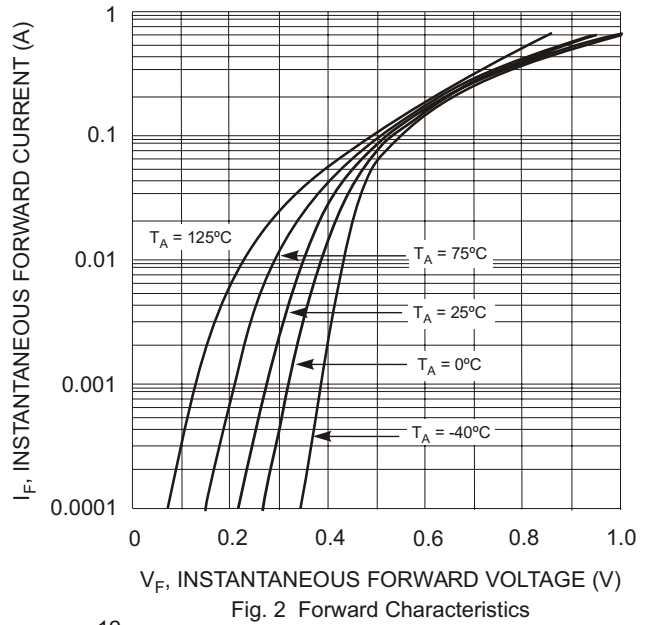
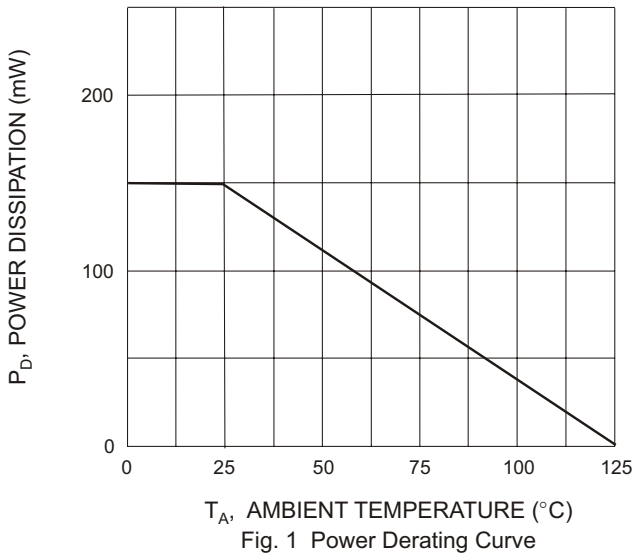

Pin Configuration - Top View

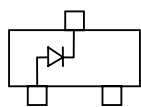

Figure 1

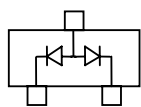

Figure 2

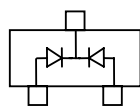

Figure 3

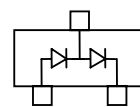

Figure 4



TM

Micro Commercial Components

Ordering Information :

Device	Packing
Part Number-TP	Tape&Reel: 3Kpcs/Reel

Note : Adding "-HF" suffix for halogen free, eg. Part Number-TP-HF

IMPORTANT NOTICE

Micro Commercial Components Corp. reserves the right to make changes without further notice to any product herein to make corrections, modifications , enhancements , improvements , or other changes . **Micro Commercial Components Corp .** does not assume any liability arising out of the application or use of any product described herein; neither does it convey any license under its patent rights ,nor the rights of others . The user of products in such applications shall assume all risks of such use and will agree to hold **Micro Commercial Components Corp .** and all the companies whose products are represented on our website, harmless against all damages.

LIFE SUPPORT

MCC's products are not authorized for use as critical components in life support devices or systems without the express written approval of Micro Commercial Components Corporation.

CUSTOMER AWARENESS

Counterfeiting of semiconductor parts is a growing problem in the industry. Micro Commercial Components (MCC) is taking strong measures to protect ourselves and our customers from the proliferation of counterfeit parts. MCC strongly encourages customers to purchase MCC parts either directly from MCC or from Authorized MCC Distributors who are listed by country on our web page cited below. Products customers buy either from MCC directly or from Authorized MCC Distributors are genuine parts, have full traceability, meet MCC's quality standards for handling and storage. **MCC will not provide any warranty coverage or other assistance for parts bought from Unauthorized Sources.** MCC is committed to combat this global problem and encourage our customers to do their part in stopping this practice by buying direct or from authorized distributors.

Mouser Electronics

Authorized Distributor

Click to View Pricing, Inventory, Delivery & Lifecycle Information:

[Micro Commercial Components \(MCC\):](#)

[BAT54AT-TP](#) [BAT54ST-TP](#) [BAT54CT-TP](#) [BAT54T-TP](#)