

# MMBF4391L, MMBF4392L, MMBF4393L

## JFET Switching Transistors

### N-Channel

#### Features

- S Prefix for Automotive and Other Applications Requiring Unique Site and Control Change Requirements; AEC-Q101 Qualified and PPAP Capable
- These Devices are Pb-Free, Halogen Free/BFR Free and are RoHS Compliant

#### MAXIMUM RATINGS

Rating	Symbol	Value	Unit
Drain-Source Voltage	$V_{DS}$	30	Vdc
Drain-Gate Voltage	$V_{DG}$	30	Vdc
Gate-Source Voltage	$V_{GS}$	30	Vdc
Forward Gate Current	$I_{G(f)}$	50	mAdc

#### THERMAL CHARACTERISTICS

Characteristic	Symbol	Max	Unit
Total Device Dissipation FR-5 Board (Note 1) $T_A = 25^\circ\text{C}$ Derate above $25^\circ\text{C}$	$P_D$	225 1.8	mW mW/ $^\circ\text{C}$
Thermal Resistance, Junction-to-Ambient	$R_{\theta JA}$	556	$^\circ\text{C}/\text{W}$
Junction and Storage Temperature Range	$T_J, T_{stg}$	-55 to +150	$^\circ\text{C}$

Stresses exceeding those listed in the Maximum Ratings table may damage the device. If any of these limits are exceeded, device functionality should not be assumed, damage may occur and reliability may be affected.

1. FR-5 =  $1.0 \times 0.75 \times 0.062$  in.



ON Semiconductor®

[www.onsemi.com](http://www.onsemi.com)

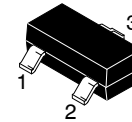

SOT-23  
CASE 318  
STYLE 10

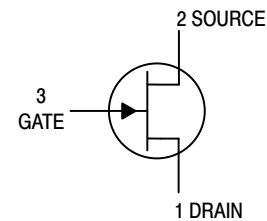

#### MARKING DIAGRAM

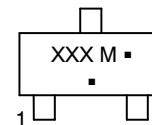

XXX = Specific Device Code  
M = Date Code\*  
▪ = Pb-Free Package

(Note: Microdot may be in either location)

\*Date Code orientation and/or overbar may vary depending upon manufacturing location.

#### MARKING & ORDERING INFORMATION

See detailed ordering, marking and shipping information in the package dimensions section on page 2 of this data sheet.

# MMBF4391L, MMBF4392L, MMBF4393L

## ELECTRICAL CHARACTERISTICS (T<sub>A</sub> = 25°C unless otherwise noted)

Characteristic	Symbol	Min	Max	Unit
<b>OFF CHARACTERISTICS</b>				
Gate–Source Breakdown Voltage (I <sub>G</sub> = 1.0 μAdc, V <sub>DS</sub> = 0)	V <sub>(BR)GSS</sub>	30	–	Vdc
Gate Reverse Current (V <sub>GS</sub> = 15 Vdc, V <sub>DS</sub> = 0, T <sub>A</sub> = 25°C) (V <sub>GS</sub> = 15 Vdc, V <sub>DS</sub> = 0, T <sub>A</sub> = 100°C)	I <sub>GSS</sub>	– –	1.0 0.20	nAdc μAdc
Gate–Source Cutoff Voltage (V <sub>DS</sub> = 15 Vdc, I <sub>D</sub> = 10 nAdc) MMBF4391LT1 MMBF4392LT1 MMBF4393LT1	V <sub>GS(off)</sub>	–4.0 –2.0 –0.5	–10 –5.0 –3.0	Vdc
Off–State Drain Current (V <sub>DS</sub> = 15 Vdc, V <sub>GS</sub> = –12 Vdc) (V <sub>DS</sub> = 15 Vdc, V <sub>GS</sub> = –12 Vdc, T <sub>A</sub> = 100°C)	I <sub>D(off)</sub>	– –	1.0 1.0	nAdc μAdc

## ON CHARACTERISTICS

Zero–Gate–Voltage Drain Current (V <sub>DS</sub> = 15 Vdc, V <sub>GS</sub> = 0) MMBF4391LT1 MMBF4392LT1 MMBF4393LT1	I <sub>DSS</sub>	50 25 5.0	150 75 30	mAdc
Drain–Source On–Voltage (I <sub>D</sub> = 12 mAdc, V <sub>GS</sub> = 0) MMBF4391LT1 (I <sub>D</sub> = 6.0 mAdc, V <sub>GS</sub> = 0) MMBF4392LT1 (I <sub>D</sub> = 3.0 mAdc, V <sub>GS</sub> = 0) MMBF4393LT1	V <sub>DS(on)</sub>	– – –	0.4 0.4 0.4	Vdc
Static Drain–Source On–Resistance (I <sub>D</sub> = 1.0 mAdc, V <sub>GS</sub> = 0) MMBF4391LT1 MMBF4392LT1 MMBF4393LT1	r <sub>DS(on)</sub>	– – –	30 60 100	Ω

## SMALL– SIGNAL CHARACTERISTICS

Input Capacitance (V <sub>DS</sub> = 0 Vdc, V <sub>GS</sub> = –15 Vdc, f = 1.0 MHz)	C <sub>iss</sub>	–	14	pF
Reverse Transfer Capacitance (V <sub>DS</sub> = 0 Vdc, V <sub>GS</sub> = –12 Vdc, f = 1.0 MHz)	C <sub>rss</sub>	–	3.5	pF

Product parametric performance is indicated in the Electrical Characteristics for the listed test conditions, unless otherwise noted. Product performance may not be indicated by the Electrical Characteristics if operated under different conditions.

## ORDERING INFORMATION

Device	Marking	Package	Shipping <sup>†</sup>
MMBF4391LT1G	6J	SOT–23 (Pb–Free)	3,000 / Tape & Reel
SMMBF4391LT1G*	6J		
MMBF4392LT1G	6K		
MMBF4393LT1G	M6G		
SMMBF4393LT1G*	M6G		

<sup>†</sup>For information on tape and reel specifications, including part orientation and tape sizes, please refer to our Tape and Reel Packaging Specifications Brochure, BRD8011/D.

# MMBF4391L, MMBF4392L, MMBF4393L

## TYPICAL CHARACTERISTICS

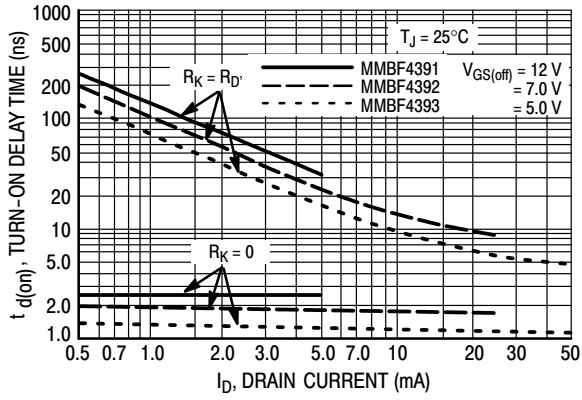

Figure 1. Turn-On Delay Time

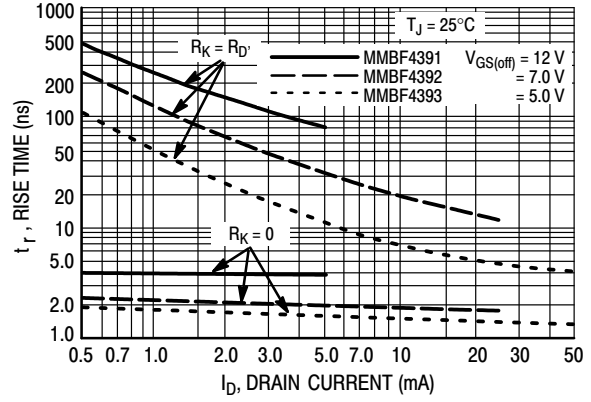

Figure 2. Rise Time

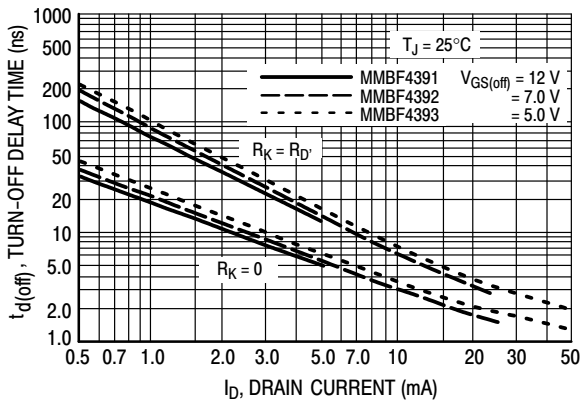

Figure 3. Turn-Off Delay Time

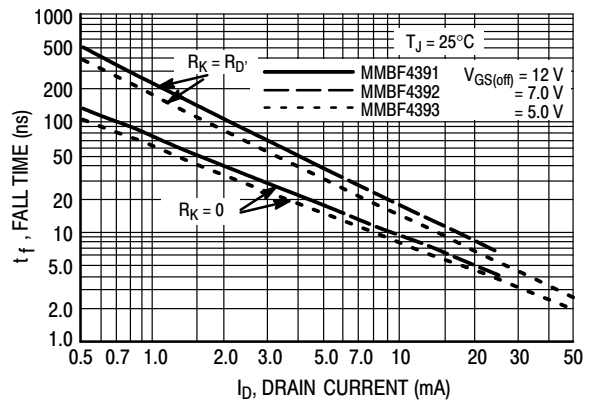

Figure 4. Fall Time

NOTE 1

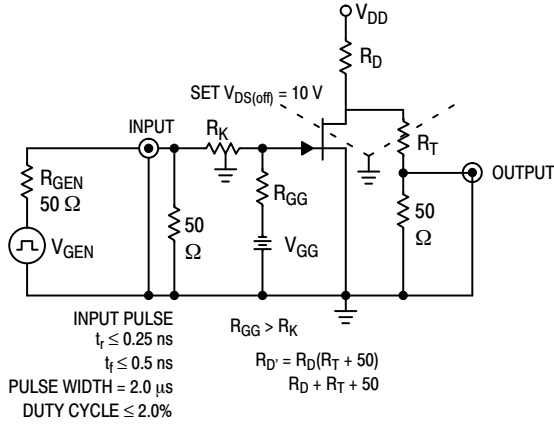

Figure 5. Switching Time Test Circuit

The switching characteristics shown above were measured using a test circuit similar to Figure 5. At the beginning of the switching interval, the gate voltage is at Gate Supply Voltage ( $-V_{GG}$ ). The Drain-Source Voltage ( $V_{DS}$ ) is slightly lower than Drain Supply Voltage ( $V_{DD}$ ) due to the voltage divider. Thus Reverse Transfer Capacitance ( $C_{rss}$ ) of Gate-Drain Capacitance ( $C_{gd}$ ) is charged to  $V_{GG} + V_{DS}$ .

During the turn-on interval, Gate-Source Capacitance ( $C_{gs}$ ) discharges through the series combination of  $R_{Gen}$  and  $R_K$ .  $C_{gd}$  must discharge to  $V_{DS(on)}$  through  $R_G$  and  $R_K$  in series with the parallel combination of effective load impedance ( $R'_D$ ) and Drain-Source Resistance ( $r_{DS}$ ). During the turn-off, this charge flow is reversed.

Predicting turn-on time is somewhat difficult as the channel resistance  $r_{DS}$  is a function of the gate-source voltage. While  $C_{gs}$  discharges,  $V_{GS}$  approaches zero and  $r_{DS}$  decreases. Since  $C_{gd}$  discharges through  $r_{DS}$ , turn-on time is non-linear. During turn-off, the situation is reversed with  $r_{DS}$  increasing as  $C_{gd}$  charges.

The above switching curves show two impedance conditions; 1)  $R_K$  is equal to  $R_D$ , which simulates the switching behavior of cascaded stages where the driving source impedance is normally the load impedance of the previous stage, and 2)  $R_K = 0$  (low impedance) the driving source impedance is that of the generator.

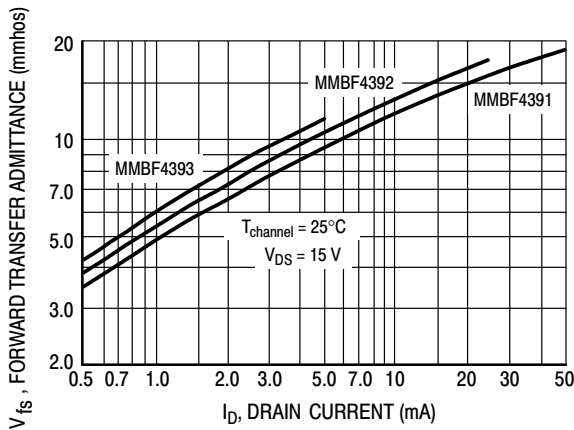

Figure 6. Typical Forward Transfer Admittance

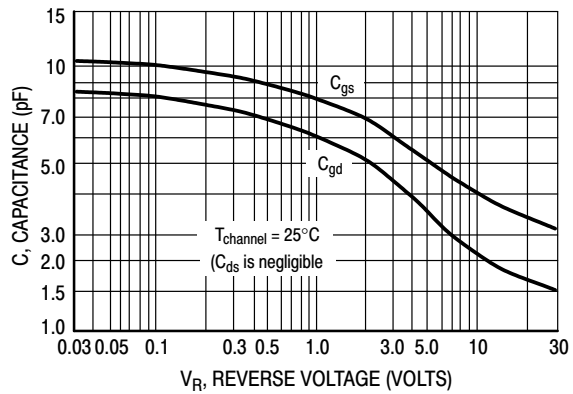

Figure 7. Typical Capacitance

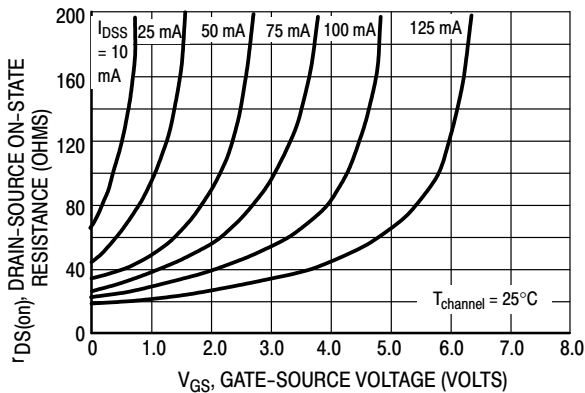

Figure 8. Effect of Gate-Source Voltage on Drain-Source Resistance

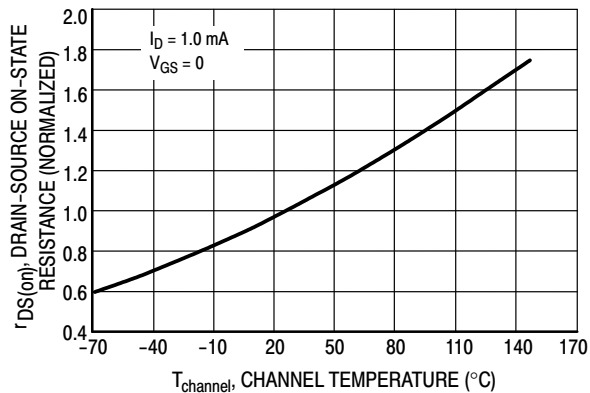
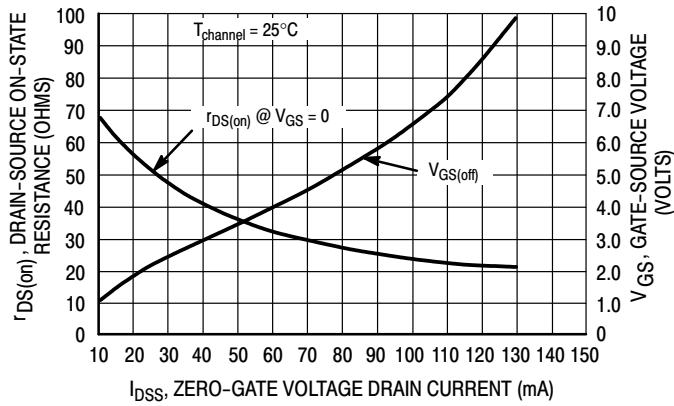

Figure 9. Effect of Temperature on Drain-Source On-State Resistance

# MMBF4391L, MMBF4392L, MMBF4393L



**Figure 10. Effect of  $I_{DSS}$  on Drain-Source Resistance and Gate-Source Voltage**

## NOTE 2

The Zero-Gate-Voltage Drain Current ( $I_{DSS}$ ) is the principle determinant of other J-FET characteristics. Figure 10 shows the relationship of Gate-Source Off Voltage ( $V_{GS(off)}$ ) and Drain-Source On Resistance ( $r_{DS(on)}$ ) to  $I_{DSS}$ . Most of the devices will be within  $\pm 10\%$  of the values shown in Figure 10. This data will be useful in predicting the characteristic variations for a given part number.

For example:

Unknown

$r_{DS(on)}$  and  $V_{GS}$  range for an MMBF4392

The electrical characteristics table indicates that an MMBF4392 has an  $I_{DSS}$  range of 25 to 75 mA. Figure 10 shows  $r_{DS(on)} = 52 \Omega$  for  $I_{DSS} = 25$  mA and  $30 \Omega$  for  $I_{DSS} = 75$  mA. The corresponding  $V_{GS}$  values are 2.2 V and 4.8 V.

# MMBF4391L, MMBF4392L, MMBF4393L

## PACKAGE DIMENSIONS

SOT-23 (TO-236)  
CASE 318-08  
ISSUE AR

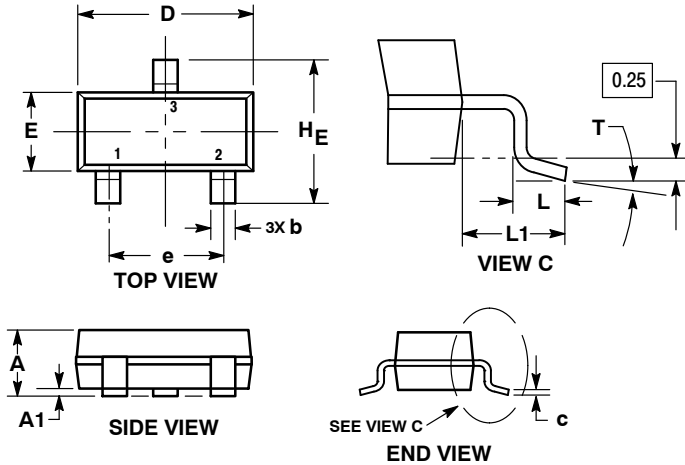

NOTES:

1. DIMENSIONING AND TOLERANCING PER ASME Y14.5M, 1994.
2. CONTROLLING DIMENSION: MILLIMETERS.
3. MAXIMUM LEAD THICKNESS INCLUDES LEAD FINISH. MINIMUM LEAD THICKNESS IS THE MINIMUM THICKNESS OF THE BASE MATERIAL.
4. DIMENSIONS D AND E DO NOT INCLUDE MOLD FLASH, PROTRUSIONS, OR GATE BURRS.

DIM	MILLIMETERS			INCHES		
	MIN	NOM	MAX	MIN	NOM	MAX
A	0.89	1.00	1.11	0.035	0.039	0.044
A1	0.01	0.06	0.10	0.000	0.002	0.004
b	0.37	0.44	0.50	0.015	0.017	0.020
c	0.08	0.14	0.20	0.003	0.006	0.008
D	2.80	2.90	3.04	0.110	0.114	0.120
E	1.20	1.30	1.40	0.047	0.051	0.055
e	1.78	1.90	2.04	0.070	0.075	0.080
L	0.30	0.43	0.55	0.012	0.017	0.022
L1	0.35	0.54	0.69	0.014	0.021	0.027
HE	2.10	2.40	2.64	0.083	0.094	0.104
T	0°	---	10°	0°	---	10°

- STYLE 10:  
PIN 1: DRAIN  
2: SOURCE  
3: GATE

### RECOMMENDED SOLDERING FOOTPRINT\*

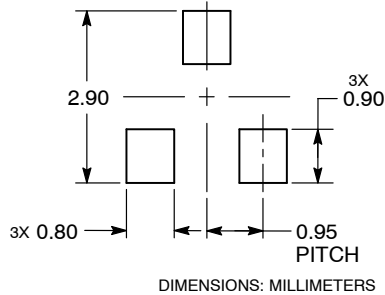

\*For additional information on our Pb-Free strategy and soldering details, please download the ON Semiconductor Soldering and Mounting Techniques Reference Manual, SOLDERRM/D.

ON Semiconductor and are trademarks of Semiconductor Components Industries, LLC dba ON Semiconductor or its subsidiaries in the United States and/or other countries. ON Semiconductor owns the rights to a number of patents, trademarks, copyrights, trade secrets, and other intellectual property. A listing of ON Semiconductor's product/patent coverage may be accessed at [www.onsemi.com/site/pdf/Patent-Marking.pdf](http://www.onsemi.com/site/pdf/Patent-Marking.pdf). ON Semiconductor reserves the right to make changes without further notice to any products herein. ON Semiconductor makes no warranty, representation or guarantee regarding the suitability of its products for any particular purpose, nor does ON Semiconductor assume any liability arising out of the application or use of any product or circuit, and specifically disclaims any and all liability, including without limitation special, consequential or incidental damages. Buyer is responsible for its products and applications using ON Semiconductor products, including compliance with all laws, regulations and safety requirements or standards, regardless of any support or applications information provided by ON Semiconductor. "Typical" parameters which may be provided in ON Semiconductor data sheets and/or specifications can and do vary in different applications and actual performance may vary over time. All operating parameters, including "Typicals" must be validated for each customer application by customer's technical experts. ON Semiconductor does not convey any license under its patent rights nor the rights of others. ON Semiconductor products are not designed, intended, or authorized for use as a critical component in life support systems or any FDA Class 3 medical devices or medical devices with a same or similar classification in a foreign jurisdiction or any devices intended for implantation in the human body. Should Buyer purchase or use ON Semiconductor products for any such unintended or unauthorized application, Buyer shall indemnify and hold ON Semiconductor and its officers, employees, subsidiaries, affiliates, and distributors harmless against all claims, costs, damages, and expenses, and reasonable attorney fees arising out of, directly or indirectly, any claim of personal injury or death associated with such unintended or unauthorized use, even if such claim alleges that ON Semiconductor was negligent regarding the design or manufacture of the part. ON Semiconductor is an Equal Opportunity/Affirmative Action Employer. This literature is subject to all applicable copyright laws and is not for resale in any manner.

### PUBLICATION ORDERING INFORMATION

**LITERATURE FULFILLMENT:**  
Literature Distribution Center for ON Semiconductor  
P.O. Box 5163, Denver, Colorado 80217 USA  
**Phone:** 303-675-2175 or 800-344-3860 Toll Free USA/Canada  
**Fax:** 303-675-2176 or 800-344-3867 Toll Free USA/Canada  
**Email:** [orderlit@onsemi.com](mailto:orderlit@onsemi.com)

**N. American Technical Support:** 800-282-9855 Toll Free  
USA/Canada  
**Europe, Middle East and Africa Technical Support:**  
Phone: 421 33 790 2910  
**Japan Customer Focus Center**  
Phone: 81-3-5817-1050

**ON Semiconductor Website:** [www.onsemi.com](http://www.onsemi.com)  
**Order Literature:** <http://www.onsemi.com/orderlit>

For additional information, please contact your local Sales Representative

# Mouser Electronics

Authorized Distributor

Click to View Pricing, Inventory, Delivery & Lifecycle Information:

[ON Semiconductor:](#)

[MMBF4391LT1G](#) [MMBF4392LT1G](#) [MMBF4393LT1G](#) [MMBF4393LT3G](#)