

High capacity SSR  
up to 40A  
with wide variation

## AQ-N RELAYS



### FEATURES

1. Five types available from 10A to 40A
2. Built-in varistor
3. Includes operation LED (red)
4. Dielectric voltage of 4,000V
5. 4 to 32V DC input voltage
6. Both zero-cross and random types available

### TYPICAL APPLICATIONS

1. Molding machine (heater control)
2. Temperature controlled bath (heater control)
3. Printing machines (heater control)
4. Wrapping and packing machine (heater control)
5. Machine tools (Motor control)

Compliance with RoHS Directive

## ORDERING INFORMATION

<b>A</b>	<b>Q</b>	<b>N</b>				
AQ-N Solid State Relays						
Load current						
1: 10 A						
2: 15 A						
3: 20 A						
4: 25 A						
6: 40 A						
Load voltage						
1: 75 to 250 V AC, Zero-cross						
2: 75 to 250 V AC, Random						
Input voltage						
1: 4 to 32 V DC						
Function						
Nil: None						
V: Built-in varistor						
L: With LED indication						
VL: Built-in varistor and with LED indication						

## TYPES

### 1. Standard type

Type	Load current	Load voltage	Part No.
Zero-cross type	10A	75 to 250V AC	AQN111
	15A		AQN211
	20A		AQN311
	25A		AQN411
	40A		AQN611
Random type	10A	75 to 250V AC	AQN121
	15A		AQN221
	20A		AQN321
	25A		AQN421
	40A		AQN621

**2. With LED indication type**

Type	Load current	Load voltage	Part No.
Zero-cross type	10A	75 to 250V AC	AQN111L
	15A		AQN211L
	20A		AQN311L
	25A		AQN411L
	40A		AQN611L
Random type	10A	75 to 250V AC	AQN121L
	15A		AQN221L
	20A		AQN321L
	25A		AQN421L
	40A		AQN621L

**3. With varistor type**

Type	Load current	Load voltage	Part No.
Zero-cross type	10A	75 to 250V AC	AQN111V
	15A		AQN211V
	20A		AQN311V
	25A		AQN411V
	40A		AQN611V
Random type	10A	75 to 250V AC	AQN121V
	15A		AQN221V
	20A		AQN321V
	25A		AQN421V
	40A		AQN621V

**4. With varistor and LED indication type**

Type	Load current	Load voltage	Part No.
Zero-cross type	10A	75 to 250V AC	AQN111VL
	15A		AQN211VL
	20A		AQN311VL
	25A		AQN411VL
	40A		AQN611VL
Random type	10A	75 to 250V AC	AQN121VL
	15A		AQN221VL
	20A		AQN321VL
	25A		AQN421VL
	40A		AQN621VL

Standard packing; carton: 2 pcs., case: 100 pcs.

**5. Accessories**

Type	Part No.	Packaged quantity
Standard heat sink (10A, 15A and 20A)	AQP-HS-J10A	5 in a carton, 20 in a case
Standard heat sink (25A)	AQP-HS-30/40A	5 in a carton, 20 in a case
Standard heat sink (40A)	AQP-HS-J25A	No carton, 5 in a case
Slim heat sink (45mm wide) (Mountable on a DIN rail)	AQP-HS-SJ20A	No carton, 8 in a case
DIN rail mounting plate	AQP-DP	10 in a carton, 100 in a case
Terminal cover	AQP-NPC	2 in a carton, 100 in a case

**RATINGS**

**1. Ratings (Measurement condition: at 20°C 68°F, Input ripple: 1% or less)**

1) Zero-cross type

Item	Type	10A	15A	20A	25A	40A	Remarks
	Part No.	AQN111 AQN111L AQN111V AQN111VL	AQN211 AQN211L AQN211V AQN211VL	AQN311 AQN311L AQN311V AQN311VL	AQN411 AQN411L AQN411V AQN411VL	AQN611 AQN611L AQN611V AQN611VL	
Input side	Input voltage	4 to 32V					*1
	Input current	Max. 20mA					*1
	Drop-out voltage	Min. 1V					
Output side	Max. load current	10A	15A	20A	25A	40A	*2
	Load voltage	75V to 250V					
	Frequency	45Hz to 65Hz					
	Non-repetitive surge current	100A	150A	200A	250A	400A	In one cycle at 60Hz *3
	Max. "OFF-state" leakage current	Max. 10mA					at 60Hz
	Max. "ON-state" voltage drop	1.6V					at Max. carrying current
	Min. load current	100mA					*4

Notes: \*1. Please refer to REFERENCE DATA, "3. Input current vs. input voltage".

\*2. Please refer to REFERENCE DATA, "1. Load current vs. ambient temperature".

\*3. Please refer to REFERENCE DATA, "2. Non-repetitive surge current vs. carrying time".

\*4. When the load current is less than the rated minimum load current, please refer to "Cautions for Use of SSR".

# AQ-N

## 2) Random type

Item	Type	10A	15A	20A	25A	40A	Remarks
	Part No.	AQN121 AQN121L AQN121V AQN121VL	AQN221 AQN221L AQN221V AQN221VL	AQN321 AQN321L AQN321V AQN321VL	AQN421 AQN421L AQN421V AQN421VL	AQN621 AQN621L AQN621V AQN621VL	
Input side	Input voltage	4 to 32V					*1
	Input current	Max. 20mA					*1
	Drop-out voltage	Min. 1V					
Output side	Max. load current	10A	15A	20A	25A	40A	*2
	Load voltage	75V to 250V					
	Frequency	45Hz to 65Hz					
	Non-repetitive surge current	100A	150A	200A	250A	400A	In one cycle at 60Hz *3
	Max. "OFF-state" leakage current	Max. 10mA					at 60Hz
	Max. "ON-state" voltage drop	1.6V					at Max. carrying current
	Min. load current	100mA					*4

Notes: \*1. Please refer to REFERENCE DATA, "3. Input current vs. input voltage".

\*2. Please refer to REFERENCE DATA, "1. Load current vs. ambient temperature".

\*3. Please refer to REFERENCE DATA, "2. Non-repetitive surge current vs. carrying time".

\*4. When the load current is less than the rated minimum load current, please refer to "Cautions for Use of SSR".

## 2. Characteristics (Measurement condition: at 20°C 68°F, Input ripple: 1% or less)

### 1) Zero-cross type

Type	10A	15A	20A	25A	40A	Remarks
Part No.	AQN111 AQN111L AQN111V AQN111VL	AQN211 AQN211L AQN211V AQN211VL	AQN311 AQN311L AQN311V AQN311VL	AQN411 AQN411L AQN411V AQN411VL	AQN611 AQN611L AQN611V AQN611VL	
Operate time, max.	1/2 cycle of voltage sine wave + 1ms					
Release time, max.	1/2 cycle of voltage sine wave + 1ms					
Insulation resistance, min.	100MΩ between input and output					at 500 V DC
Breakdown voltage	4,000 Vrms between input and output; 2,500 Vrms between input, output and case					for 1min.
Vibration resistance (Functional)	10 to 55Hz double amplitude of 1.5mm					X, Y, Z axes
Shock resistance (Functional)	Min. 980 m/s <sup>2</sup>					X, Y, Z axes
Ambient temperature	-20°C to +80°C -4°F to +176°F*2					Non-condensing at low temperatures
Storage temperature	-25°C to +85°C -13°F to +185°F					
Operational method	Zero-cross (Turn-ON and Turn-OFF)					

### 2) Random type

Type	10A	15A	20A	25A	40A	Remarks
Part No.	AQN121 AQN121L AQN121V AQN121VL	AQN221 AQN221L AQN221V AQN221VL	AQN321 AQN321L AQN321V AQN321VL	AQN421 AQN421L AQN421V AQN421VL	AQN621 AQN621L AQN621V AQN621VL	
Operate time, max.	1ms					
Release time, max.	1/2 cycle of voltage sine wave + 1ms					
Insulation resistance, min.	100MΩ between input and output					at 500 V DC
Breakdown voltage	4,000 Vrms between input and output; 2,500 Vrms between input, output and case					for 1min.
Vibration resistance (Functional)	10 to 55Hz double amplitude of 1.5mm					X, Y, Z axes
Shock resistance (Functional)	Min. 980 m/s <sup>2</sup>					X, Y, Z axes
Ambient temperature	-20°C to +80°C -4°F to +176°F					Non-condensing at low temperatures
Storage temperature	-25°C to +85°C -13°F to +185°F					
Operational method	Random Turn-ON, Zero-cross Turn-OFF					

## REFERENCE DATA

### 1. Load current vs. ambient temperature

Use load current within range specified in the figure below.

Tested condition

#### With external heat sink

- 1) (1) 10A, 15A, 20A type  
Shown with standard heat sink (AQP801)
- (2) Shown with 25A type standard heat sink (AQP804)
- (3) Shown with 40A type standard heat sink (AQP806)
- (4) In the case of the AQP812 slim heat-sink types, characteristics data are available for each type. Please refer to (6).

- 2) If attached to a heat sink, use a heat conductive compound (Ex. Toshiba silicone YG6111 or TSK5303) of similar coating to improve cooling.

#### Without external heat sink

If the mounting surface is not metallic and a heat sink is not used, expose the bottom surface and plate surface to improve heat dissipation.

(1) 10A type

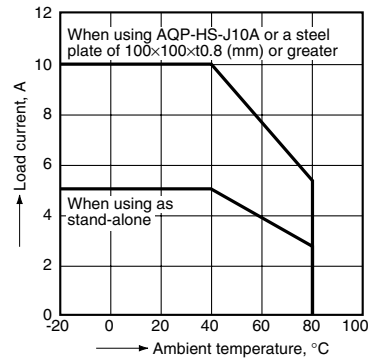

(2) 15A type

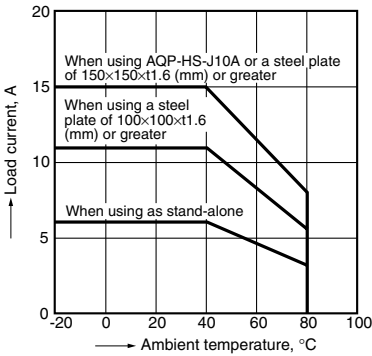

(3) 20A type

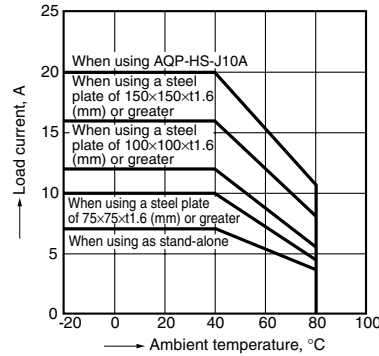

(4) 25A type

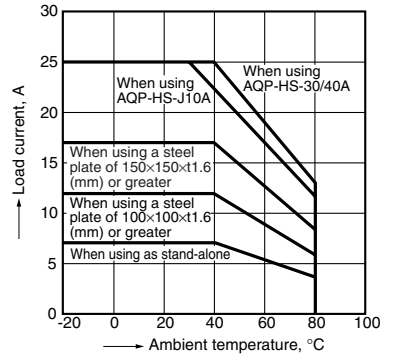

(5) 40A type

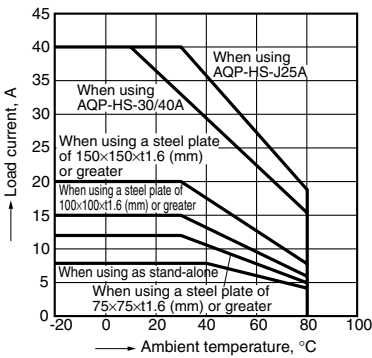

(6) Data when mounted on an AQP-HS-SJ20A slim heat sink

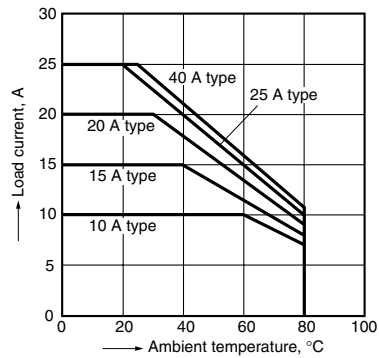

2. Non-repetitive surge current vs. carrying time

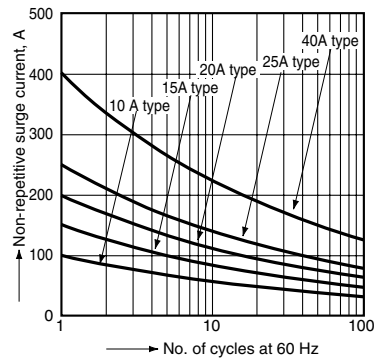

### 3. Input current vs. input voltage

10A, 15A, 20A, 25A, 40A common

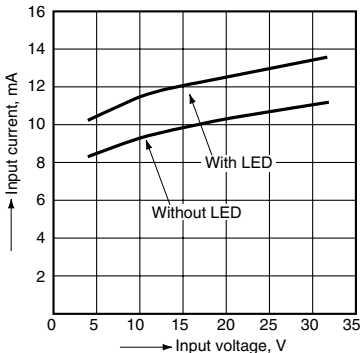

# AQ-N

## DIMENSIONS (mm inch)

The CAD data of the products with a **CAD Data** mark can be downloaded from: <http://panasonic-electric-works.net/ac>

\* The right figure is the LED indication type. The standard type has the same dimensions.

### CAD Data

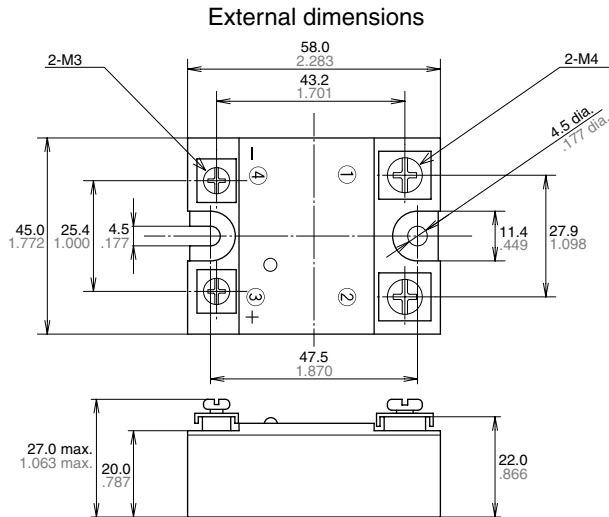

### Schematic

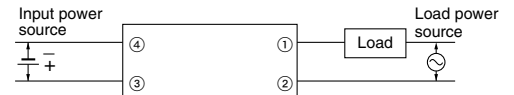

### Mounting dimensions

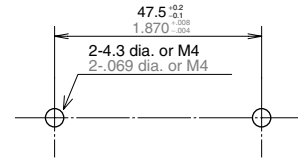

## ACCESSORIES

### AQP-HS-SJ20A Slim Heat Sink

#### CAD Data

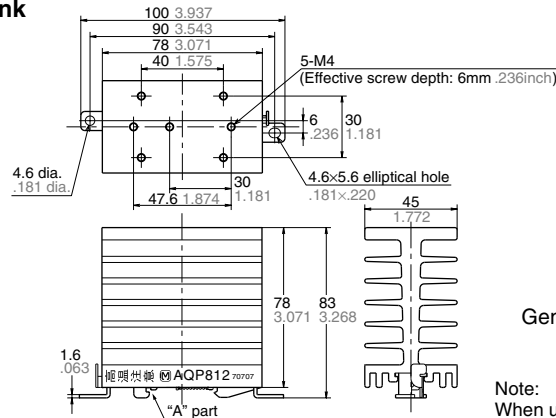
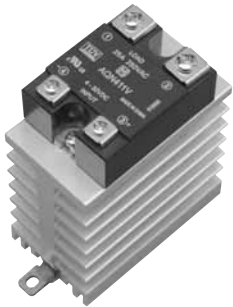

### Mounting dimensions

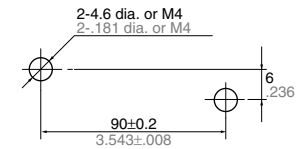

General tolerance:  $\pm 1.0 \pm .039$

Note: When using on a DIN rail, please install so that the "A" part is on top.

### AQP-HS-J10A Standard Heat Sink

#### CAD Data

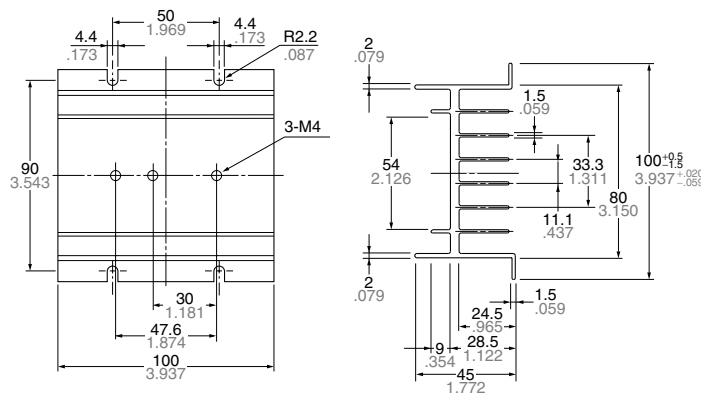
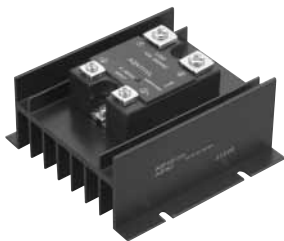

### Mounting dimensions

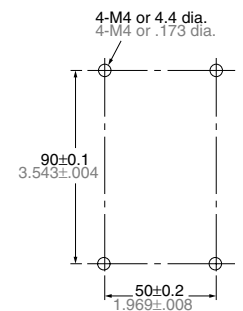

### AQP-HS-30/40A Standard Heat Sink

#### CAD Data

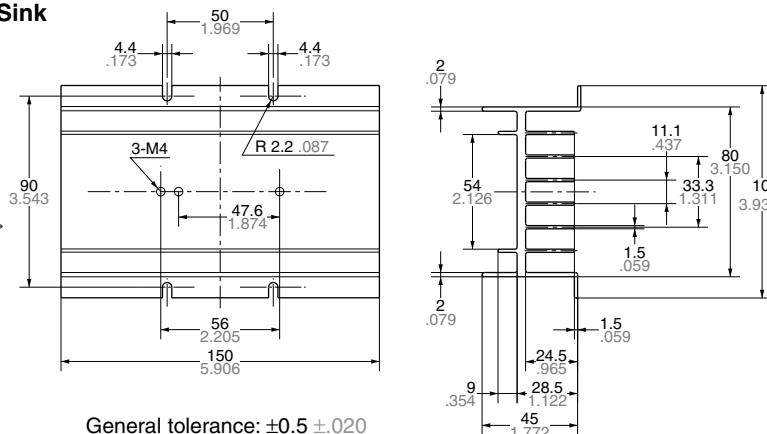

### Mounting dimensions

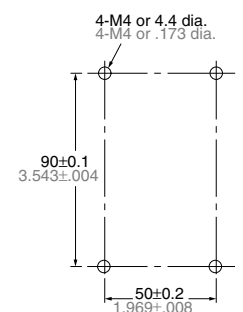

General tolerance:  $\pm 0.5 \pm .020$



## Recommended Temperature Controllers

### <KT4H Temperature Controller>

Our temperature controller is recommended for use with our Solid State Relays.

#### Features

- Data can be collected using the RS485 communications interface via a PLC.
- Improved visibility using a negative type LCD and backlight.
- Depth-wise length (chassis dimension) is 56 mm 2.205 inch.

#### Substitute part numbers

Power supply	Control output	Part No.
100 to 240 V AC	Relay contact	AKT4H111100

\*For detailed product information about temperature controllers, please refer to our website:  
[http://panasonic-denko.co.jp/ac/e/fasys/component/temperature\\_controller/](http://panasonic-denko.co.jp/ac/e/fasys/component/temperature_controller/)



## For Cautions for Use

# Mouser Electronics

Authorized Distributor

Click to View Pricing, Inventory, Delivery & Lifecycle Information:

Panasonic:

[AQP-HS-30/40A](#) [AQP-HS-J25A](#)