

MAXIM

Quad, SPST, Ultra-Low Leakage, CMOS Analog Switches

MAX326/MAX327

General Description

The MAX326/MAX327 quad, single-pole-single-throw (SPST), CMOS analog switches upgrade the DG201A/DG202 and DG211/DG212 with at least 100 times less leakage—the MAX326/MAX327 have 10pA maximum leakage, while the DG201A/DG202 have 1000pA and the DG211/DG212 have 5000pA. Low leakage currents support high system accuracy and make the devices useful for switching into high impedances, such as large-value feedback resistors in closed-loop gain configurations. And the MAX326/MAX327 logic inputs are CMOS and TTL compatible.

The MAX326/MAX327's low charge injection (2pC typ) minimizes signal error. Operation from single supplies (+10V to +30V), dual supplies ($\pm 5V$ to $\pm 18V$), and unbalanced combinations (i.e. +12V and -5V, or +5V and -15V) maximizes design flexibility. Both parts also feature interchangeable inputs/outputs and Maxim's standard latchup-proof construction.

Extremely low power consumption (5.25mW max) makes the MAX326/MAX327 ideal for portable applications. Other programmable applications include integrators with long RC time constants, current-to-voltage converters, high-gain amplifiers, and voltage dividers.

Applications

- High-Accuracy Data Acquisition Systems
- Sample-and-Hold Circuits
- Communication Systems
- Guidance and Control Systems
- Test Equipment

Typical Operating Circuit

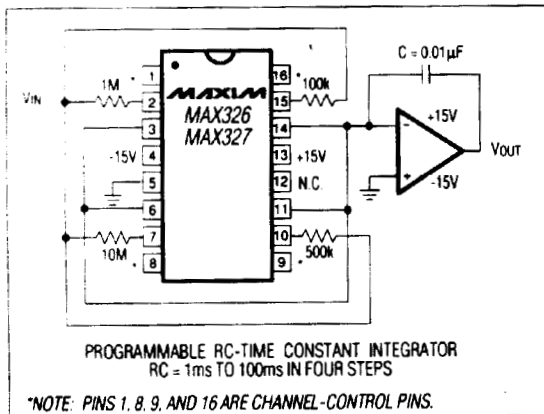

Features

- ◆ 10pA Max Leakage (<1pA Typ)
- ◆ Plug-In, Low-Leakage Upgrades for DG201A/DG202 and DG211/DG212
- ◆ Interchangeable Inputs/Outputs
- ◆ CMOS and TTL Compatible
- ◆ 2pC Typ Charge Injection
- ◆ Single- (+10V to +30V), Bipolar- ($\pm 5V$ to $\pm 18V$), or Unbalanced- (i.e. +12V and -5V) Supply Operation
- ◆ 5.25mW Max Power Consumption
- ◆ Latchup-Proof Construction

Ordering Information

PART	TEMP. RANGE	PIN-PACKAGE
MAX326CPE	0°C to +70°C	16 Plastic DIP
MAX326CEE	0°C to +70°C	16 QSOP
MAX326CSE	0°C to +70°C	16 Narrow SO
MAX326CJE	0°C to +70°C	16 CERDIP**
MAX326C/D	0°C to +70°C	Dice*
MAX326EPE	-40°C to +85°C	16 Plastic DIP
MAX326EEE	-40°C to +85°C	16 QSOP
MAX326ESE	-40°C to +85°C	16 Narrow SO
MAX326EJE	-40°C to +85°C	16 CERDIP**
MAX326MJE	-55°C to +125°C	16 CERDIP**

Ordering information continued on page 6.

*Contact factory for dice specifications.

**Contact factory for availability.

Pin Configuration

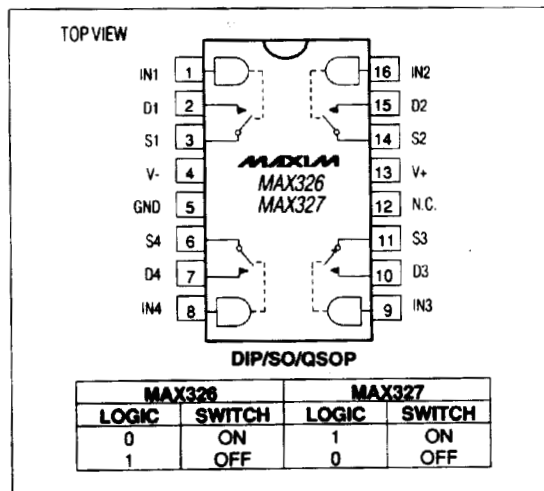

MAXIM

Maxim Integrated Products 1

For free samples & the latest literature: <http://www.maxim-ic.com>, or phone 1-800-998-8800

Quad, SPST, Ultra-Low Leakage, CMOS Analog Switches

ABSOLUTE MAXIMUM RATINGS

V+ to V-	+44V
V _{IN} to GND	V-, V+
V _S , V _D (Note 1)	(V- - 0.3V) to (V+ + 0.3V)
V+ to GND (V- = 0V)	+40V
Current (any terminal, except S or D)	30mA
Continuous Current, S or D	20mA
Peak Current, S or D	70mA

Operating Temperature Ranges:

MAX32_C	0°C to +70°C
MAX32_E	-40°C to +85°C
MAX32_MJE	-55°C to +125°C
Storage Temperature Range	-65°C to +150°C
Lead Temperature (soldering, 10 sec)	+300°C

(pulsed at 1ms, 10% duty cycle max)

Continuous Total Power Dissipation (Note 2)

16-Pin Plastic DIP (derate 7.5mW/°C above +70°C)	470mW
16-Pin QSOP (derate 9.52mW/°C above +70°C)	762mW
16-Pin Narrow SO (derate 10mW/°C above +70°C)	400mW
16-Pin CERDIP (derate 10mW/°C above +70°C)	900mW

Note 1: Exceeding this limit is acceptable as long as the S or D current is less than 20mA.

Note 2: All leads soldering or welding to PC board.

Stresses beyond those listed under "Absolute Maximum Ratings" may cause permanent damage to the device. These are stress ratings only, and functional operation of the device at these or any other conditions beyond those indicated in the operational sections of the specifications is not implied. Exposure to absolute maximum rating conditions for extended periods may affect device reliability.

ELECTRICAL CHARACTERISTICS

(V+ = 15V, V- = -15V, T_A = +25°C, unless otherwise noted.)

PARAMETER	SYMBOL	CONDITIONS	MAX32_M			MAX32_C/E			UNITS
			MIN	TYP	MAX	MIN	TYP	MAX	
SWITCH									
Analog-Signal Range	V _{ANALOG}		T _{MIN} to T _{MAX}	±15		±15		V	
Drain-Source On Resistance	R _{DS(ON)}	V _{IN} = 0.8V (MAX326), V _{IN} = 2.4V (MAX327), V _D = ±10V, I _S = 100µA	T _A = +25°C	1.5	2.5	1.5	3.5	kΩ	
		T _{MIN} to T _{MAX}	2.2	4	1.9	5			
On-Resistance Match			T _A = +25°C	5		5		%	
Source-Off Leakage Current (Note 3)	I _{S(OFF)}	V _{IN} = 2.4V (MAX326), V _{IN} = 0.8V (MAX327), V _S = 14V, V _D = -14V	T _A = +25°C	0.1	±10	0.1	±10	pA	
		T _{MIN} to T _{MAX}	±5		±5		nA		
		V _{IN} = 2.4V (MAX326), V _{IN} = 0.8V (MAX327), V _S = 14V, V _D = 14V	T _A = +25°C	0.2	±10	0.2	±10	pA	
		T _{MIN} to T _{MAX}	±5		±5		nA		
Drain-Off Leakage Current (Note 3)	I _{D(OFF)}	V _{IN} = 2.4V (MAX326), V _{IN} = 0.8V (MAX327), V _S = 14V, V _D = -14V	T _A = +25°C	0.1	±10	0.1	±10	pA	
		T _{MIN} to T _{MAX}	±5		±5		nA		
		V _{IN} = 2.4V (MAX326), V _{IN} = 0.8V (MAX327), V _S = 14V, V _D = 14V	T _A = +25°C	0.2	±10	0.2	±20	pA	
		T _{MIN} to T _{MAX}	±5		±5		nA		
Drain-On Leakage Current (Note 3)	I _{D(ON)}	V _{IN} = 0.8V (MAX326), V _{IN} = 2.4V (MAX327), V _S = V _D = 14V	T _A = +25°C	1	±10	1	±10	pA	
		T _{MIN} to T _{MAX}	±10		±10		nA		
		V _{IN} = 0.8V (MAX326), V _{IN} = 2.4V (MAX327), V _S = V _D = -14V	T _A = +25°C	2	±10	2	±10	pA	
		T _{MIN} to T _{MAX}	±10		±10		nA		
INPUT									
Input Current with Input Voltage High	I _{INH}	V _{IN} = 2.4V	T _{MIN} to T _{MAX}	-1	-0.0004	-1	-0.0004	µA	
		V _{IN} = 15V	T _{MIN} to T _{MAX}	0.003	1	0.003	1		
Input Current with Input Voltage Low	I _{INL}	V _{IN} = 0V	T _{MIN} to T _{MAX}	-1	-0.0004	-1	-0.0004	µA	

Quad, SPST, Ultra-Low Leakage, CMOS Analog Switches

MAX326/MAX327

ELECTRICAL CHARACTERISTICS (continued)

(V+ = 15V, V- = -15V, TA = +25°C, unless otherwise noted.)

PARAMETER	SYMBOL	CONDITIONS	MAX32_M			MAX32_C/E			UNITS
			MIN	TYP	MAX	MIN	TYP	MAX	
SUPPLY									
Positive Supply Current	I+	V _{IN} = 0V or 5V on all inputs	0.09	0.25		0.09	0.25	mA	
Negative Supply Current	I-	V _{IN} = 0V or 5V on all inputs	-0.1	-0.00001		-0.1	-0.00001	mA	
Power-Supply Range for Continuous Operation		(Note 4)	±4.5		±18	±4.5		±18	V
DYNAMIC									
Turn-On Time	t _{ON}	V _S = 2V, R _L = 1kΩ, C _L = 35pF (Figure 1)	500	1000		500	1000	ns	
Turn-Off Time	t _{OFF}	V _S = 2V, R _L = 1kΩ, C _L = 35pF (Figure 1)	50	500		50	500	ns	
Charge Injection (Note 5)	Q	C _L = 0.01μF, V _{GEN} = 0V, R _{GEN} = 0Ω	2	5		2	5	pC	
Off Isolation (Note 4)	OIRR	V _{IN} = 5V, R _L = 1kΩ, C _L = 15pF, V _S = 1V _{RMS} , f = 100kHz	70			70		dB	
Crosstalk (Channel-to-Channel)	CCRR	V _{IN} = 5V, R _L = 1kΩ, C _L = 15pF, V _S = 1V _{RMS} , f = 100kHz	90			90		dB	
Source-Off Capacitance	C _{S(OFF)}	V _S = 0V, V _{IN} = 5V, f = 1MHz	1.7			1.7		pF	
Drain-Off Capacitance	C _{D(OFF)}	V _S = 0V, V _{IN} = 5V, f = 1MHz	1.7			1.7		pF	
Channel-On Capacitance	C _{D(ON)} + C _{S(ON)}	V _D = V _S = 0V, V _{IN} = 0V, f = 1MHz	6			6		pF	

Note 3: All leakage parameters are 100% tested at maximum rated operating temperatures, i.e. +70°C, +85°C, or +125°C, and guaranteed by correlation at +25°C.

Note 4: Electrical characteristics, such as r_{DS(ON)}, will change when power supplies other than ±15V are used. Power-supply range is a design characteristic, not production tested.

Note 5: Guaranteed by design.

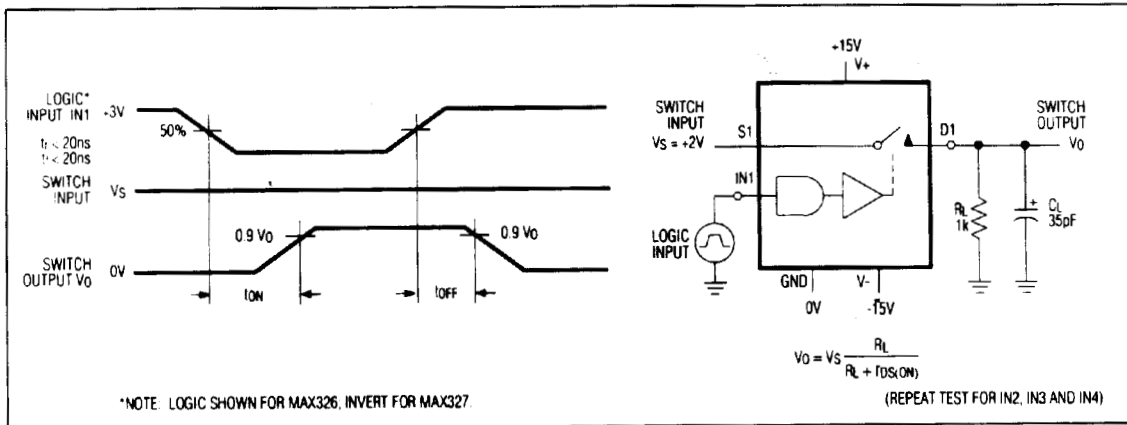
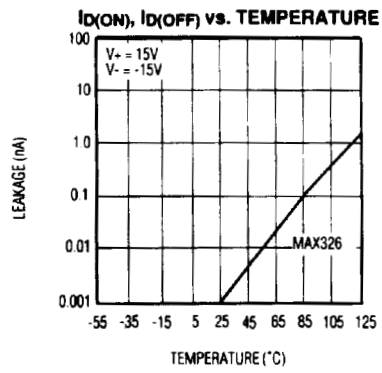
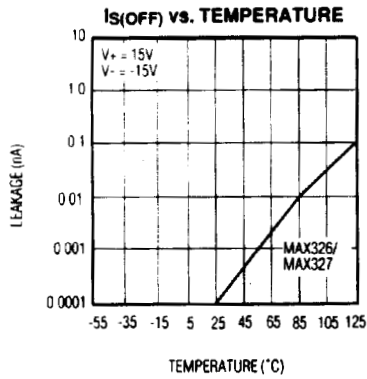
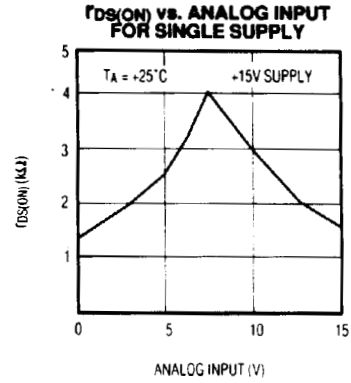
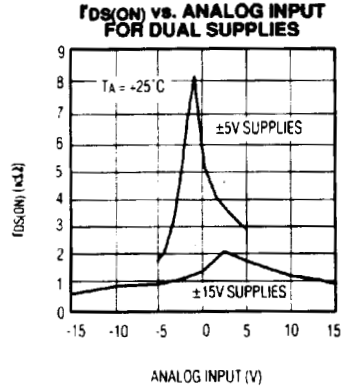

Figure 1. Switching-Time Test Circuit. Switch-output waveform shown for V_S = constant with logic-input waveform as shown. Note: V_S may be positive or negative as per switching-time test circuit. V_O is the steady-state output with switch on. Feedthrough via gate capacitance may result in spikes at leading and trailing edge of output waveform.

Quad, SPST, Ultra-Low Leakage, CMOS Analog Switches

Typical Operating Characteristics



Quad, SPST, Ultra-Low Leakage, CMOS Analog Switches

MAX326/MAX327

Application Hints

The MAX326/MAX327 are pin-compatible upgrades for the DG201A/DG202 and DG211/DG212. The MAX326/MAX327 feature significantly lower leakages (at least 100 times less at +25°C), but with higher on-resistance. Low leakage minimizes signal error in most applications that require signal switching into high-impedance inputs of A/Ds or op amps. Switching times are virtually identical, as shown in Table 1.

Table 1. Switching Speeds with Various Power-Supply Combinations

POWER SUPPLY (V)	t _{ON} (μs)	t _{OFF} (ns)
±15	0.5	50
±10	1	80
±5	2.5	200
+10	2.5	200
+15	1.5	100

The MAX326/MAX327 work well in single-supply applications from +10V to +30V. For these applications, V₊ should be connected to ground, and signal levels equal to the rail can be switched. ±5V to ±18V dual supplies can also be used to increase design flexibility.

Channel-to-channel on-resistance matching is typically better than 95% for a given analog input level. *Typical Operating Characteristics* show how r_{DS(ON)} changes with various analog inputs and power-supply combinations.

While specified at TTL threshold levels, the logic threshold is roughly 1.5V ±0.2V and switches properly with CMOS input levels from -15V to +15V. Logic input levels should never be allowed to exceed the supply rails.

Protecting Against Fault Conditions

Fault conditions develop when power supplies are turned off with input signals still present, or when overvoltages occur at the inputs during normal operation. In either case, source-to-body diodes can be forward biased to conduct current from the signal source. If low current levels are required, the addition of external protection diodes is recommended (Figure 2).

To provide protection for overvoltages up to 20V above the supply rails, a 1N4001 or 1N914 diode should be placed in series with the positive and negative supplies (Figure 2). The addition of these diodes will reduce the analog signal range to 1V below the positive supply and 1V above the negative supply.

For signals that can be momentarily shorted to the 110VAC line, the addition of a 47kΩ, 1/2W resistor in series with the channel input is recommended. This will protect the switch and allow normal operation to continue once the fault condition abates. The throughput resistance will then be 47kΩ plus r_{DS(ON)}, but low switch leakage will reduce the error while maintaining superior system reliability.

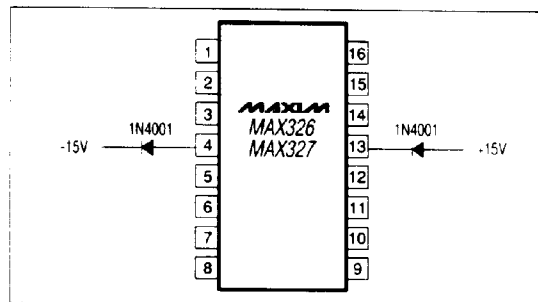

Figure 2. Protection Against Fault Conditions

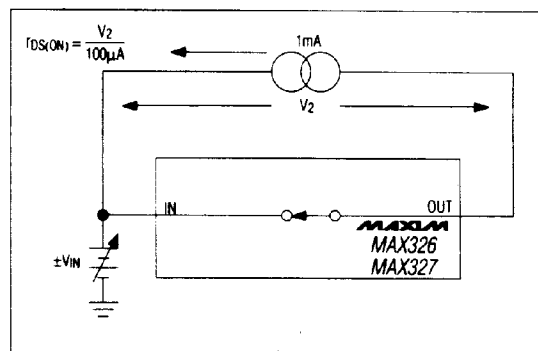

Figure 3. On Resistance vs. Analog-Signal Level Supply Voltage

Quad, SPST, Ultra-Low Leakage, CMOS Analog Switches

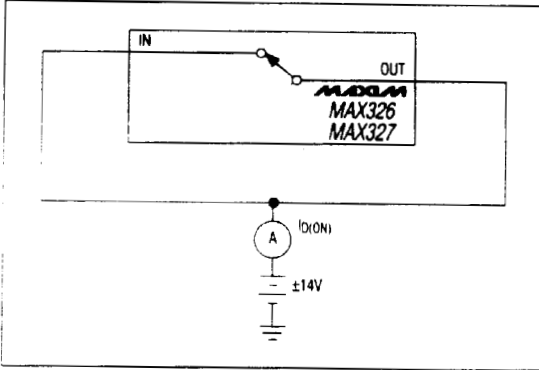

Figure 4. On Leakage Current Test Circuit

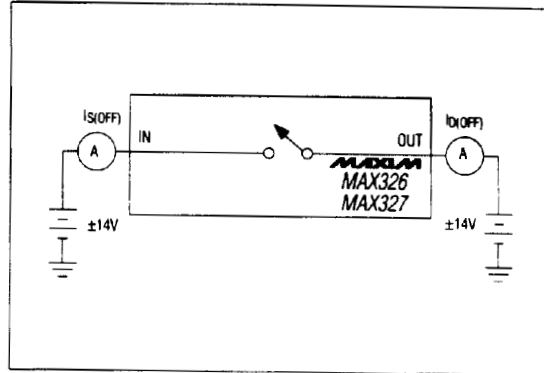

Figure 5. Off Leakage Current Test Circuit

Ordering Information (continued)

PART	TEMP. RANGE	PIN-PACKAGE
MAX327CPE	0°C to +70°C	16 Plastic DIP
MAX327CEE	0°C to +70°C	16 QSOP
MAX327CSE	0°C to +70°C	16 Narrow SO
MAX327CJE	0°C to +70°C	16 CERDIP**
MAX327C/D	0°C to +70°C	Dice*
MAX327EPE	-40°C to +85°C	16 Plastic DIP
MAX327EEE	-40°C to +85°C	16 QSOP
MAX327ESE	-40°C to +85°C	16 Narrow SO
MAX327EJE	-40°C to +85°C	16 CERDIP**
MAX327MJE	-55°C to +125°C	16 CERDIP**

*Contact factory for dice specifications. Substrate may be allowed to float or be tied to V+.

**Contact factory for availability.

Chip Topography

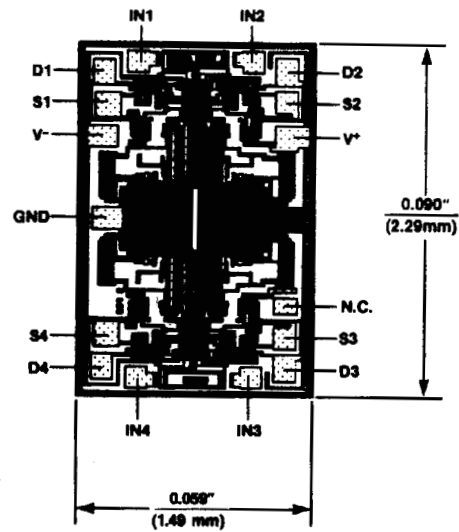

SUBSTRATE CONNECTED TO V+

Quad, SPST, Ultra-Low Leakage, CMOS Analog Switches

Package Information

MAX326/MAX327

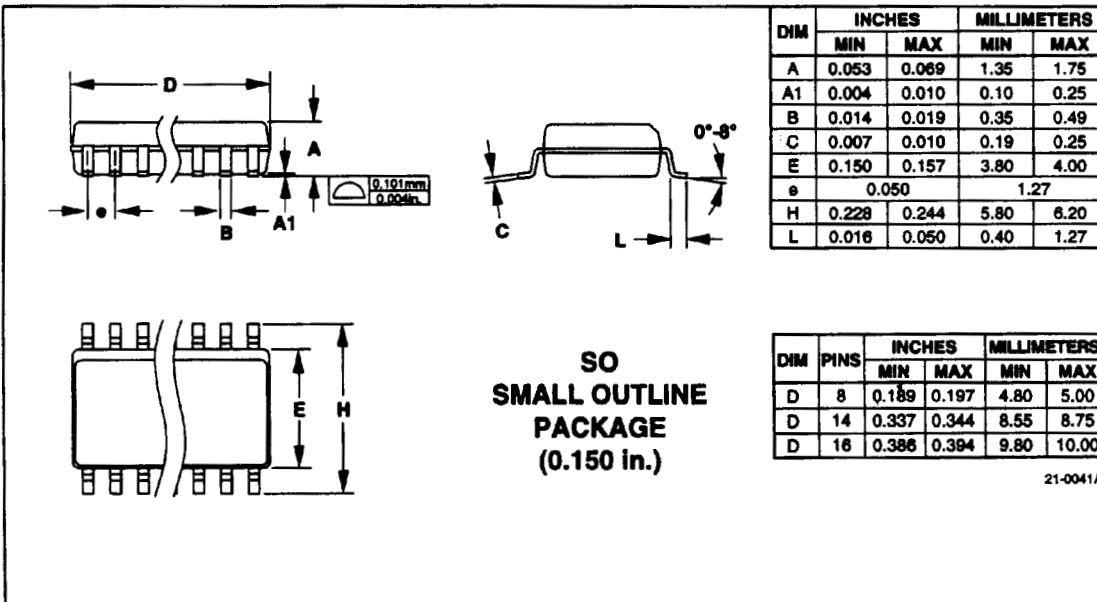
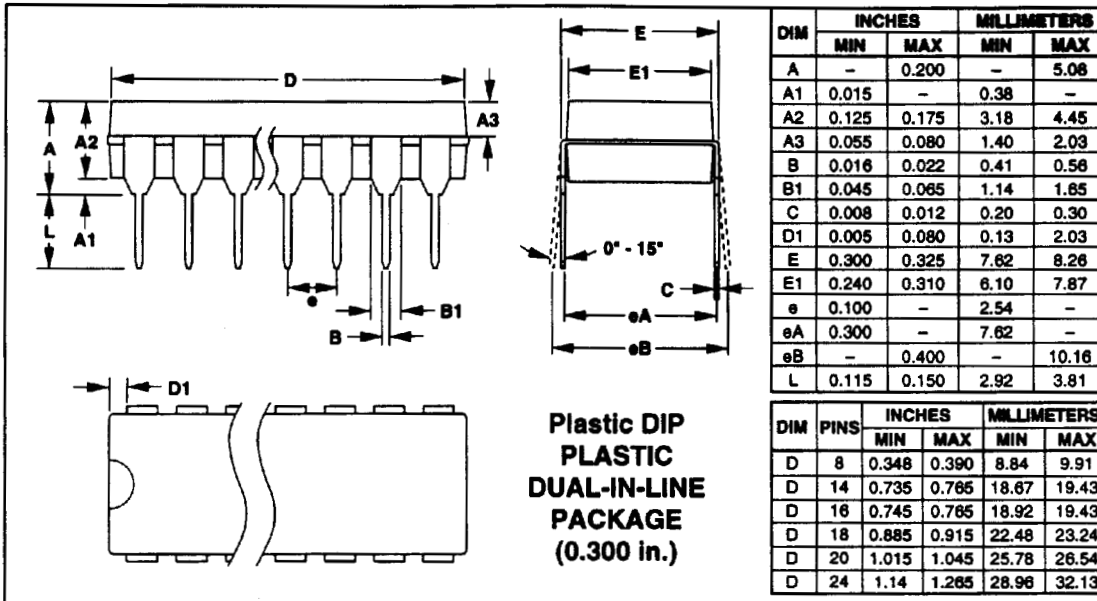

Quad, SPST, Ultra-Low Leakage, CMOS Analog Switches

Package Information (continued)

**CERDIP
CERAMIC DUAL-IN-LINE
PACKAGE
(0.300 in.)**

DIM	INCHES		MILLIMETERS	
	MIN	MAX	MIN	MAX
A	-	0.200	-	5.08
B	0.014	0.023	0.36	0.58
B1	0.038	0.065	0.97	1.65
C	0.008	0.015	0.20	0.38
E	0.220	0.310	5.59	7.87
E1	0.290	0.320	7.37	8.13
e	0.100		2.54	
L	0.125	0.200	3.18	5.08
L1	0.150	-	3.81	-
Q	0.015	0.070	0.38	1.78
S	-	0.098	-	2.49
S1	0.005	-	0.13	-

DIM	PINS	INCHES		MILLIMETERS	
		MIN	MAX	MIN	MAX
D	8	-	0.405	-	10.29
D	14	-	0.785	-	19.94
D	16	-	0.840	-	21.34
D	18	-	0.960	-	24.38
D	20	-	1.060	-	26.92
D	24	-	1.280	-	32.51

21-0045A

**QSOP
QUARTER
SMALL-OUTLINE
PACKAGE**

DIM	INCHES		MILLIMETERS	
	MIN	MAX	MIN	MAX
A	0.061	0.068	1.55	1.73
A1	0.004	0.0098	0.127	0.25
A2	0.055	0.061	1.40	1.55
B	0.008	0.012	0.20	0.31
C	0.0075	0.0098	0.19	0.25
D	SEE VARIATIONS			
E	0.150	0.157	3.81	3.99
e	0.25 BSC		0.635 BSC	
H	0.230	0.244	5.84	6.20
h	0.010	0.016	0.25	0.41
L	0.016	0.035	0.41	0.89
N	SEE VARIATIONS			
S	SEE VARIATIONS			
alpha	0°	8°	0°	8°

DIM	PINS	INCHES		MILLIMETERS	
		MIN	MAX	MIN	MAX
D	16	0.189	0.196	4.80	4.98
S	16	0.0020	0.0070	0.05	0.18
D	20	0.337	0.344	8.56	8.74
S	20	0.0500	0.0550	1.27	1.40
D	24	0.337	0.344	8.56	8.74
S	24	0.0250	0.0300	0.64	0.76
D	28	0.386	0.393	9.80	9.98
S	28	0.0250	0.0300	0.64	0.76

21-0055A

Maxim cannot assume responsibility for use of any circuitry other than circuitry entirely embodied in a Maxim product. No circuit patent licenses are implied. Maxim reserves the right to change the circuitry and specifications without notice at any time.

8 Maxim Integrated Products, 120 San Gabriel Drive, Sunnyvale, CA 94086 (408) 737-7600

Mouser Electronics

Authorized Distributor

Click to View Pricing, Inventory, Delivery & Lifecycle Information:

Maxim Integrated:

[MAX326CPE+](#) [MAX326CSE+](#) [MAX326CEE+](#) [MAX326CEE+T](#) [MAX326CSE+T](#) [MAX326ESE+](#) [MAX326ESE+T](#)
[MAX327CPE+](#) [MAX327CSE+](#) [MAX327CSE+T](#) [MAX327EPE+](#) [MAX327ESE+](#) [MAX327ESE+T](#)