

RF Power LDMOS Transistors

N-Channel Enhancement-Mode Lateral MOSFETs

Designed for broadcast and commercial aerospace broadband applications with frequencies from 470 to 1215 MHz.

- Typical Performance (UHF 470-860 Reference Circuit): $V_{DD} = 50$ Volts, $I_{DQ} = 450$ mA, 64 QAM, Input Signal PAR = 9.5 dB @ 0.01% Probability on CCDF.

Signal Type	P_{out} (W)	f (MHz)	G_{ps} (dB)	η_D (%)	Output Signal PAR (dB)	IMD Shoulder (dBc)
DVB-T (8k OFDM)	18 Avg.	470	21.8	31.0	7.9	-27.8
		650	21.6	26.4	8.4	-37.6
		860	21.7	27.6	7.1	-30.4

- Typical Performance (L-Band 960-1215 MHz Circuit): $V_{DD} = 50$ Volts, $I_{DQ} = 100$ mA.

Signal Type	P_{out} (W)	f (MHz)	P_{in} (W)	G_{ps} (dB)	η_D (%)
Pulse (128 μ sec, 10% Duty Cycle)	90 Peak	960	1.3	18.4	55.3
		1030	1.41	18	56.9
		1090	1.65	17.4	50.7
		1215	1.68	17.3	51.0

Features

- Capable of Handling 10:1 VSWR, All Phase Angles, @ 50 Vdc, 860 MHz, 90 Watts CW Output Power
- Characterized with Series Equivalent Large-Signal Impedance Parameters
- Internally Input Matched for Ease of Use
- Qualified Up to a Maximum of 50 V_{DD} Operation
- Excellent Thermal Stability
- Device can be used Single-Ended or in a Push-Pull Configuration
- Integrated ESD Protection
- Greater Negative Gate-Source Voltage Range for Improved Class C Operation

MRF6VP3091N MRF6VP3091NB

**470-1215 MHz, 90 W, 50 V
BROADBAND
RF POWER LDMOS TRANSISTORS**

**TO-270WB-4
PLASTIC
MRF6V3090N**

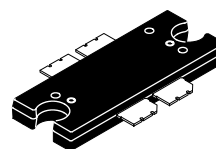
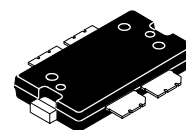

**TO-272WB-4
PLASTIC
MRF6V3090NB**

PARTS ARE PUSH-PULL

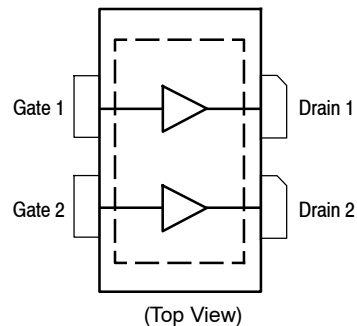

Note: Exposed backside of the package is the source terminal for the transistor.

Figure 1. Pin Connections

Table 1. Maximum Ratings

Rating	Symbol	Value	Unit
Drain-Source Voltage	V_{DSS}	-0.5, +115	Vdc
Gate-Source Voltage	V_{GS}	-6.0, +10	Vdc
Storage Temperature Range	T_{stg}	-65 to +150	°C
Case Operating Temperature	T_C	150	°C
Operating Junction Temperature (1,2)	T_J	225	°C

Table 2. Thermal Characteristics

Characteristic	Symbol	Value (2,3)	Unit
Thermal Resistance, Junction to Case Case Temperature 76°C, 18 W CW, 50 Vdc, $I_{DQ} = 350$ mA, 860 MHz Case Temperature 80°C, 90 W CW, 50 Vdc, $I_{DQ} = 350$ mA, 860 MHz	$R_{\theta JC}$	0.79 0.82	°C/W

Table 3. ESD Protection Characteristics

Test Methodology	Class
Human Body Model (per JESD22-A114)	2 (2001-4000 V)
Machine Model (per EIA/JESD22-A115)	B (201-400 V)
Charge Device Model (per JESD22-C101)	IV (>1000 V)

Table 4. Moisture Sensitivity Level

Test Methodology	Rating	Package Peak Temperature	Unit
Per JESD22-A113, IPC/JEDEC J-STD-020	3	260	°C

Table 5. Electrical Characteristics ($T_A = 25^\circ\text{C}$ unless otherwise noted)

Characteristic	Symbol	Min	Typ	Max	Unit
----------------	--------	-----	-----	-----	------

Off Characteristics (4)

Gate-Source Leakage Current ($V_{GS} = 5$ Vdc, $V_{DS} = 0$ Vdc)	I_{GSS}	—	—	0.5	μAdc
Drain-Source Breakdown Voltage ($I_D = 50$ mA, $V_{GS} = 0$ Vdc)	$V_{(BR)DSS}$	115	—	—	Vdc
Zero Gate Voltage Drain Leakage Current ($V_{DS} = 50$ Vdc, $V_{GS} = 0$ Vdc)	I_{DSS}	—	—	10	μAdc
Zero Gate Voltage Drain Leakage Current ($V_{DS} = 100$ Vdc, $V_{GS} = 0$ Vdc)	I_{DSS}	—	—	20	μAdc

On Characteristics

Gate Threshold Voltage (4) ($V_{DS} = 10$ Vdc, $I_D = 100$ μAdc)	$V_{GS(th)}$	0.9	1.6	2.4	Vdc
Gate Quiescent Voltage ($V_{DD} = 50$ Vdc, $I_D = 350$ mA, Measured in Functional Test)	$V_{GS(Q)}$	2.0	2.7	3.5	Vdc
Drain-Source On-Voltage (4) ($V_{GS} = 10$ Vdc, $I_D = 0.25$ Adc)	$V_{DS(on)}$	—	0.2	—	Vdc

Dynamic Characteristics

Reverse Transfer Capacitance (5) ($V_{DS} = 50$ Vdc ± 30 mV(rms)ac @ 1 MHz, $V_{GS} = 0$ Vdc)	C_{rss}	—	41	—	pF
Output Capacitance (5) ($V_{DS} = 50$ Vdc ± 30 mV(rms)ac @ 1 MHz, $V_{GS} = 0$ Vdc)	C_{oss}	—	65.4	—	pF
Input Capacitance (5) ($V_{DS} = 50$ Vdc, $V_{GS} = 0$ Vdc ± 30 mV(rms)ac @ 1 MHz)	C_{iss}	—	591	—	pF

1. Continuous use at maximum temperature will affect MTTF.
2. MTTF calculator available at <http://www.freescale.com/rf>. Select Software & Tools/Development Tools/Calculators to access MTTF calculators by product.
3. Refer to AN1955, *Thermal Measurement Methodology of RF Power Amplifiers*. Go to <http://www.freescale.com/rf>. Select Documentation/Application Notes - AN1955.
4. Each side of device measured separately.
5. Part internally input matched.

(continued)

MRF6VP3091N MRF6VP3091NB

Table 5. Electrical Characteristics ($T_A = 25^\circ\text{C}$ unless otherwise noted) (continued)

Characteristic	Symbol	Min	Typ	Max	Unit
Functional Tests (In Freescale Single-Ended Narrowband Test Fixture, 50 ohm system) $V_{DD} = 50\text{ Vdc}$, $I_{DQ} = 350\text{ mA}$, $P_{out} = 18\text{ W Avg.}$, $f = 860\text{ MHz}$, DVB-T (8k OFDM) Single Channel. ACPR measured in 7.61 MHz Channel Bandwidth @ $\pm 4\text{ MHz}$ Offset @ 4 kHz Bandwidth.					
Power Gain	G_{ps}	21.0	22.0	24.0	dB
Drain Efficiency	η_D	27.5	28.5	—	%
Adjacent Channel Power Ratio	ACPR	—	-62.0	-60.0	dBc
Input Return Loss	IRL	—	-14	-9	dB

Table 6. Ordering Information

Device	Tape and Reel Information	Package
MRF6V3090NR1	R1 Suffix = 500 Units, 44 mm Tape Width, 13-inch Reel	TO-270WB-4
MRF6V3090NBR1		TO-272WB-4
MRF6V3090NR5	R5 Suffix = 50 Units, 56 mm Tape Width, 13-inch Reel	TO-270WB-4
MRF6V3090NBR5		TO-272WB-4

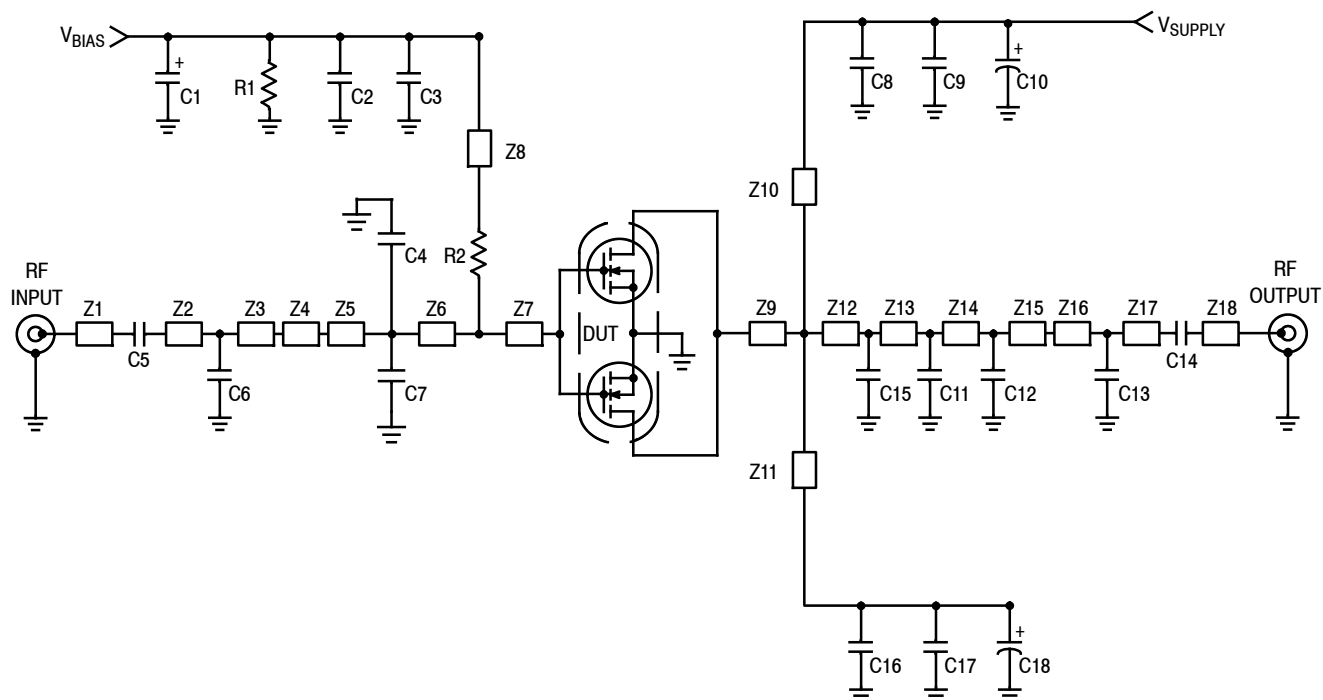

Z1	0.266" × 0.067" Microstrip	Z10, Z11	1.292" × 0.079" Microstrip
Z2	0.331" × 0.067" Microstrip	Z12	0.680" × 0.571" Microstrip
Z3	0.598" × 0.067" Microstrip	Z13	0.132" × 0.117" Microstrip
Z4	0.315" × 0.276" Microstrip	Z14	0.705" × 0.117" Microstrip
Z5	0.054" × 0.669" Microstrip	Z15	0.159" × 0.117" Microstrip
Z6	0.419" × 0.669" Microstrip	Z16	0.140" × 0.067" Microstrip
Z7	0.256" × 0.669" Microstrip	Z17	0.077" × 0.067" Microstrip
Z8	0.986" × 0.071" Microstrip	Z18	0.163" × 0.067" Microstrip
Z9	0.201" × 0.571" Microstrip		

Figure 2. MRF6VP3091N 860 MHz Single-Ended Narrowband Test Circuit Schematic

Table 7. MRF6VP3091N 860 MHz Single-Ended Narrowband Test Circuit Component Designations and Values

Part	Description	Part Number	Manufacturer
C1	22 μ F, 35 V Tantalum Capacitor	T491X226K035AT	Kemet
C2, C9, C17	10 μ F, 50 V Chip Capacitors	GRM55DR61H106KA88L	Murata
C3, C5, C8, C14, C16	43 pF Chip Capacitors	ATC100B430JT500XT	ATC
C4	6.2 pF Chip Capacitor	ATC100B6R2BT500XT	ATC
C6	2.2 pF Chip Capacitor	ATC100B2R2JT500XT	ATC
C7	9.1 pF Chip Capacitor	ATC100B9R1CT500XT	ATC
C10, C18	220 μ F, 100 V Electrolytic Capacitors	EEVFK2A221M	Panasonic-ECG
C11, C15	7.5 pF Chip Capacitors	ATC100B7R5CT500XT	ATC
C12	3.0 pF Chip Capacitor	ATC100B3R0CT500XT	ATC
C13	0.7 pF Chip Capacitor	ATC100B0R7BT500XT	ATC
R1	10 k Ω , 1/4 W Chip Resistor	CRCW120610K0JNEA	Vishay
R2	10 Ω , 1/4 W Chip Resistor	CRCW120610R0JNEA	Vishay
PCB	0.030", $\epsilon_r = 3.5$	RF-35	Taconic

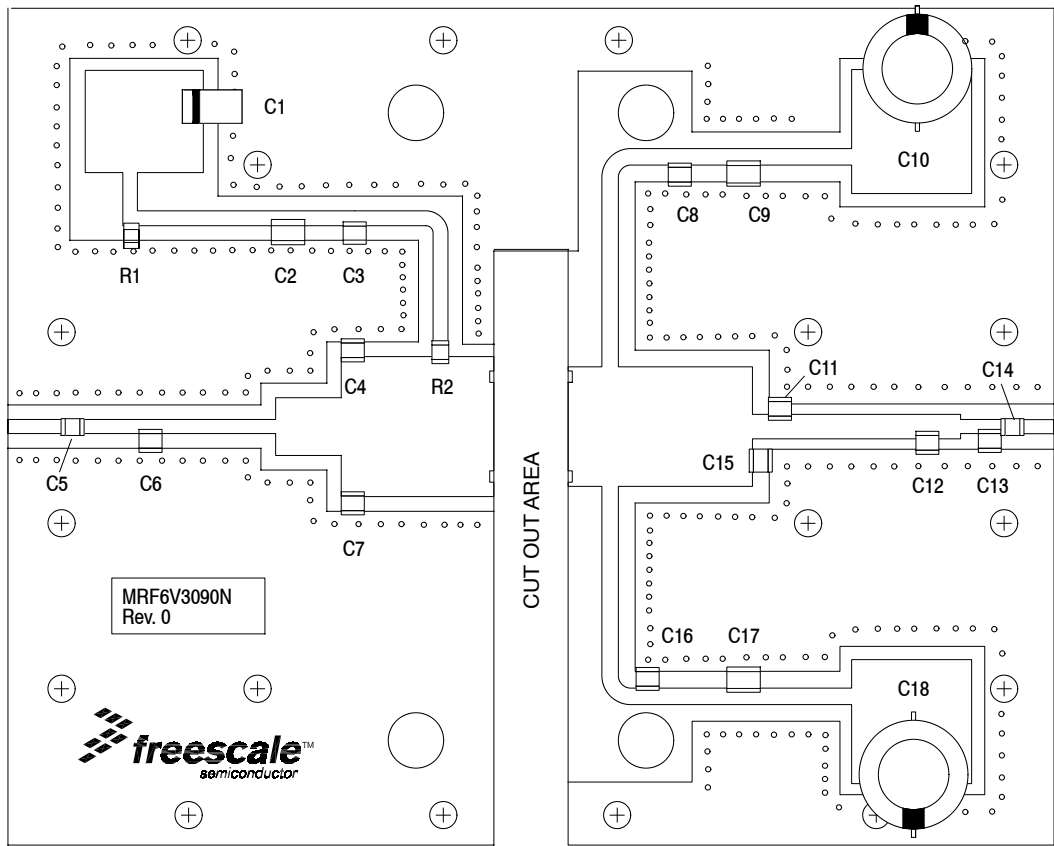

Figure 3. MRF6VP3091N 860 MHz Single-Ended Narrowband Test Circuit Component Layout

TYPICAL CHARACTERISTICS

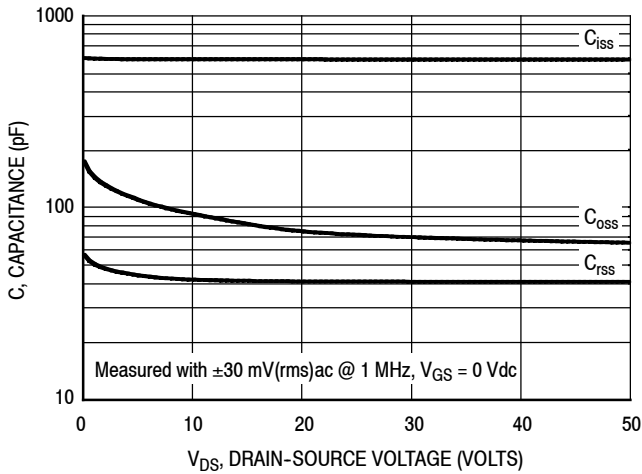

Figure 4. Capacitance versus Drain-Source Voltage

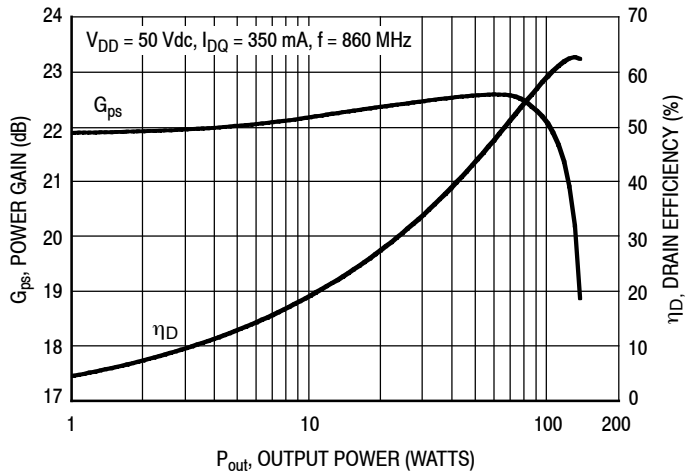

Figure 5. CW Power Gain and Drain Efficiency versus Output Power (Single-Ended Narrowband Test Circuit)

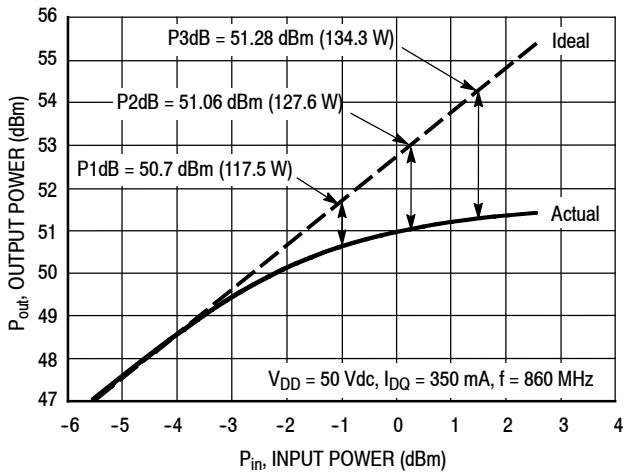

Figure 6. CW Output Power versus Input Power (Single-Ended Narrowband Test Circuit)

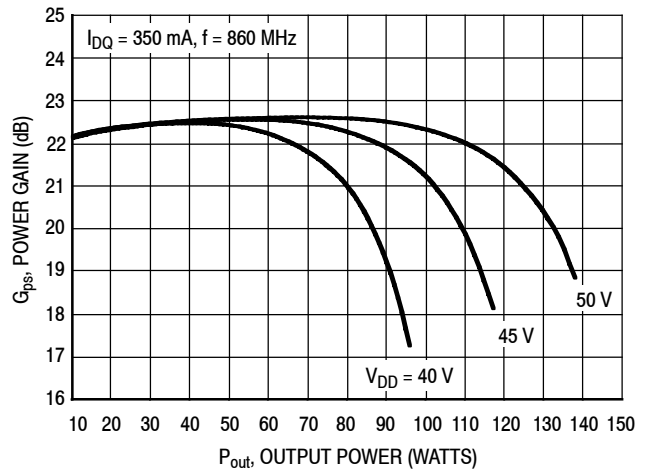

Figure 7. CW Power Gain versus Output Power (Single-Ended Narrowband Test Circuit)

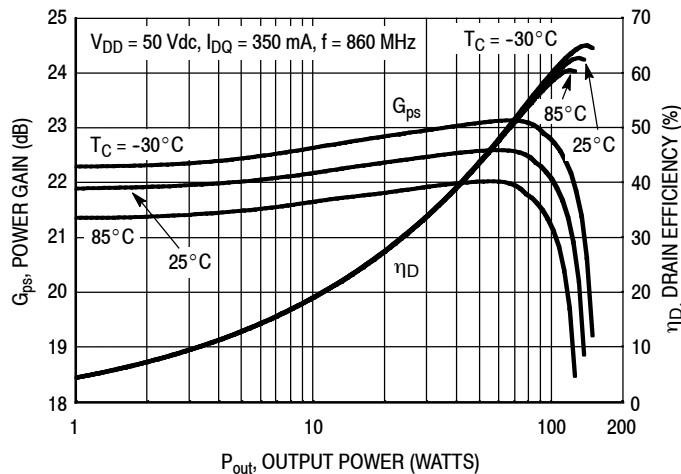

Figure 8. CW Power Gain and Drain Efficiency versus Output Power versus Temperature (Single-Ended Narrowband Test Circuit)

TYPICAL CHARACTERISTICS — TWO-TONE (SINGLE-ENDED NARROWBAND TEST CIRCUIT)

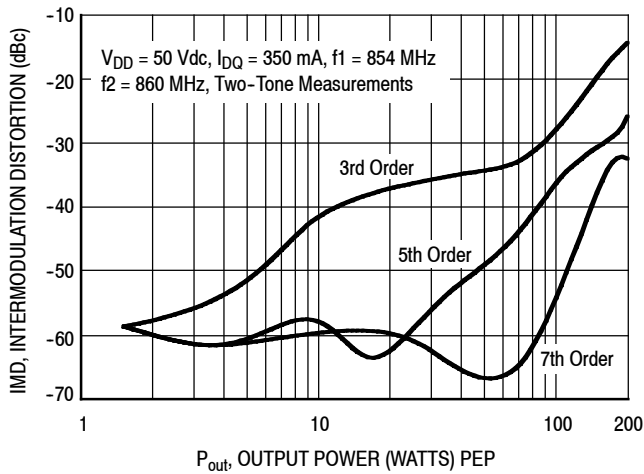

Figure 9. Intermodulation Distortion Products versus Output Power

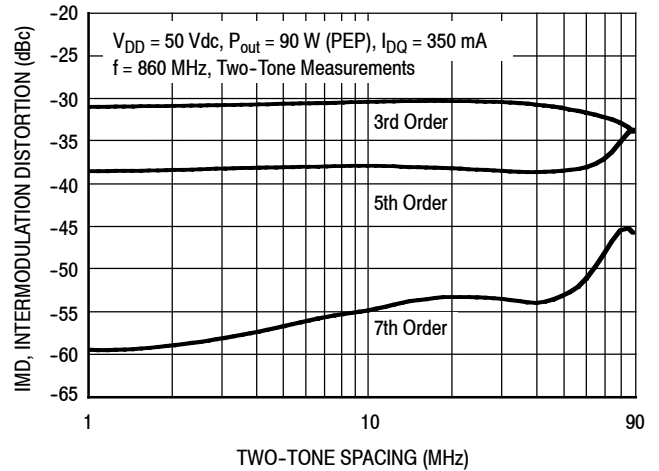

Figure 10. Intermodulation Distortion Products versus Two-Tone Spacing

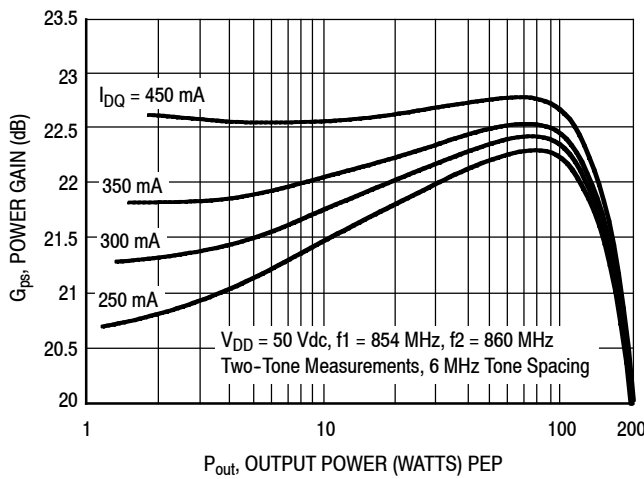

Figure 11. Two-Tone Power Gain versus Output Power

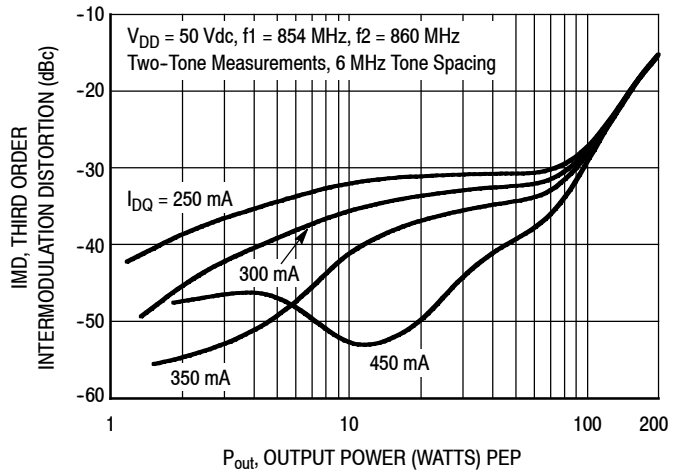

Figure 12. Third Order Intermodulation Distortion versus Output Power

TYPICAL CHARACTERISTICS — DVB-T (8k OFDM)

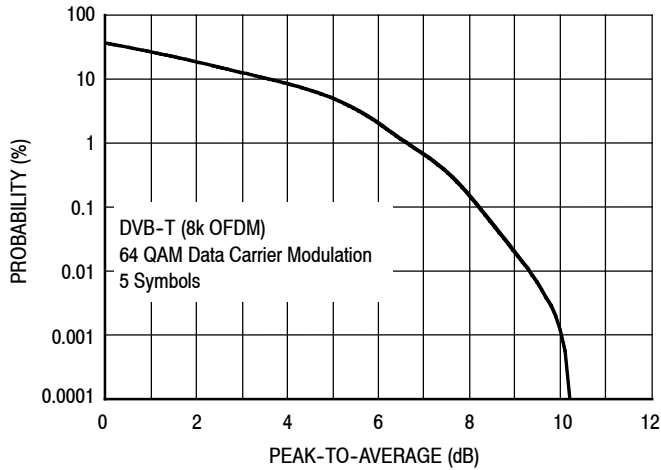

Figure 13. Single-Carrier DVB-T (8k OFDM)

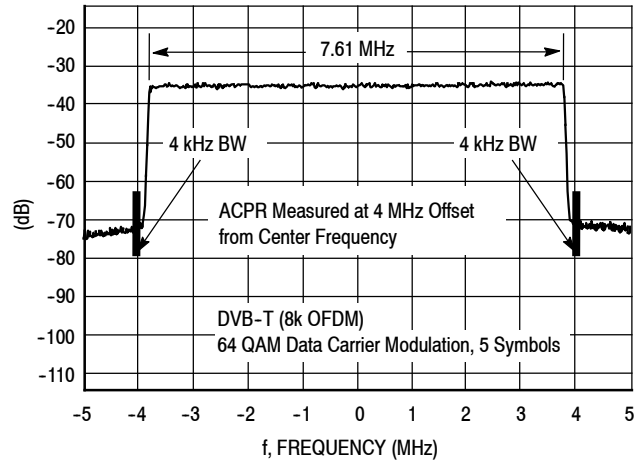

Figure 14. DVB-T (8k OFDM) Spectrum

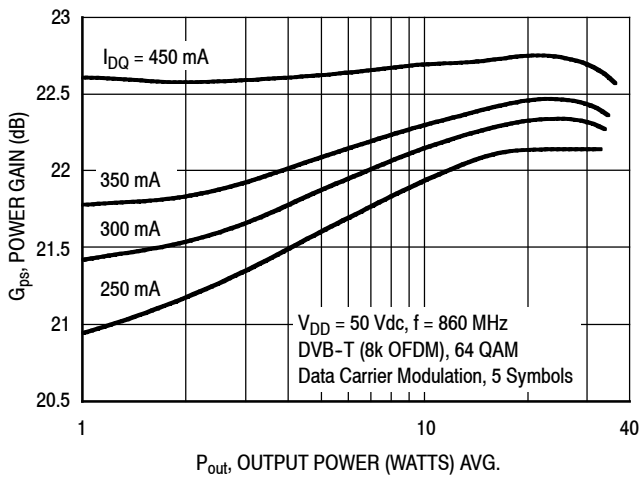

Figure 15. Single-Carrier DVB-T (8k OFDM) Power Gain versus Output Power (Single-Ended Narrowband Test Circuit)

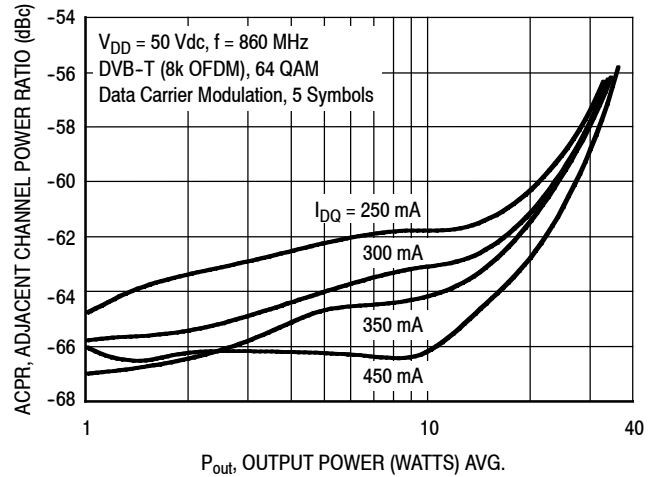

Figure 16. Single-Carrier DVB-T (8k OFDM) ACPR versus Output Power (Single-Ended Narrowband Test Circuit)

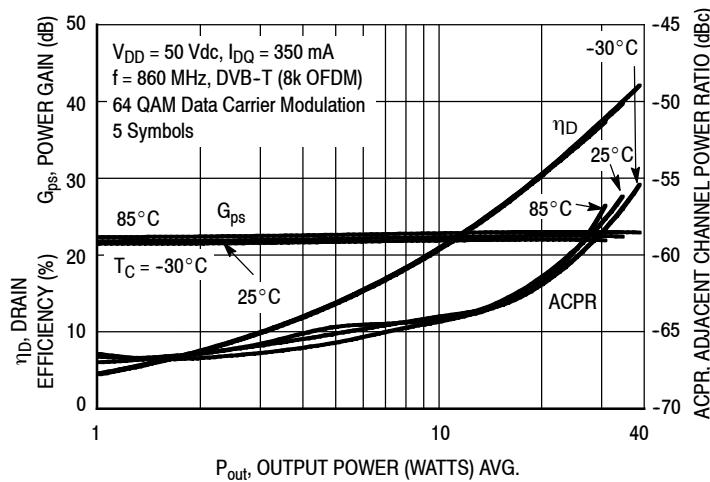
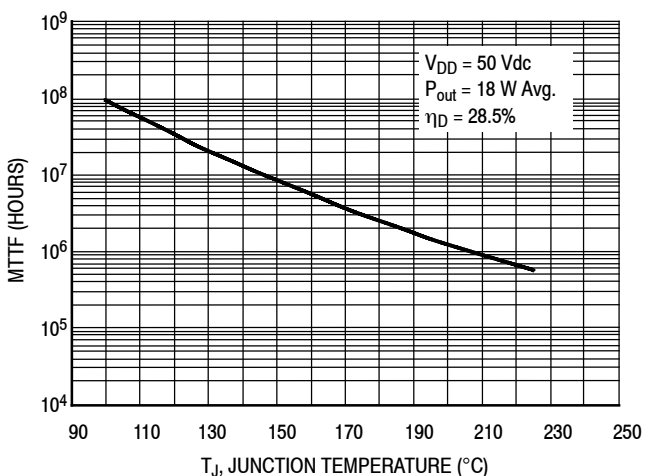

Figure 17. Single-Carrier DVB-T (8k OFDM) Drain Efficiency, Power Gain and ACPR versus Output Power versus Temperature (Single-Ended Narrowband Test Circuit)

TYPICAL CHARACTERISTICS



MTTF calculator available at <http://www.freescale.com/rf>. Select Software & Tools/Development Tools/Calculators to access MTTF calculators by product.

Figure 18. MTTF versus Junction Temperature - CW

$V_{DD} = 50 \text{ Vdc}$, $I_{DQ} = 350 \text{ mA}$, $P_{out} = 18 \text{ W Average}$

f MHz	Z_{source} Ω	Z_{load} Ω
860	$1.58 - j0.89$	$3.51 - j3.98$

Z_{source} = Test circuit impedance as measured from gate to ground.

Z_{load} = Test circuit impedance as measured from drain to ground.

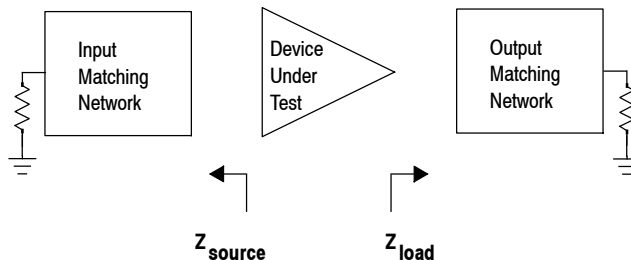
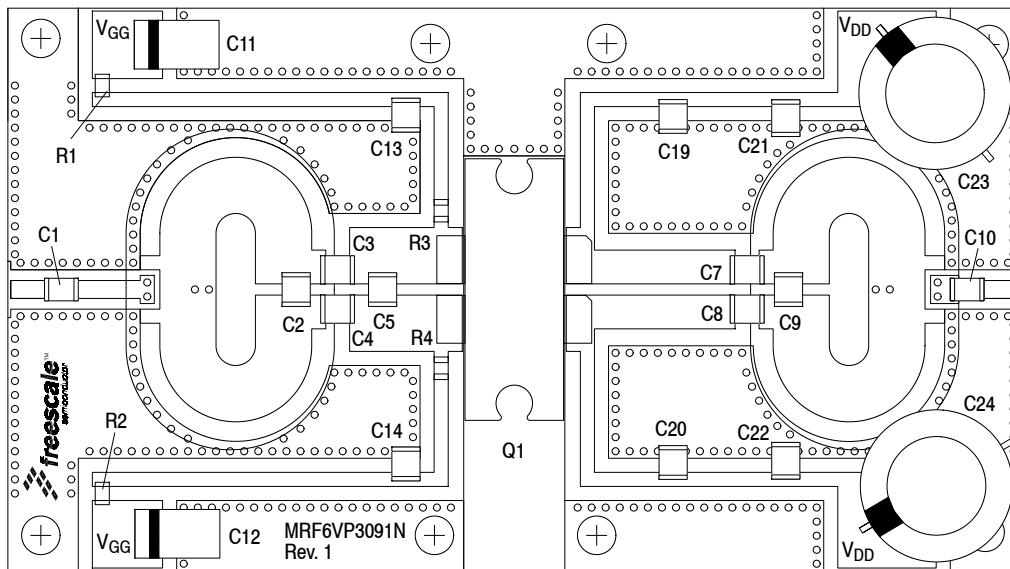

Figure 19. Series Equivalent Source and Load Impedance (Single-Ended Narrowband Test Circuit)

470-860 MHz BROADBAND REFERENCE CIRCUIT

$V_{DD} = 50$ Volts, $I_{DQ} = 450$ mA, Channel Bandwidth = 8 MHz, Input Signal PAR = 9.5 dB
@ 0.01% Probability on CCDF.

Signal Type	P_{out} (W)	f (MHz)	G_{ps} (dB)	η_D (%)	Output Signal PAR (dB)	IMD Shoulder (dBc)
DVB-T (8k OFDM)	4.5 Avg.	470	21.7	12.6	10.1	-40.1
		650	21.5	11.2	10.1	-43.1
		860	21.9	11.6	9.8	-46.0
	9 Avg.	470	21.8	20.3	9.9	-35.9
		650	21.6	17.5	9.9	-40.9
		860	21.9	18.5	9.1	-41.7
	18 Avg.	470	21.8	31.0	7.9	-27.8
		650	21.6	26.4	8.4	-37.6
		860	21.7	27.6	7.1	-30.4



Note: Component numbers C6, C15, C16, C17 and C18 are not used.

Figure 20. MRF6VP3091N 470-860 MHz Broadband 2" x 3.6" Compact Reference Circuit Component Layout

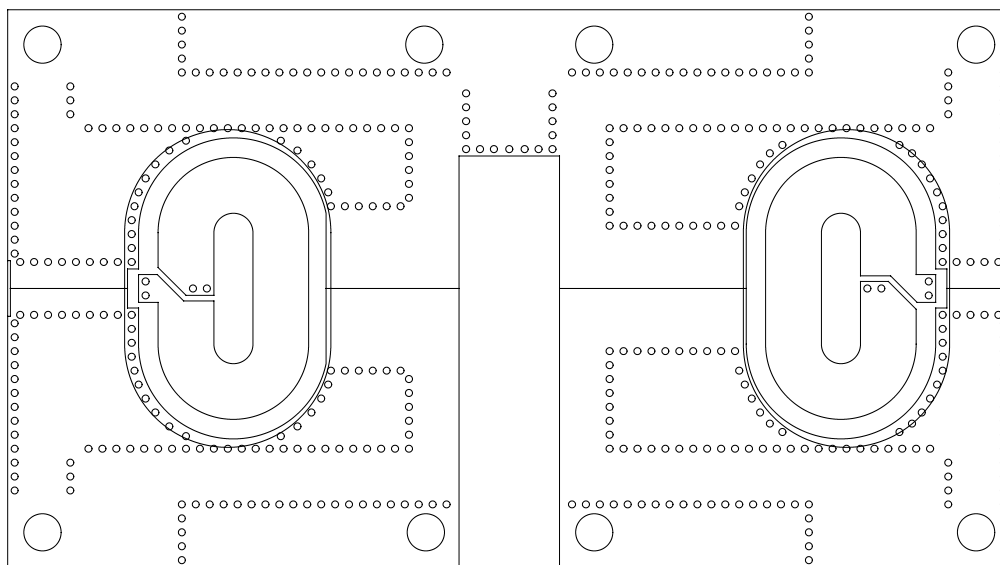
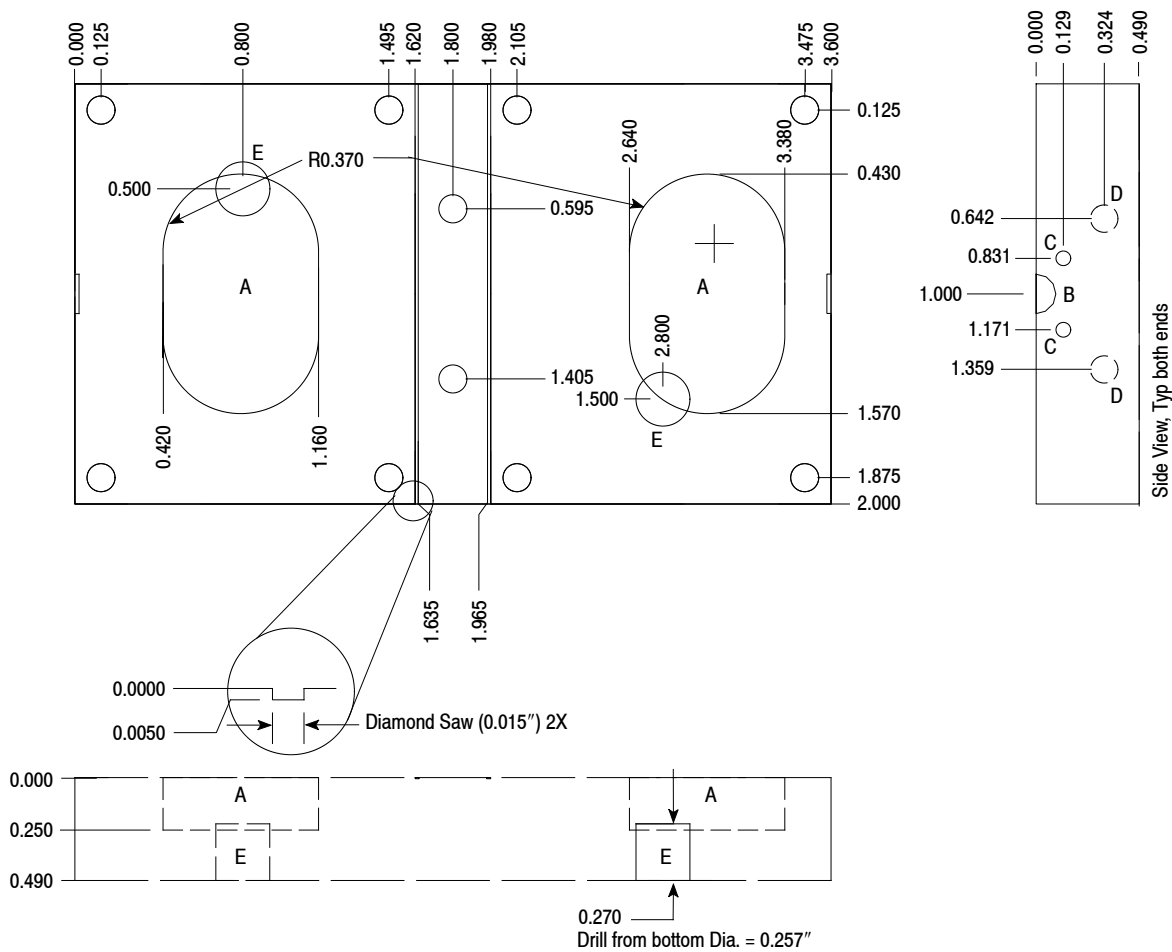

Figure 21. MRF6VP3091N 470-860 MHz Broadband 2" x 3.6" Compact Reference Circuit Component Layout — Bottom



T0-272 0.490" Copper Heatsink (for 30 mil 1 oz/1 oz PCB)

Designators	Details
A	2 places, mill down cavity 0.250"
B	2 places, on sides, 0.1875 diameter notch 0.020" deep (N connector notch)
C	4 places, side, drill & tap #2-56 screw 0.500" deep (SMA holes)
D	4 places, side, drill & tap #4-40 screw 0.500" deep (N conn holes)
E	2 places drill diameter = 0.257", from bottom depth = 0.270"
All others, drill through & tap for #4-40 screw	

Figure 22. MRF6VP3091N 470-860 MHz Broadband 2" x 3.6" Compact Reference Circuit Component Layout — Heatsink

Table 8. MRF6VP3091N 470-860 MHz Broadband 2" × 3.6" Compact Reference Circuit Component Designations and Values

Part	Description	Part Number	Manufacturer
C1, C3, C4, C7, C8, C10	51 pF Chip Capacitors	ATC100B510GT500XT	ATC
C2	7.5 pF Chip Capacitor	ATC100B7R5CT500XT	ATC
C5	4.7 pF Chip Capacitor	ATC100B4R7CT500XT	ATC
C9	5.6 pF Chip Capacitor	ATC100B5R6CT500XT	ATC
C11, C12	47 μ F, 16 V Tantalum Capacitors	T491D476K016AT	Kemet
C13, C14, C19, C20	200 pF Chip Capacitors	ATC100B201JT300XT	ATC
C21, C22	2.2 μ F, 100 V Chip Capacitors	C3225X7R2A225KT	TDK
C23, C24	470 μ F, 63 V Electrolytic Capacitors	MCGPR63V477M13X26-RH	Multicomp
Q1	RF High Power Transistor	MRF6VP3091NBR1	Freescale
R1, R2	10 Ω Chip Resistors	CRCW120610R0JNEA	Vishay
R3, R4	56 Ω Chip Resistors	CRCW120656R0FKEA	Vishay
PCB	0.030", $\epsilon_r = 3.5$	RO4350B	Rogers

TYPICAL CHARACTERISTICS — 470-860 MHz BROADBAND REFERENCE CIRCUIT

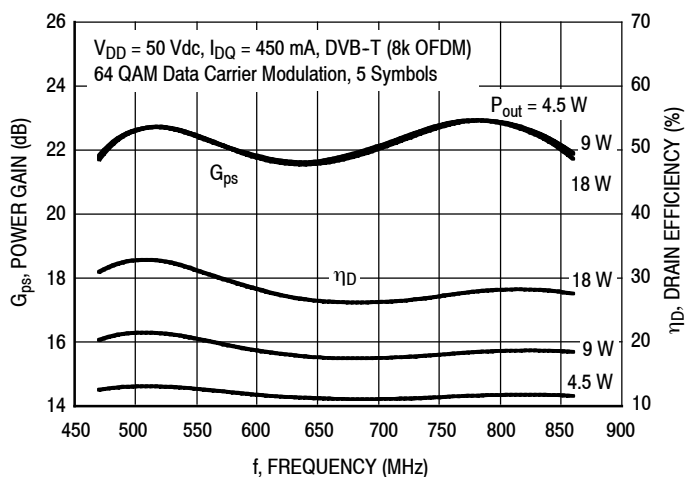
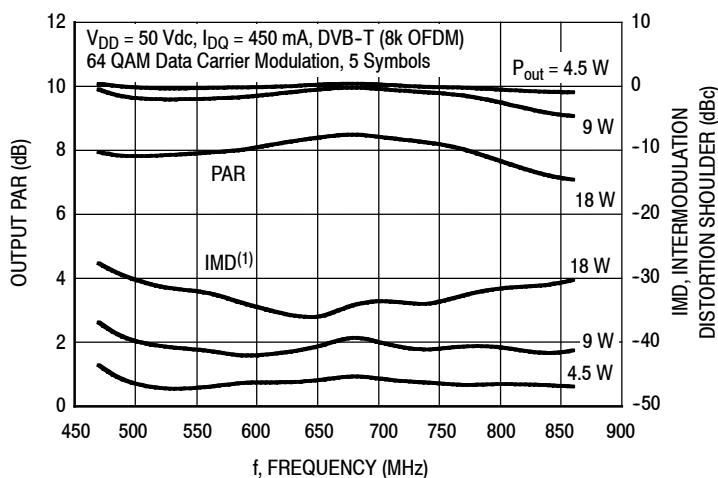

Figure 23. Single-Carrier DVB-T (8k OFDM) Power Gain and Drain Efficiency versus Frequency (Broadband Reference Circuit)



(1) Intermodulation distortion shoulder measurement made using delta marker at 4.2 MHz offset from center frequency.

Figure 24. Single-Carrier DVB-T (8k OFDM) Output PAR and IMD Shoulder versus Frequency (Broadband Reference Circuit)

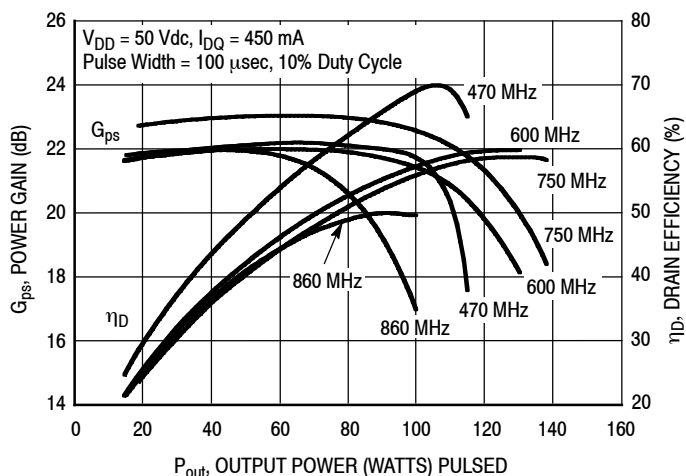
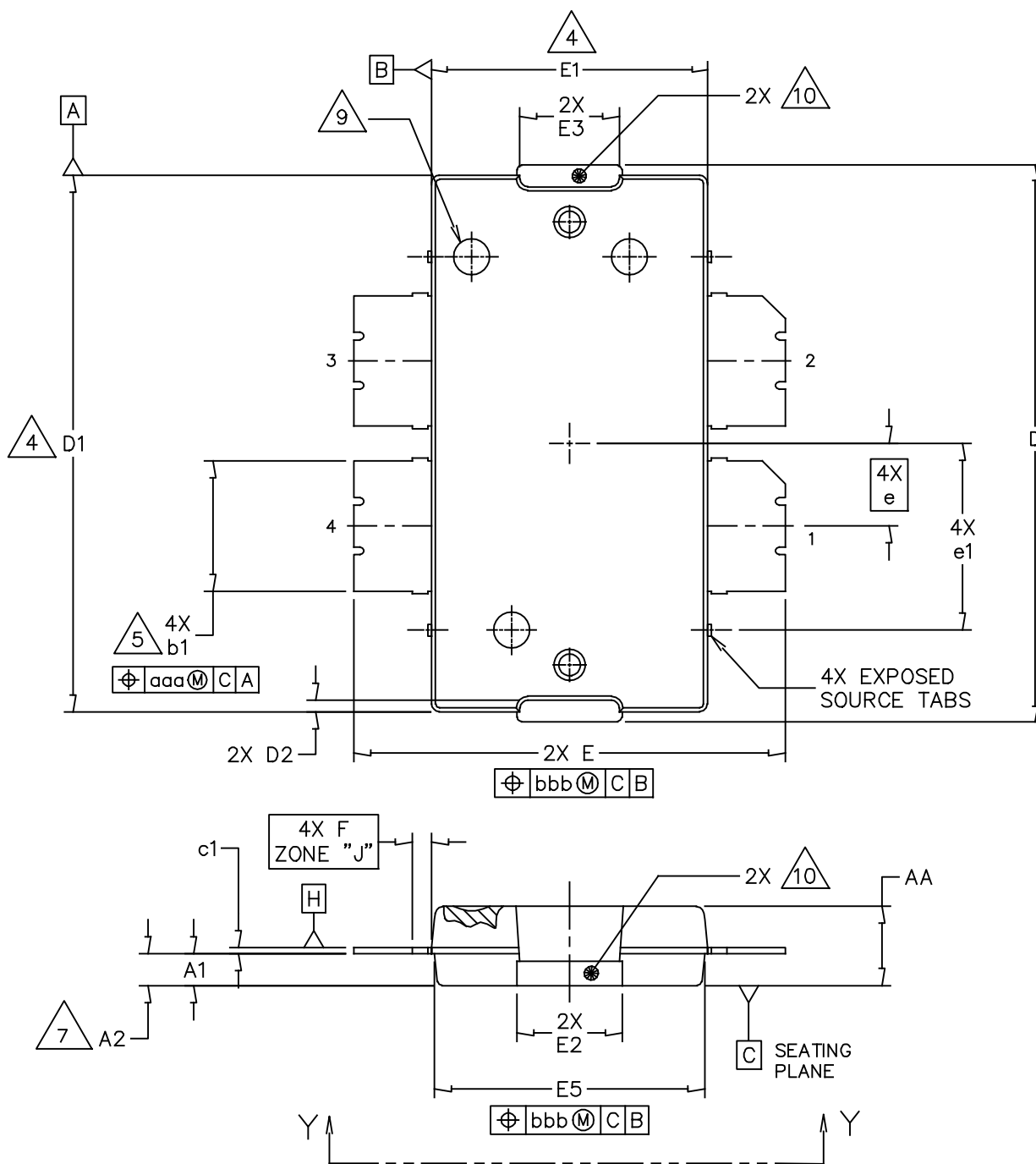
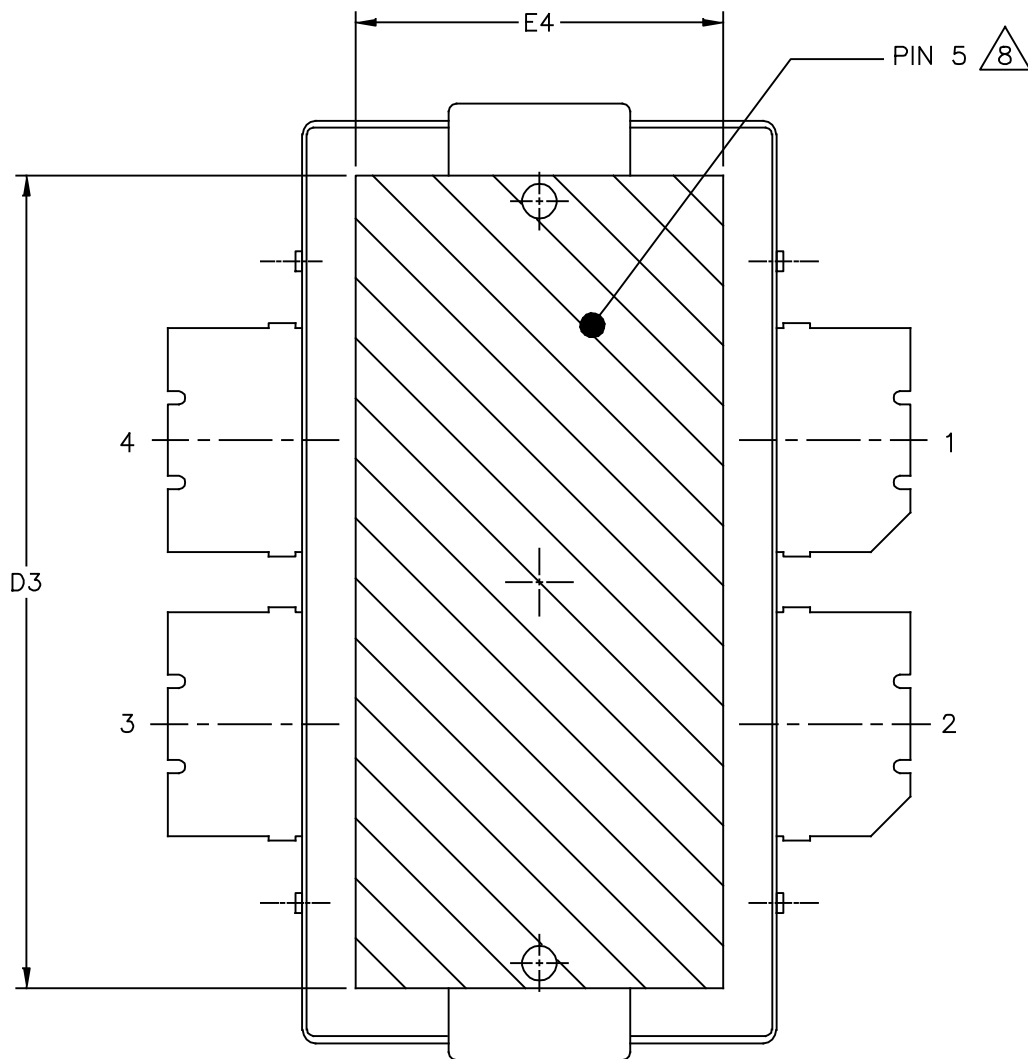

Figure 25. Pulsed Power Gain and Drain Efficiency versus Output Power (Broadband Reference Circuit)

PACKAGE DIMENSIONS



© FREESCALE SEMICONDUCTOR, INC. ALL RIGHTS RESERVED.	MECHANICAL OUTLINE	PRINT VERSION NOT TO SCALE
TITLE: TO-270WB-4	DOCUMENT NO: 98ASA10577D	REV: E
	STANDARD: NON-JEDEC	
	27 AUG 2013	



VIEW Y-Y

© FREESCALE SEMICONDUCTOR, INC. ALL RIGHTS RESERVED.	MECHANICAL OUTLINE	PRINT VERSION NOT TO SCALE
TITLE: TO-270WB-4	DOCUMENT NO: 98ASA10577D	REV: E
	STANDARD: NON-JEDEC	
	27 AUG 2013	

NOTES:

1. CONTROLLING DIMENSION: INCH
2. INTERPRET DIMENSIONS AND TOLERANCES PER ASME Y14.5M-1994.
3. DATUM PLANE H IS LOCATED AT THE TOP OF LEAD AND IS COINCIDENT WITH THE LEAD WHERE THE LEAD EXITS THE PLASTIC BODY AT THE TOP OF THE PARTING LINE.
4. DIMENSIONS D1 AND E1 DO NOT INCLUDE MOLD PROTRUSION. ALLOWABLE PROTRUSION IS .006 INCH (0.15MM) PER SIDE. DIMENSIONS D1 AND E1 DO INCLUDE MOLD MISMATCH AND ARE DETERMINED AT DATUM PLANE H.
5. DIMENSIONS b1 DOES NOT INCLUDE DAMBAR PROTRUSION. ALLOWABLE DAMBAR PROTRUSION SHALL BE .005 INCH (0.13MM) TOTAL IN EXCESS OF THE b1 DIMENSION AT MAXIMUM MATERIAL CONDITION.
6. DATUMS A AND B TO BE DETERMINED AT DATUM PLANE H.
7. DIMENSION A2 APPLIES WITHIN ZONE J ONLY.
8. HATCHING REPRESENTS THE EXPOSED AREA OF THE HEAT SLUG. DIMENSIONS D3 AND D4 REPRESENT THE VALUES BETWEEN THE TWO OPPOSITE POINTS ALONG THE EDGES OF EXPOSED AREA OF HEAT SLUG.
9. DIMPLED HOLE REPRESENTS INPUT SIDE.
10. THESE SURFACES OF THE HEAT SLUG ARE NOT PART OF THE SOLDERABLE SURFACES AND MAY REMAIN UNPLATED.

DIM	INCH		MILLIMETER		DIM	INCH		MILLIMETER	
	MIN	MAX	MIN	MAX		MIN	MAX	MIN	MAX
AA	.100	.104	2.54	2.64	F	.025 BSC		0.64 BSC	
A1	.039	.043	0.99	1.09	b1	.164	.170	4.17	4.32
A2	.040	.042	1.02	1.07	c1	.007	.011	0.18	0.28
D	.712	.720	18.08	18.29	e	.106 BSC		2.69 BSC	
D1	.688	.692	17.48	17.58	e1	.239 INFO ONLY		6.07 INFO ONLY	
D2	.011	.019	0.28	0.48	aaa	.004		0.10	
D3	.600	---	15.24	---	bbb	.008		0.20	
E	.551	.559	14.00	14.20					
E1	.353	.357	8.97	9.07					
E2	.132	.140	3.35	3.56					
E3	.124	.132	3.15	3.35					
E4	.270	---	6.86	---					
E5	.346	.350	8.79	8.89					
© FREESCALE SEMICONDUCTOR, INC. ALL RIGHTS RESERVED.			MECHANICAL OUTLINE			PRINT VERSION NOT TO SCALE			
TITLE: TO-270WB-4					DOCUMENT NO: 98ASA10577D REV: E				
					STANDARD: NON-JEDEC				
					27 AUG 2013				

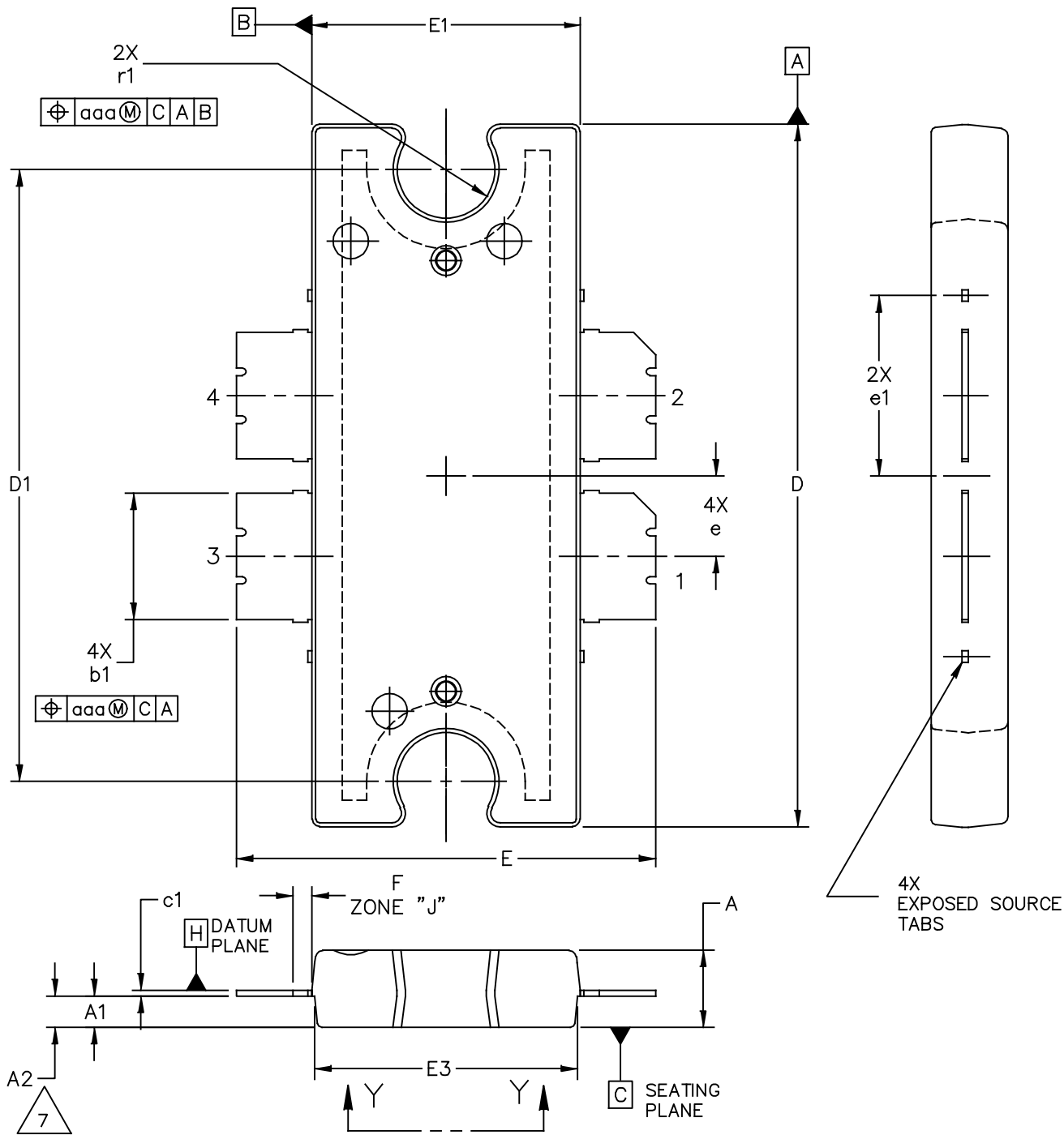

© FREESCALE SEMICONDUCTOR, INC. ALL RIGHTS RESERVED.		MECHANICAL OUTLINE		PRINT VERSION NOT TO SCALE	
TITLE: TO-272 4 LEAD, WIDE BODY			DOCUMENT NO: 98ASA10575D		REV: E
			CASE NUMBER: 1484-04		31 AUG 2007
			STANDARD: NON-JEDEC		

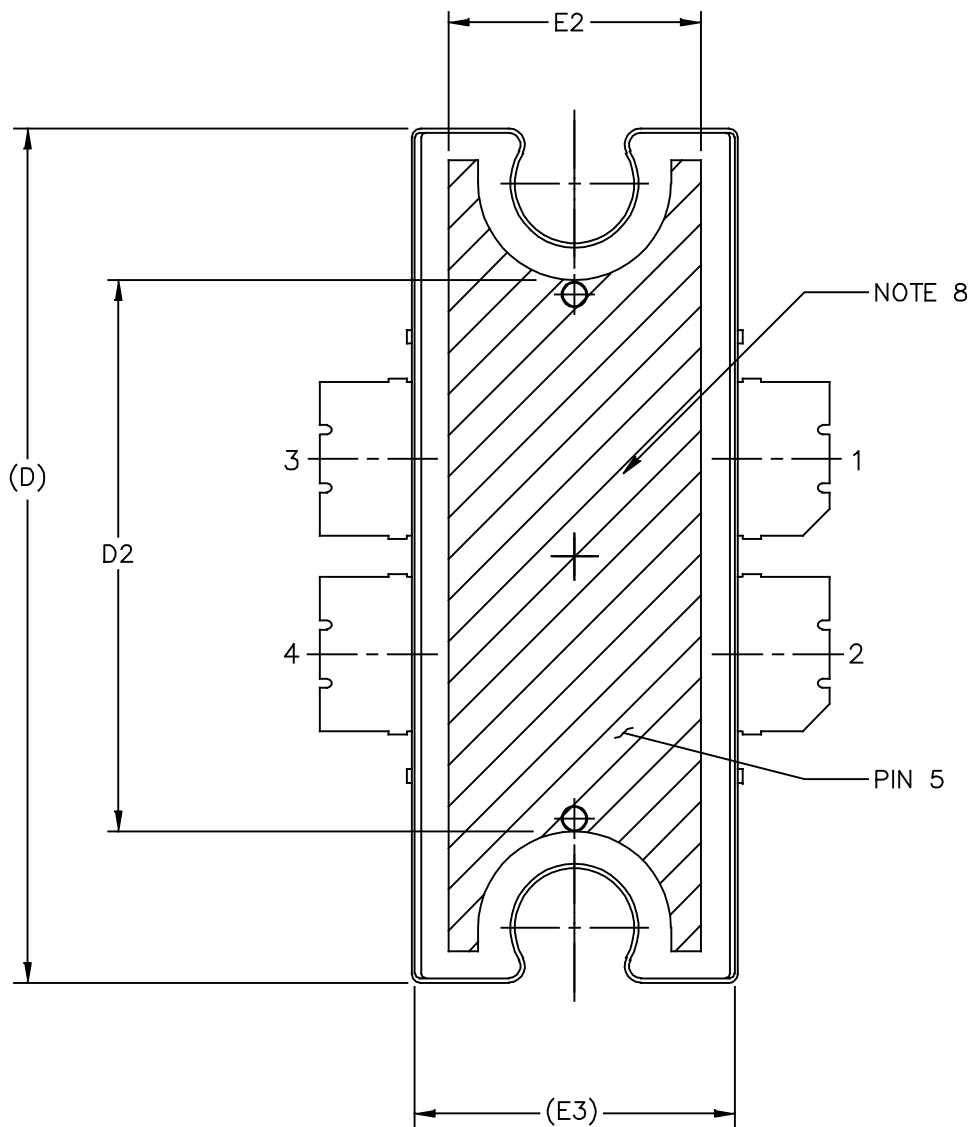

© FREESCALE SEMICONDUCTOR, INC. ALL RIGHTS RESERVED.	MECHANICAL OUTLINE	PRINT VERSION NOT TO SCALE	
TITLE: TO-272 4 LEAD, WIDE BODY	DOCUMENT NO: 98ASA10575D	REV: E	
	CASE NUMBER: 1484-04	31 AUG 2007	
	STANDARD: NON-JEDEC		

NOTES:

1. CONTROLLING DIMENSION: INCH
2. INTERPRET DIMENSIONS AND TOLERANCES PER ASME Y14.5M-1994.
3. DATUM PLANE H IS LOCATED AT THE TOP OF LEAD AND IS COINCIDENT WITH THE LEAD WHERE THE LEAD EXITS THE PLASTIC BODY AT THE TOP OF THE PARTING LINE.
4. DIMENSIONS "D" AND "E1" DO NOT INCLUDE MOLD PROTRUSION. ALLOWABLE PROTRUSION IS .006 PER SIDE. DIMENSIONS "D" AND "E1" DO INCLUDE MOLD MISMATCH AND ARE DETERMINED AT DATUM PLANE H.
5. DIMENSIONS "b1" DOES NOT INCLUDE DAMBAR PROTRUSION. ALLOWABLE DAMBAR PROTRUSION SHALL BE .005 TOTAL IN EXCESS OF THE "b1" DIMENSION AT MAXIMUM MATERIAL CONDITION.
6. DATUM A AND B TO BE DETERMINED AT DATUM PLANE H.
7. DIMENSION A2 APPLIES WITHIN ZONE "J" ONLY.
8. HATCHING REPRESENTS EXPOSED AREA OF THE HEAT SLUG. HATCHED AREA SHOWN IS ON THE SAME PLANE.

STYLE 1:

PIN 1 - DRAIN PIN 2 - DRAIN
 PIN 3 - GATE PIN 4 - GATE
 PIN 5 - SOURCE

DIM	INCH		MILLIMETER		DIM	INCH		MILLIMETER	
	MIN	MAX	MIN	MAX		MIN	MAX	MIN	MAX
A	.100	.104	2.54	2.64	b1	.164	.170	4.17	4.32
A1	.039	.043	0.99	1.09	c1	.007	.011	.18	.28
A2	.040	.042	1.02	1.07	r1	.063	.068	1.60	1.73
D	.928	.932	23.57	23.67	e	.106 BSC		2.69 BSC	
D1	.810 BSC		20.57 BSC		e1	.239 INFO ONLY		6.07 INFO ONLY	
D2	.600	---	15.24	---	aaa	.004		.10	
E	.551	.559	14	14.2					
E1	.353	.357	8.97	9.07					
E2	.270	---	6.86	---					
E3	.346	.350	8.79	8.89					
F	.025 BSC		0.64 BSC						

© FREESCALE SEMICONDUCTOR, INC. ALL RIGHTS RESERVED.		MECHANICAL OUTLINE		PRINT VERSION NOT TO SCALE	
TITLE: TO-272 4 LEAD WIDE BODY			DOCUMENT NO: 98ASA10575D		REV: E
			CASE NUMBER: 1484-04		31 AUG 2007
			STANDARD: NON-JEDEC		

PRODUCT DOCUMENTATION, TOOLS AND SOFTWARE

Refer to the following documents, tools and software to aid your design process.

Application Notes

- AN1907: Solder Reflow Attach Method for High Power RF Devices in Over-Molded Plastic Packages
- AN1955: Thermal Measurement Methodology of RF Power Amplifiers
- AN3263: Bolt Down Mounting Method for High Power RF Transistors and RFICs in Over-Molded Plastic Packages
- AN3789: Clamping of High Power RF Transistors and RFICs in Over-Molded Plastic Packages

Engineering Bulletins

- EB212: Using Data Sheet Impedances for RF LDMOS Devices

Software

- Electromigration MTTF Calculator
- RF High Power Model
- .s2p File

For Software and Tools, do a Part Number search at <http://www.freescale.com>, and select the “Part Number” link. Go to the Software & Tools tab on the part’s Product Summary page to download the respective tool.

REVISION HISTORY

The following table summarizes revisions to this document.

Revision	Date	Description
0	Sept. 2011	<ul style="list-style-type: none"> • Initial Release of Data Sheet
1	Dec. 2011	<ul style="list-style-type: none"> • Added R5 part numbers MRF6VP3091NR5 and MRF6VP3091NBR5, p. 1 • Fig. 7, CW Power Gain versus Output Power (Single-Ended Narrowband Test Circuit): adjusted x-axis scale from 0 to 140 watts to 10 to 150 watts, p. 5 • Fig. 10, Intermodulation Distortion Products versus Two-Tone Spacing: added $f = 860$ MHz to graph callouts, p. 6 • Added Fig. 21, 470–860 MHz Broadband 2" × 3.6" Compact Reference Circuit Component Layout - 470–860 MHz - Bottom, p. 10 • Added Fig. 22, 470–860 MHz Broadband 2" × 3.6" Compact Reference Circuit Component Layout - 470–860 MHz - Heatsink, p. 10
2	Oct. 2015	<ul style="list-style-type: none"> • Added L-Band 960–1215 MHz performance data, p. 1 • Replaced Case Outline TO-270WB-4 Issue D with Issue E, p. 1, 14–16. Added notes 9 and 10, four exposed source tabs, and a feature control frame to E and E5 on p. 14. Removed style and pin information from notes section on p. 16.

How to Reach Us:

Home Page:
freescale.com

Web Support:
freescale.com/support

Information in this document is provided solely to enable system and software implementers to use Freescale products. There are no express or implied copyright licenses granted hereunder to design or fabricate any integrated circuits based on the information in this document.

Freescale reserves the right to make changes without further notice to any products herein. Freescale makes no warranty, representation, or guarantee regarding the suitability of its products for any particular purpose, nor does Freescale assume any liability arising out of the application or use of any product or circuit, and specifically disclaims any and all liability, including without limitation consequential or incidental damages. "Typical" parameters that may be provided in Freescale data sheets and/or specifications can and do vary in different applications, and actual performance may vary over time. All operating parameters, including "typicals," must be validated for each customer application by customer's technical experts. Freescale does not convey any license under its patent rights nor the rights of others. Freescale sells products pursuant to standard terms and conditions of sale, which can be found at the following address: freescale.com/SalesTermsandConditions.

Freescale and the Freescale logo are trademarks of Freescale Semiconductor, Inc., Reg. U.S. Pat. & Tm. Off. All other product or service names are the property of their respective owners.

© 2011, 2015 Freescale Semiconductor, Inc.

Mouser Electronics

Authorized Distributor

Click to View Pricing, Inventory, Delivery & Lifecycle Information:

[NXP:](#)

[MRF6VP3091NBR1](#) [MRF6VP3091NR1](#) [MRF6VP3091NBR5](#) [MRF6VP3091NR5](#)