

THIS DRAWING IS UNPUBLISHED.

RELEASED FOR PUBLICATION

© COPYRIGHT -

ALL RIGHTS RESERVED.

LOC	DIST
-	-

REVISIONS

P	LTR	DESCRIPTION	DATE	DWN	APVD
A		INITIAL RELEASE	08AUG2014	PS	JK

REFERENCE MATING INTERFACE PATTERN:  
1,27 STAGGERED PITCH x 1,5 ROW-DISTANCE.

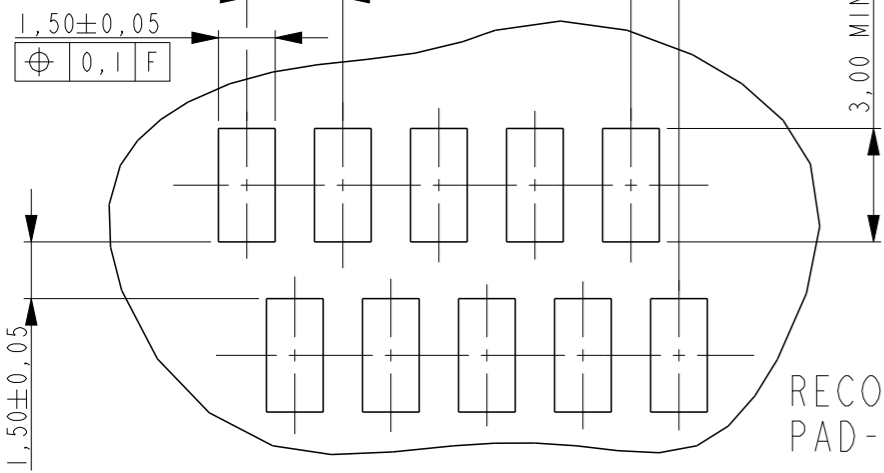
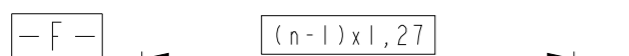
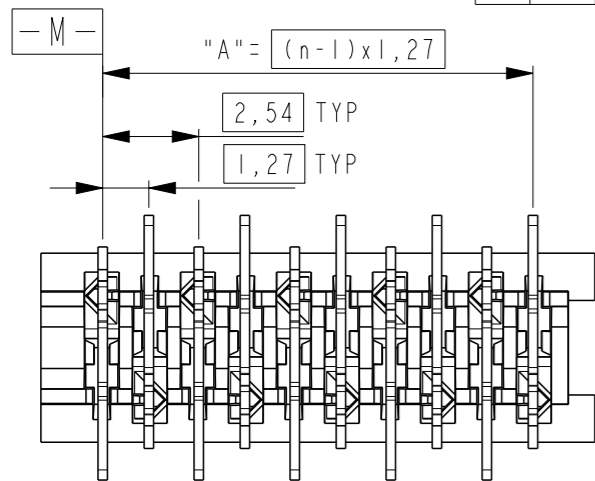
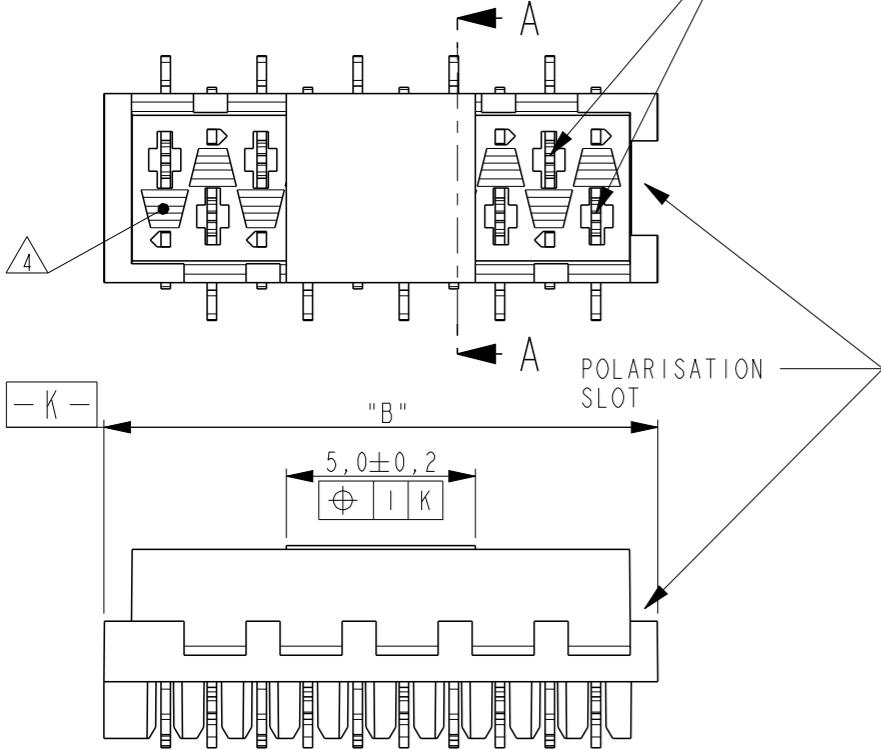

RECOMMENDED PC-BOARD  
PAD-LAYOUT TOP VIEW

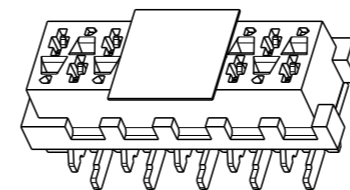
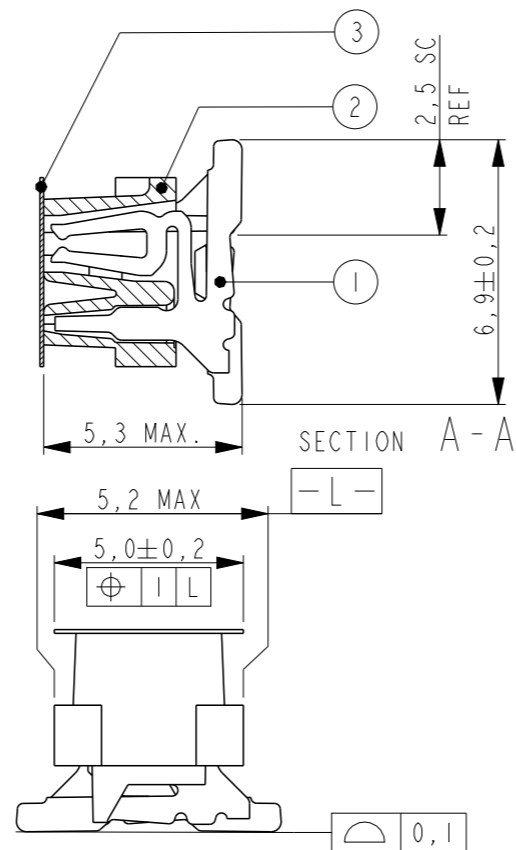

SCALE 3:1

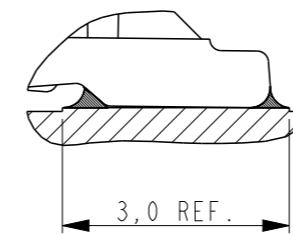

SOLDER DETAIL  
SCALE 10:1

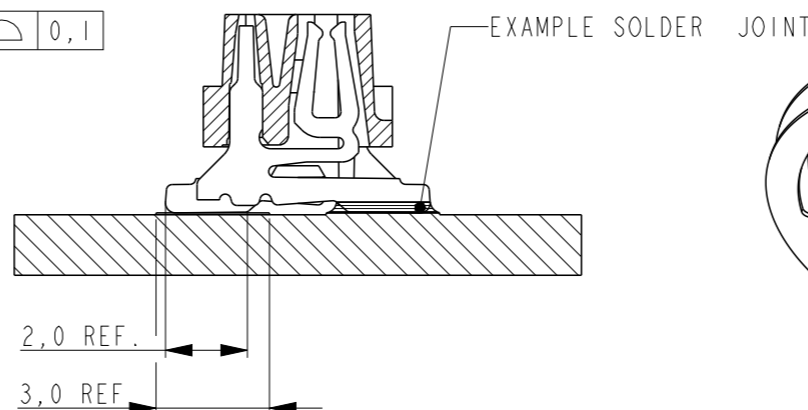

△1 PARTNUMBER VAC. TAPE.	△3 PARTNUMBER	NO. OF POS. "n"	"A"	"B" MAX.
7-2178711-4	2178711-4	4	3,81	7,1
7-2178711-6	2178711-6	6	6,35	9,7
7-2178711-8	2178711-8	8	8,89	12,2
8-2178711-0	1-2178711-0	10	11,43	14,7
8-2178711-2	1-2178711-2	12	13,97	17,3
8-2178711-4	1-2178711-4	14	16,51	19,8
8-2178711-6	1-2178711-6	16	19,05	22,4
8-2178711-8	1-2178711-8	18	21,59	24,9
9-2178711-0	2-2178711-0	20	24,13	27,5

NOTES:

- △1 TAPE FOR VACUUM P&P ONLY FOR DASHNUMBERS 7- /8- /9-
- 2 FOR PACKAGING SEE SHEET 2 OF 2
- △3 WITHOUT VACUUM TAPE.
- △4 CORING-OUTS FOR MANUFACTURING PURPOSE ONLY.  
SHAPE MAY VARY, BUT IS NOT FUNCTIONAL FOR THE APPLICATION.
- 5 SHOWN IS A 10 POSITION CONNECTOR.

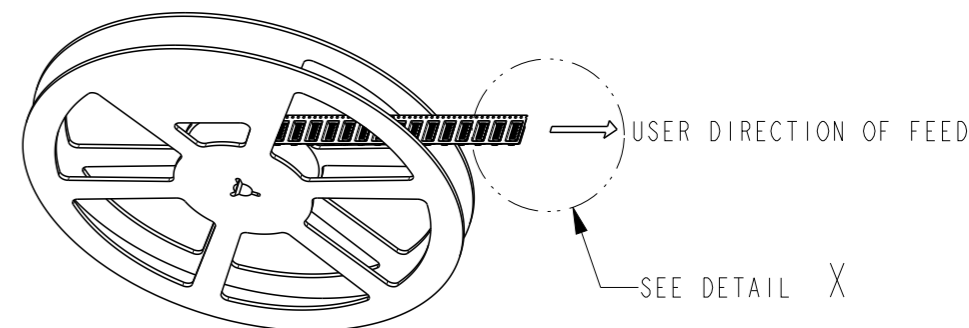

ACCORDING EIA-481/DIN IEC 286

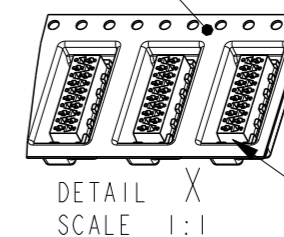

ITEM NO.	COMPONENT DESCRIPTION	MATERIAL	FINISH / COLOR
3	PICK & PLACE TAPE	KAPTON	AMBER TRANSPARENT
2	FEMALE HOUSING	POLYAMIDE 4/6,GF	BLACK
1	FEMALE CONTACT	TIN BRASS	3.0 - 5.0µm TIN OVER 0.5µm NICKEL

THIS DRAWING IS A CONTROLLED DOCUMENT.		DWN 30JUL2014 PRASHANTH		 TE Connectivity	
DIMENSIONS: mm		CHK 05AUG2014 PRASHANTH			
TOLERANCES UNLESS OTHERWISE SPECIFIED:		APVD 05AUG2014 JAYANTH KUMAR		NAME Micro-MaTch VALUE LINE FEMALE-ON-BOARD, TOP ENTRY, SMD, CONNECTOR	
0 PLC ±-		PRODUCT SPEC 108-32087		SIZE A3	
1 PLC ±-		APPLICATION SPEC 114-13318		CAGE CODE 00779	
2 PLC ±-		WEIGHT -		DRAWING NO C-2178711	
3 PLC ±-		CUSTOMER DRAWING		RESTRICTED TO -	
4 PLC ±-		SCALE 5:1		SHEET 1 OF 2	
ANGLES ±-		REV A			
FINISH SEE TABLE					

THIS DRAWING IS UNPUBLISHED.

RELEASED FOR PUBLICATION

© COPYRIGHT -

ALL RIGHTS RESERVED.

LOC	DIST	REVISIONS					
		P	LTR	DESCRIPTION	DATE	DWN	APVD
-	-			SEE SHEET 1			

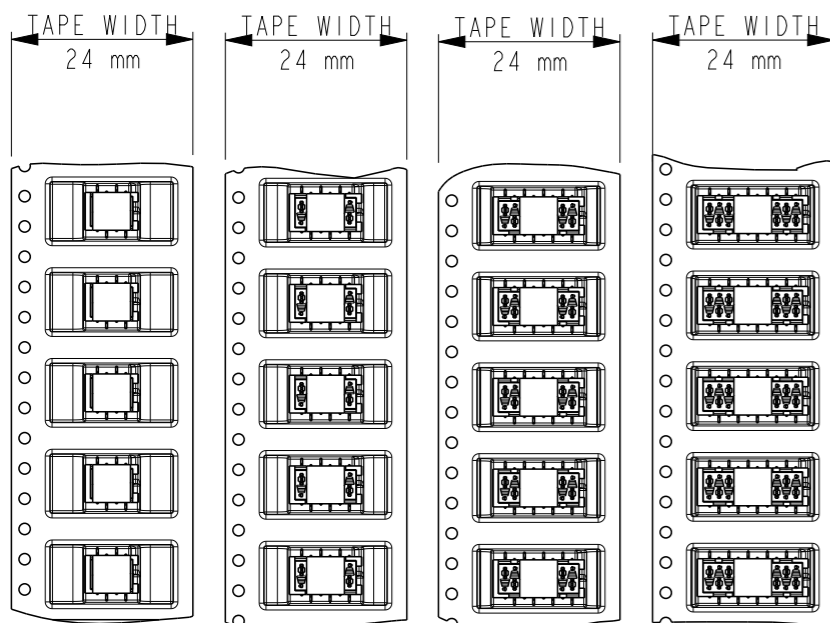

7-2178711-4	7-2178711-6	7-2178711-8	8-2178711-0
4 POSITION	6 POSITION	8 POSITION	10 POSITION
2178711-4	2178711-6	2178711-8	1-2178711-0

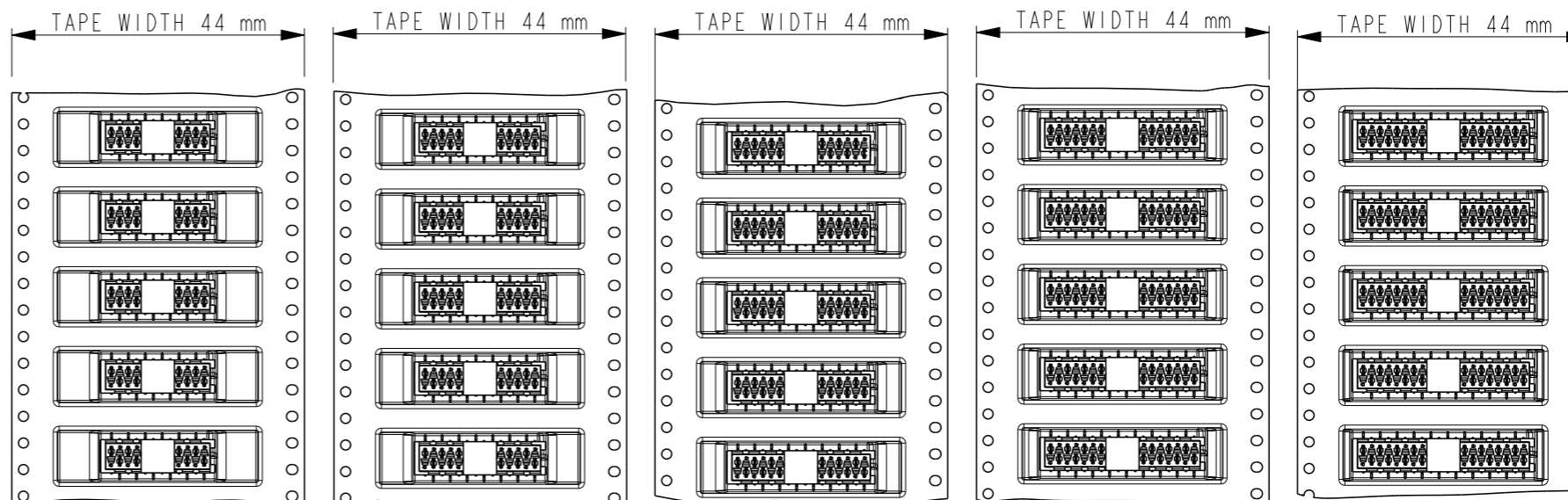
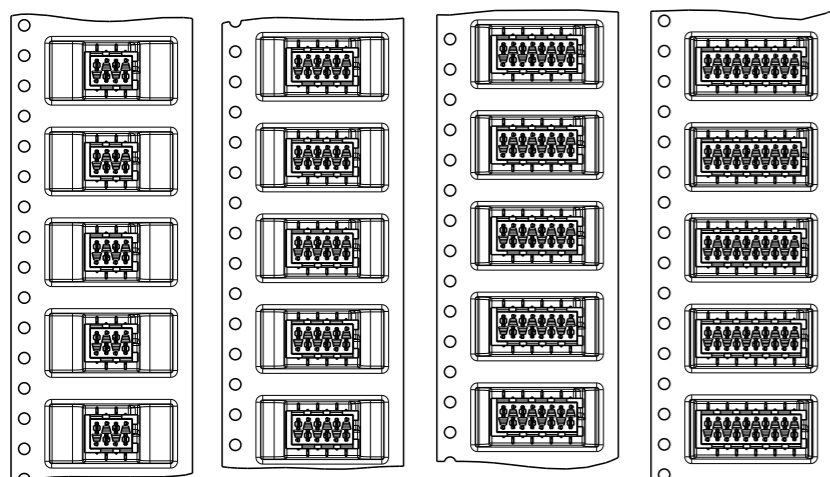

8-2178711-2	8-2178711-4	8-2178711-6	8-2178711-8	9-2178711-0
12 POSITION	14 POSITION	16 POSITION	18 POSITION	20 POSITION
1-2178711-2	1-2178711-4	1-2178711-6	1-2178711-8	2-2178711-0

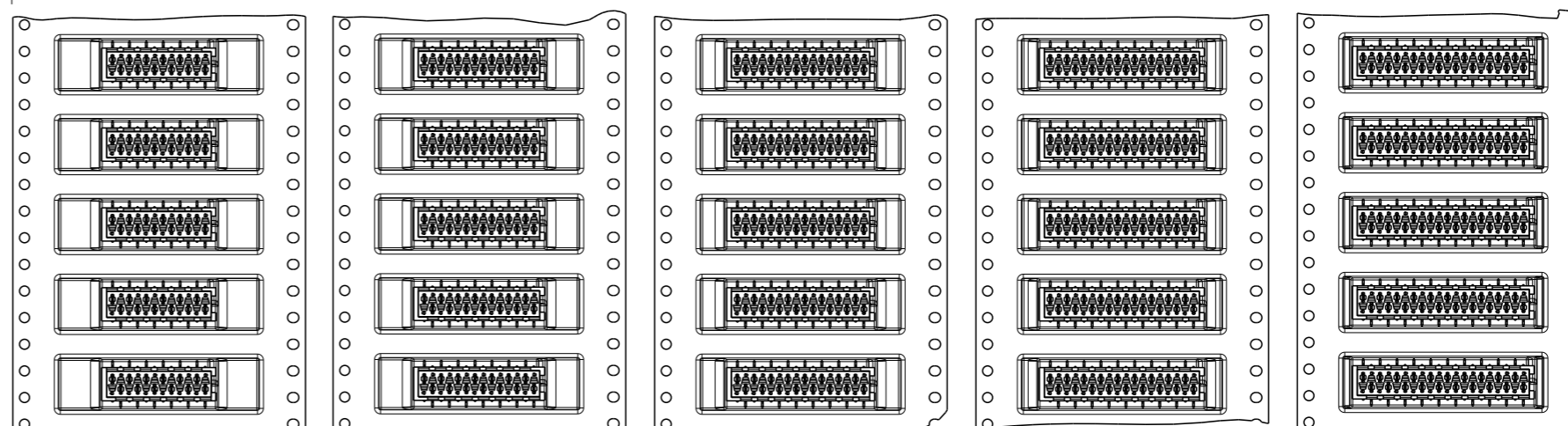

THIS DRAWING IS A CONTROLLED DOCUMENT.

DIMENSIONS:  
mm

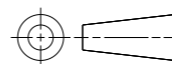

TOLERANCES UNLESS OTHERWISE SPECIFIED:

- 0 PLC ±-
- 1 PLC ±0.1
- 2 PLC ±0.05
- 3 PLC ±-
- 4 PLC ±-
- ANGLES ±-
- FINISH -

MATERIAL -

DWN 25JUL2014  
PRASHANTH  
CHK 05AUG2014  
PRASHANTH  
APVD 05AUG2014  
JAYANTH KUMAR  
PRODUCT SPEC  
108-32087  
APPLICATION SPEC  
114-13318  
WEIGHT -

CUSTOMER DRAWING



NAME  
Micro-MaTch VALUE LINE  
FEMALE-ON-BOARD, TOP ENTRY,  
SMD, CONNECTOR

SIZE	CAGE CODE	DRAWING NO	RESTRICTED TO
A3	00779	©-2178711	-

SCALE 1:1 SHEET 2 OF 2 REV A

# Mouser Electronics

Authorized Distributor

Click to View Pricing, Inventory, Delivery & Lifecycle Information:

[TE Connectivity:](#)

[2-2178711-0](#)