

DESCRIPTION: POWER / SIGNAL - RIGHT ANGLE - MALE - IP67

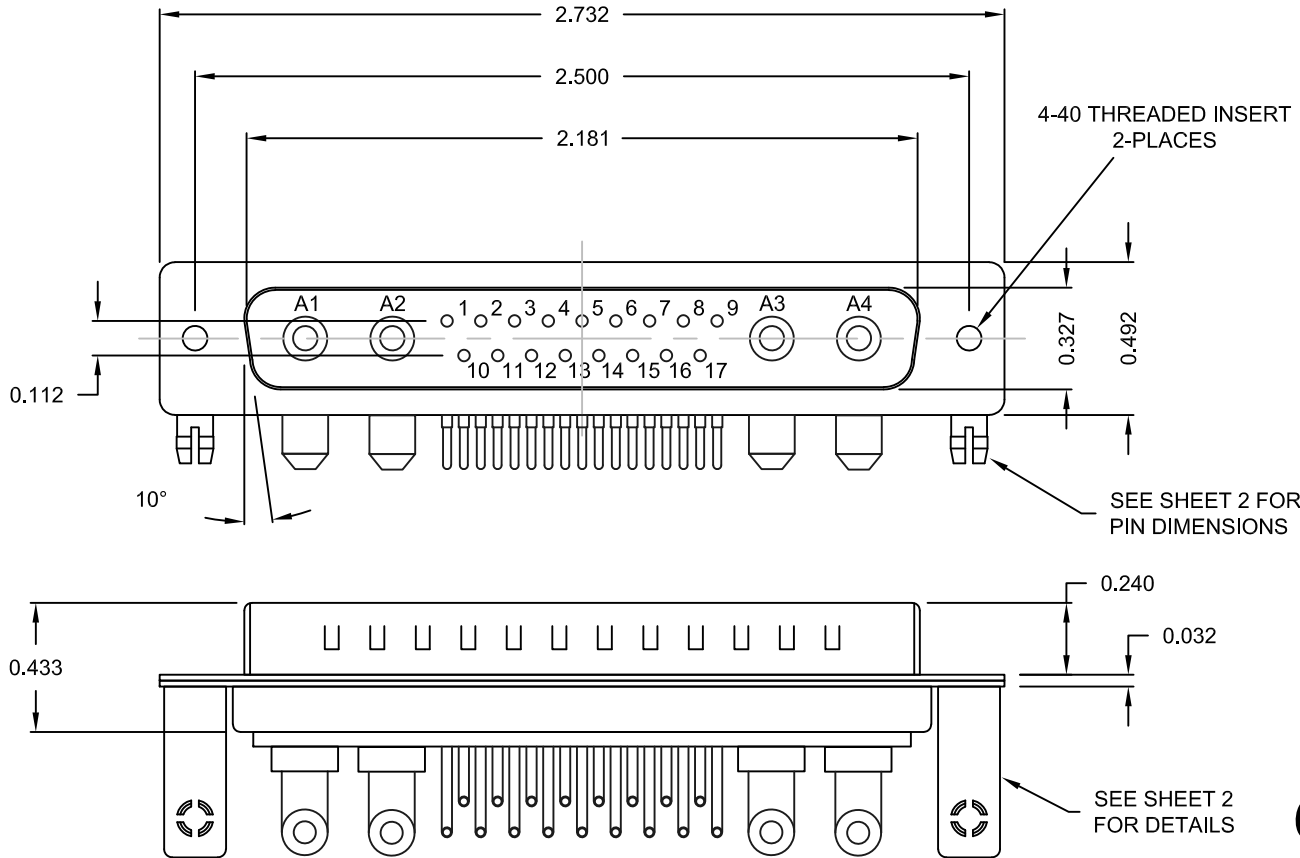

SPECIFICATIONS:

ELECTRICAL:

INSULATOR RESISTANCE: 5 G OHMS Min.
 DIELECTRIC WITHSTANDING: 1,000VAC r.m.s.
 OPERATING TEMPERATURE: -55° C ~ +125° C
 POWER CONTACT RESISTANCE: 1.0 Milliohms Max.
 SIGNAL CONTACT RESISTANCE: 2.7 Milliohms Max.
 POWER PINS: 40 AMPS
 SIGNAL PINS: 5 AMPS

MECHANICAL:

CONTACT INSERTION FORCE: 4.5 Kg Max.
 CONTACT SEPARATOR FORCE: 0.3Kg Min.

MATERIALS:

CONTACTS: COPPER ALLOY
 INSULATOR: PBT THERMOPLASTIC, 30% GLASS FILLED, UL94V-0 RATED, BLACK 230°C PROCESS TEMP.
 SHELL: STEEL
 BOARD LOCK: BRASS, NICKEL PLATED
 CINCHNUT: BRASS, NICKEL PLATED
 BRACKET: STEEL, NICKEL PLATED
 SEAL: F08 FLEXIBLE ADHESIVE

FINISH:

SHELL: NICKEL
 CONTACTS: FULL GOLD FLASH

684S21WA4PL461

46 = 4-40 INSERTS / BOARD LOCKS

RoHS COMPLIANT

MEETS IP67 STANDARDS
 (SEE PAGE 3 FOR SEALING DETAILS)

	THESE DRAWINGS AND SPECIFICATIONS ARE THE PROPERTY OF NorComp AND SHALL NOT BE REPRODUCED, COPIED OR USED AS THE BASIS FOR THE MANUFACTURE OR SALE OF APPARATUS WITHOUT WRITTEN PERMISSION.		DRAWN: M. SIGMON	DATE: 06-12-13
	NorComp		SCALE: NTS	SHEET 1 OF 3
DWG NO. 684S21WA4PL461				

DESCRIPTION: 684 SERIES CONTACTS

NOTE:
POWER CONTACTS COME
PRE-LOADED INTO INSULATORS

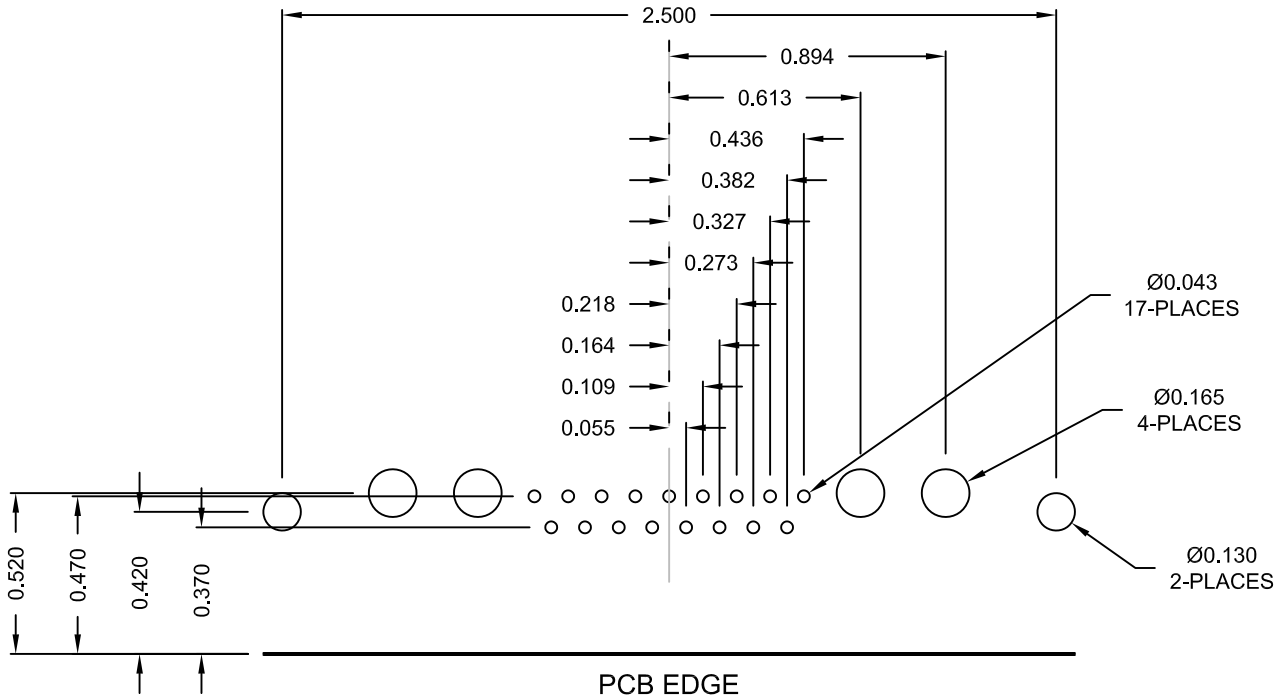

SIGNAL CONTACTS

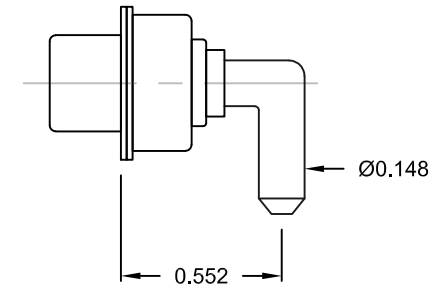

40 AMP POWER CONTACT

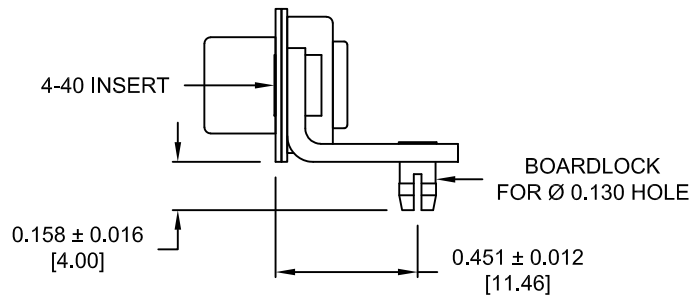

MOUNTING HARDWARE

RoHS COMPLIANT

	THESE DRAWINGS AND SPECIFICATIONS ARE THE PROPERTY OF NorComp AND SHALL NOT BE REPRODUCED, COPIED OR USED AS THE BASIS FOR THE MANUFACTURE OR SALE OF APPARATUS WITHOUT WRITTEN PERMISSION.		DRAWN: M. SIGMON	DATE: 06-12-13
	NorComp		SCALE: NTS	SHEET OF 2 3
DWG NO. 684S21WA4PL461				

DESCRIPTION: 684 SERIES CONTACTS

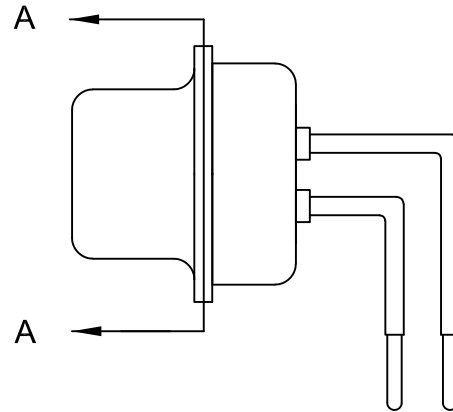

FRONT SEAL APPLIED OVER INSULATOR
AND BETWEEN FRONT & REAR SHELLS

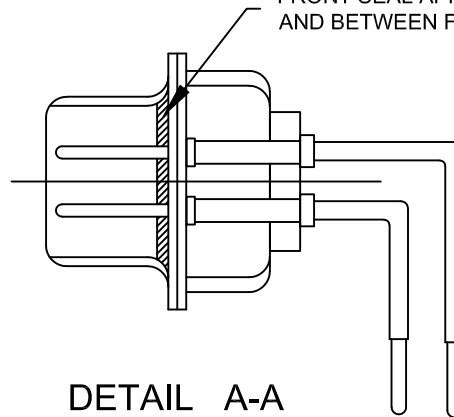

DETAIL A-A

SHOWN FOR REFERENCE ONLY

RoHS COMPLIANT

	THESE DRAWINGS AND SPECIFICATIONS ARE THE PROPERTY OF NorComp AND SHALL NOT BE REPRODUCED, COPIED OR USED AS THE BASIS FOR THE MANUFACTURE OR SALE OF APPARATUS WITHOUT WRITTEN PERMISSION.	DRAWN: M. SIGMON		DATE: 06-12-13	
		SCALE: NTS		SHEET 3 OF 3	
NorComp		DWG NO. 684S21WA4PL461			
		REV 1			