

### FEATURES

#### Low power operation

##### 5 V operation

- 1.0 mA per channel maximum @ 0 Mbps to 2 Mbps
- 3.5 mA per channel maximum @ 10 Mbps
- 31 mA per channel maximum @ 90 Mbps

##### 3 V operation

- 0.7 mA per channel maximum @ 0 Mbps to 2 Mbps
- 2.1 mA per channel maximum @ 10 Mbps
- 20 mA per channel maximum @ 90 Mbps

#### Bidirectional communication

#### 3 V/5 V level translation

#### High temperature operation: 105°C

#### High data rate: dc to 90 Mbps (NRZ)

#### Precise timing characteristics

- 2 ns maximum pulse width distortion
- 2 ns maximum channel-to-channel matching

#### High common-mode transient immunity: >25 kV/μs

#### Output enable function

#### 16-lead SOIC wide body package version (RW-16)

#### 16-lead SOIC wide body enhanced creepage version (RI-16)

#### Safety and regulatory approvals (RI-16 package)

UL recognition: 5000 V rms for 1 minute per UL 1577

CSA Component Acceptance Notice 5A

IEC 60601-1: 250 V rms (reinforced)

IEC 60950-1: 400 V rms (reinforced)

VDE Certificate of Conformity

DIN V VDE V 0884-10 (VDE V 0884-10):2006-12

$V_{ORM} = 846$  V peak

### APPLICATIONS

#### General-purpose, high voltage, multichannel isolation

#### Medical equipment

#### Motor drives

#### Power supplies

### GENERAL DESCRIPTION

The ADuM2400/ADuM2401/ADuM2402<sup>1</sup> are 4-channel digital isolators based on Analog Devices, Inc., iCoupler® technology. Combining high speed CMOS and monolithic air core transformer technology, these isolation components provide outstanding performance characteristics that are superior to alternatives, such as optocoupler devices.

By avoiding the use of LEDs and photodiodes, iCoupler devices remove the design difficulties commonly associated with optocouplers. The typical optocoupler concerns regarding uncertain current transfer ratios, nonlinear transfer functions, and tempera-

<sup>1</sup> Protected by U.S. Patents 5,952,849; 6,873,065; and 7,075,329.

Rev. F **Document Feedback**  
Information furnished by Analog Devices is believed to be accurate and reliable. However, no responsibility is assumed by Analog Devices for its use, nor for any infringements of patents or other rights of third parties that may result from its use. Specifications subject to change without notice. No license is granted by implication or otherwise under any patent or patent rights of Analog Devices. Trademarks and registered trademarks are the property of their respective owners.

### FUNCTIONAL BLOCK DIAGRAMS

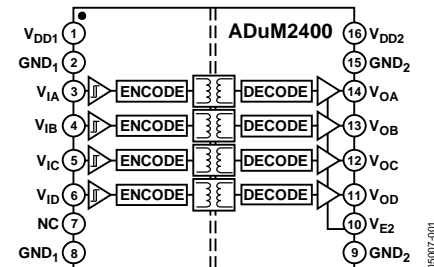

Figure 1. ADuM2400

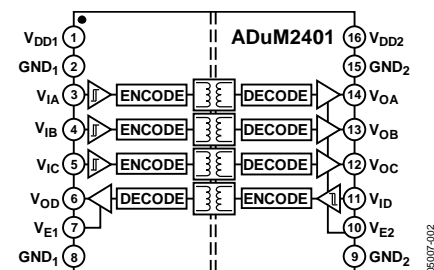

Figure 2. ADuM2401

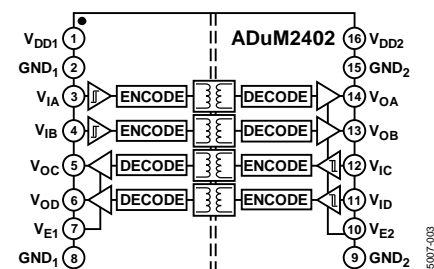

Figure 3. ADuM2402

ture and lifetime effects are eliminated with the simple iCoupler digital interfaces and stable performance characteristics. Furthermore, iCoupler devices run at one-tenth to one-sixth the power of optocouplers at comparable signal data rates.

The ADuM2400/ADuM2401/ADuM2402 isolators provide four independent isolation channels in a variety of channel configurations and data rates (see the Ordering Guide). The ADuM2400/ADuM2401/ADuM2402 models operate with the supply voltage of either side ranging from 2.7 V to 5.5 V, providing compatibility with lower voltage systems as well as enabling a voltage translation functionality across the isolation barrier. In addition, the ADuM2400/ADuM2401/ADuM2402 provide low pulse width distortion (<2 ns for CRWZ grade) and tight channel-to-channel matching (<2 ns for CRWZ grade). The ADuM2400/ADuM2401/ADuM2402 isolators have a patented refresh feature that ensures dc correctness in the absence of input logic transitions and during power-up/power-down conditions.

## TABLE OF CONTENTS

|   |    |  |    |
|---|----|--|----|
| Features .....  | 1  | Recommended Operating Conditions .....             | 11 |
| Applications .....  | 1  | Absolute Maximum Ratings .....                     | 12 |
| General Description .....   | 1  | ESD Caution.....                                   | 12 |
| Functional Block Diagrams .....   | 1  | Pin Configurations and Function Descriptions ..... | 13 |
| Revision History .....  | 2  | Typical Performance Characteristics .....          | 16 |
| Specifications.....   | 3  | Application Information.....                       | 18 |
| Electrical Characteristics—5 V Operation.....                           | 3  | PC Board Layout .....                              | 18 |
| Electrical Characteristics—3 V Operation.....                           | 5  | Propagation Delay-Related Parameters.....          | 18 |
| Electrical Characteristics—Mixed 5 V/3 V or 3 V/5 V<br>Operation.....   | 7  | DC Correctness and Magnetic Field Immunity.....    | 18 |
| Package Characteristics .....   | 10 | Power Consumption .....                            | 19 |
| Regulatory Information.....   | 10 | Insulation Lifetime .....                          | 20 |
| Insulation and Safety-Related Specifications .....                      | 10 | Outline Dimensions .....                           | 21 |
| DIN V VDE V 0884-10 (VDE V 0884-10) Insulation<br>Characteristics ..... | 11 | Ordering Guide .....                               | 22 |

## REVISION HISTORY

### 7/15—Rev. E to Rev. F

|                                     |    |
|-------------------------------------|----|
| Changes to Table 5 and Table 6..... | 10 |
| Updated Outline Dimensions .....    | 21 |
| Changes to Ordering Guide .....     | 22 |

### 2/12—Rev. D to Rev. E

|   |    |
|---|----|
| Created Hyperlink for Safety and Regulatory Approvals<br>Entry in Features Section..... | 1  |
| Change to PC Board Layout Section.....  | 18 |

### 8/11—Rev. C to Rev. D

|   |           |
|---|-----------|
| Added 16-Lead SOIC_IC .....   | Universal |
| Changes to Features Section and General Description<br>Section..... | 1         |
| Changes to Table 5 and Table 6.....                                 | 10        |
| Changes to Table 8 Endnote.....                                     | 11        |
| Updated Outline Dimensions .....                                    | 21        |
| Changes to Ordering Guide .....                                     | 21        |

### 7/08—Rev. B to Rev. C

|                         |    |
|-------------------------|----|
| Changes to Layout ..... | 1  |
| Changes to Table 6..... | 10 |

### 6/07—Rev. A to Rev. B

|   |    |
|---|----|
| Updated VDE Certification Throughout.....         | 1  |
| Changes to Features and Note 1 .....              | 1  |
| Changes to Figure 1, Figure 2, and Figure 3 ..... | 1  |
| Changes to Regulatory Information .....           | 10 |
| Changes to Table 7.....                           | 11 |
| Changes to Insulation Lifetime Section .....      | 20 |
| Updated Outline Dimensions .....                  | 21 |
| Changes to Ordering Guide .....                   | 21 |

### 1/06—Rev. 0 to Rev. A

|   |    |
|---|----|
| Changes to Regulatory Information Section ..... | 13 |
| Updated Outline Dimensions .....                | 23 |
| Changes to Ordering Guide .....                 | 23 |

### 9/05—Revision 0: Initial Version

## SPECIFICATIONS

ELECTRICAL CHARACTERISTICS—5 V OPERATION<sup>1</sup>

4.5 V ≤ V<sub>DD1</sub> ≤ 5.5 V, 4.5 V ≤ V<sub>DD2</sub> ≤ 5.5 V. All minimum/maximum specifications apply over the entire recommended operation range, unless otherwise noted. All typical specifications are at T<sub>A</sub> = 25°C, V<sub>DD1</sub> = V<sub>DD2</sub> = 5 V.

Table 1.

| Parameter   | Symbol   | Min   | Typ   | Max  | Unit | Test Conditions  |
|---|--|---|-------|------|------|--|
| <b>DC SPECIFICATIONS</b>  |  |   |       |      |      |  |
| Input Supply Current per Channel, Quiescent                                 | I <sub>DD1(Q)</sub>  |   | 0.50  | 0.53 | mA   |  |
| Output Supply Current per Channel, Quiescent                                | I <sub>DD0(Q)</sub>  |   | 0.19  | 0.21 | mA   |  |
| <b>ADuM2400</b> Total Supply Current, Four Channels <sup>2</sup>            |  |   |       |      |      |  |
| DC to 2 Mbps  |  |   |       |      |      |  |
| V <sub>DD1</sub> Supply Current   | I <sub>DD1(Q)</sub>  |   | 2.2   | 2.8  | mA   | DC to 1 MHz logic signal frequency   |
| V <sub>DD2</sub> Supply Current   | I <sub>DD2(Q)</sub>  |   | 0.9   | 1.4  | mA   | DC to 1 MHz logic signal frequency   |
| 10 Mbps (BRWZ and CRWZ Grades Only)   |  |   |       |      |      |  |
| V <sub>DD1</sub> Supply Current   | I <sub>DD1(10)</sub>   |   | 8.6   | 10.6 | mA   | 5 MHz logic signal frequency   |
| V <sub>DD2</sub> Supply Current   | I <sub>DD2(10)</sub>   |   | 2.6   | 3.5  | mA   | 5 MHz logic signal frequency   |
| 90 Mbps (CRWZ Grade Only)   |  |   |       |      |      |  |
| V <sub>DD1</sub> Supply Current   | I <sub>DD1(90)</sub>   |   | 70    | 100  | mA   | 45 MHz logic signal frequency  |
| V <sub>DD2</sub> Supply Current   | I <sub>DD2(90)</sub>   |   | 18    | 25   | mA   | 45 MHz logic signal frequency  |
| <b>ADuM2401</b> Total Supply Current, Four Channels <sup>2</sup>            |  |   |       |      |      |  |
| DC to 2 Mbps  |  |   |       |      |      |  |
| V <sub>DD1</sub> Supply Current   | I <sub>DD1(Q)</sub>  |   | 1.8   | 2.4  | mA   | DC to 1 MHz logic signal frequency   |
| V <sub>DD2</sub> Supply Current   | I <sub>DD2(Q)</sub>  |   | 1.2   | 1.8  | mA   | DC to 1 MHz logic signal frequency   |
| 10 Mbps (BRWZ and CRWZ Grades Only)   |  |   |       |      |      |  |
| V <sub>DD1</sub> Supply Current   | I <sub>DD1(10)</sub>   |   | 7.1   | 9.0  | mA   | 5 MHz logic signal frequency   |
| V <sub>DD2</sub> Supply Current   | I <sub>DD2(10)</sub>   |   | 4.1   | 5.0  | mA   | 5 MHz logic signal frequency   |
| 90 Mbps (CRWZ Grade Only)   |  |   |       |      |      |  |
| V <sub>DD1</sub> Supply Current   | I <sub>DD1(90)</sub>   |   | 57    | 82   | mA   | 45 MHz logic signal frequency  |
| V <sub>DD2</sub> Supply Current   | I <sub>DD2(90)</sub>   |   | 31    | 43   | mA   | 45 MHz logic signal frequency  |
| <b>ADuM2402</b> Total Supply Current, Four Channels <sup>2</sup>            |  |   |       |      |      |  |
| DC to 2 Mbps  |  |   |       |      |      |  |
| V <sub>DD1</sub> or V <sub>DD2</sub> Supply Current                         | I <sub>DD1(Q)</sub> , I <sub>DD2(Q)</sub>  |   | 1.5   | 2.1  | mA   | DC to 1 MHz logic signal frequency   |
| 10 Mbps (BRWZ and CRWZ Grades Only)   |  |   |       |      |      |  |
| V <sub>DD1</sub> or V <sub>DD2</sub> Supply Current                         | I <sub>DD1(10)</sub> , I <sub>DD2(10)</sub>  |   | 5.6   | 7.0  | mA   | 5 MHz logic signal frequency   |
| 90 Mbps (CRWZ Grade Only)   |  |   |       |      |      |  |
| V <sub>DD1</sub> or V <sub>DD2</sub> Supply Current                         | I <sub>DD1(90)</sub> , I <sub>DD2(90)</sub>  |   | 44    | 62   | mA   | 45 MHz logic signal frequency  |
| <b>For All Models</b>   |  |   |       |      |      |  |
| Input Currents  | I <sub>IA</sub> , I <sub>IB</sub> , I <sub>IC</sub><br>I <sub>ID</sub> , I <sub>E1</sub> , I <sub>E2</sub> | -10   | +0.01 | +10  | μA   | 0 V ≤ V <sub>IA</sub> , V <sub>IB</sub> , V <sub>IC</sub> , V <sub>ID</sub> ≤ V <sub>DD1</sub> or V <sub>DD2</sub> ,<br>0 V ≤ V <sub>E1</sub> , V <sub>E2</sub> ≤ V <sub>DD1</sub> or V <sub>DD2</sub> |
| Logic High Input Threshold  | V <sub>IHR</sub> , V <sub>EH</sub>   | 2.0   |       |      | V    |  |
| Logic Low Input Threshold   | V <sub>ILR</sub> , V <sub>EL</sub>   |   |       | 0.8  | V    |  |
| Logic High Output Voltages  | V <sub>OAHr</sub> , V <sub>OBHr</sub><br>V <sub>OCHr</sub> , V <sub>ODH</sub>                              | (V <sub>DD1</sub> or V <sub>DD2</sub> ) - 0.1 | 5.0   |      | V    | I <sub>Ox</sub> = -20 μA, V <sub>Ix</sub> = V <sub>IxH</sub>   |
|   |  | (V <sub>DD1</sub> or V <sub>DD2</sub> ) - 0.4 | 4.8   |      | V    | I <sub>Ox</sub> = -4 mA, V <sub>Ix</sub> = V <sub>IxH</sub>  |
| Logic Low Output Voltages   | V <sub>OALr</sub> , V <sub>OBLr</sub><br>V <sub>OCLr</sub> , V <sub>ODL</sub>                              |   | 0.0   | 0.1  | V    | I <sub>Ox</sub> = 20 μA, V <sub>Ix</sub> = V <sub>IxL</sub>  |
|   |  |   | 0.04  | 0.1  | V    | I <sub>Ox</sub> = 400 μA, V <sub>Ix</sub> = V <sub>IxL</sub>   |
|   |  |   | 0.2   | 0.4  | V    | I <sub>Ox</sub> = 4 mA, V <sub>Ix</sub> = V <sub>IxL</sub>   |
| <b>SWITCHING SPECIFICATIONS</b>   |  |   |       |      |      |  |
| <b>ADuM2400ARWZ/ADuM2401ARWZ/ADuM2402ARWZ</b>                               |  |   |       |      |      |  |
| Minimum Pulse Width <sup>3</sup>  | PW   |   |       | 1000 | ns   | C <sub>L</sub> = 15 pF, CMOS signal levels   |
| Maximum Data Rate <sup>4</sup>  |  | 1   |       |      | Mbps | C <sub>L</sub> = 15 pF, CMOS signal levels   |
| Propagation Delay <sup>5</sup>  | t <sub>PHL</sub> , t <sub>PLH</sub>  | 50  | 65    | 100  | ns   | C <sub>L</sub> = 15 pF, CMOS signal levels   |
| Pulse Width Distortion,  t <sub>PLH</sub> - t <sub>PHL</sub>   <sup>5</sup> | PWD  |   | 40    |      | ns   | C <sub>L</sub> = 15 pF, CMOS signal levels   |
| Propagation Delay Skew <sup>6</sup>   | t <sub>PSK</sub>   |   | 50    |      | ns   | C <sub>L</sub> = 15 pF, CMOS signal levels   |
| Channel-to-Channel Matching <sup>7</sup>                                    | t <sub>PSKCD</sub> /t <sub>PSKOD</sub>   |   | 50    |      | ns   | C <sub>L</sub> = 15 pF, CMOS signal levels   |

| Parameter   | Symbol                              | Min | Typ  | Max  | Unit    | Test Conditions  |
|---|-------------------------------------|-----|------|------|---------|--|
| <b>ADuM2400BRWZ/ADuM2401BRWZ/ADuM2402BRWZ</b>                               |                                     |     |      |      |         |  |
| Minimum Pulse Width <sup>3</sup>  | PW                                  |     |      | 100  | ns      | C <sub>L</sub> = 15 pF, CMOS signal levels   |
| Maximum Data Rate <sup>4</sup>  |                                     | 10  |      |      | Mbps    | C <sub>L</sub> = 15 pF, CMOS signal levels   |
| Propagation Delay <sup>5</sup>  | t <sub>PHL</sub> , t <sub>PLH</sub> | 20  | 32   | 50   | ns      | C <sub>L</sub> = 15 pF, CMOS signal levels   |
| Pulse Width Distortion,  t <sub>PLH</sub> - t <sub>PHL</sub>   <sup>5</sup> | PWD                                 |     |      | 3    | ns      | C <sub>L</sub> = 15 pF, CMOS signal levels   |
| Change vs. Temperature  |                                     |     | 5    |      | ps/°C   | C <sub>L</sub> = 15 pF, CMOS signal levels   |
| Propagation Delay Skew <sup>6</sup>   | t <sub>PSK</sub>                    |     |      | 15   | ns      | C <sub>L</sub> = 15 pF, CMOS signal levels   |
| Channel-to-Channel Matching, Codirectional Channels <sup>7</sup>            | t <sub>PSKCD</sub>                  |     |      | 3    | ns      | C <sub>L</sub> = 15 pF, CMOS signal levels   |
| Channel-to-Channel Matching, Opposing-Directional Channels <sup>7</sup>     | t <sub>PSKOD</sub>                  |     |      | 6    | ns      | C <sub>L</sub> = 15 pF, CMOS signal levels   |
| <b>ADuM2400CRWZ/ADuM2401CRWZ/ADuM2402CRWZ</b>                               |                                     |     |      |      |         |  |
| Minimum Pulse Width <sup>3</sup>  | PW                                  |     | 8.3  | 11.1 | ns      | C <sub>L</sub> = 15 pF, CMOS signal levels   |
| Maximum Data Rate <sup>4</sup>  |                                     | 90  | 120  |      | Mbps    | C <sub>L</sub> = 15 pF, CMOS signal levels   |
| Propagation Delay <sup>5</sup>  | t <sub>PHL</sub> , t <sub>PLH</sub> | 18  | 27   | 32   | ns      | C <sub>L</sub> = 15 pF, CMOS signal levels   |
| Pulse Width Distortion,  t <sub>PLH</sub> - t <sub>PHL</sub>   <sup>5</sup> | PWD                                 |     | 0.5  | 2    | ns      | C <sub>L</sub> = 15 pF, CMOS signal levels   |
| Change vs. Temperature  |                                     |     | 3    |      | ps/°C   | C <sub>L</sub> = 15 pF, CMOS signal levels   |
| Propagation Delay Skew <sup>6</sup>   | t <sub>PSK</sub>                    |     |      | 10   | ns      | C <sub>L</sub> = 15 pF, CMOS signal levels   |
| Channel-to-Channel Matching, Codirectional Channels <sup>7</sup>            | t <sub>PSKCD</sub>                  |     |      | 2    | ns      | C <sub>L</sub> = 15 pF, CMOS signal levels   |
| Channel-to-Channel Matching, Opposing-Directional Channels <sup>7</sup>     | t <sub>PSKOD</sub>                  |     |      | 5    | ns      | C <sub>L</sub> = 15 pF, CMOS signal levels   |
| For All Models  |                                     |     |      |      |         |  |
| Output Disable Propagation Delay (High/Low to High Impedance)               | t <sub>PHZ</sub> , t <sub>PLH</sub> |     | 6    | 8    | ns      | C <sub>L</sub> = 15 pF, CMOS signal levels   |
| Output Enable Propagation Delay (High Impedance to High/Low)                | t <sub>PZH</sub> , t <sub>PZL</sub> |     | 6    | 8    | ns      | C <sub>L</sub> = 15 pF, CMOS signal levels   |
| Output Rise/Fall Time (10% to 90%)  | t <sub>R</sub> /t <sub>F</sub>      |     | 2.5  |      | ns      | C <sub>L</sub> = 15 pF, CMOS signal levels   |
| Common-Mode Transient Immunity at Logic High Output <sup>8</sup>            | CM <sub>H</sub>                     | 25  | 35   |      | kV/μs   | V <sub>ix</sub> = V <sub>DD1</sub> or V <sub>DD2</sub> , V <sub>CM</sub> = 1000 V, transient magnitude = 800 V |
| Common-Mode Transient Immunity at Logic Low Output <sup>8</sup>             | CM <sub>L</sub>                     | 25  | 35   |      | kV/μs   | V <sub>ix</sub> = 0 V, V <sub>CM</sub> = 1000 V, transient magnitude = 800 V                                   |
| Refresh Rate  | f <sub>r</sub>                      |     | 1.2  |      | Mbps    |  |
| Input Dynamic Supply Current per Channel <sup>9</sup>                       | I <sub>DD1(D)</sub>                 |     | 0.19 |      | mA/Mbps |  |
| Output Dynamic Supply Current per Channel <sup>9</sup>                      | I <sub>DDO(D)</sub>                 |     | 0.05 |      | mA/Mbps |  |

<sup>1</sup> All voltages are relative to their respective ground.

<sup>2</sup> Supply current values are for all four channels combined running at identical data rates. Output supply current values are specified with no output load present. The supply current associated with an individual channel operating at a given data rate can be calculated as described in the Power Consumption section. See Figure 8 through Figure 10 for information on per channel supply current as a function of data rate for unloaded and loaded conditions. See Figure 11 through Figure 15 for total V<sub>DD1</sub> and V<sub>DD2</sub> supply currents as a function of data rate for ADuM2400/ADuM2401/ADuM2402 channel configurations.

<sup>3</sup> The minimum pulse width is the shortest pulse width at which the specified pulse width distortion is guaranteed.

<sup>4</sup> The maximum data rate is the fastest data rate at which the specified pulse width distortion is guaranteed.

<sup>5</sup> t<sub>PHL</sub> propagation delay is measured from the 50% level of the falling edge of the V<sub>ix</sub> signal to the 50% level of the falling edge of the V<sub>ox</sub> signal. t<sub>PLH</sub> propagation delay is measured from the 50% level of the rising edge of the V<sub>ix</sub> signal to the 50% level of the rising edge of the V<sub>ox</sub> signal.

<sup>6</sup> t<sub>PSK</sub> is the magnitude of the worst-case difference in t<sub>PHL</sub> or t<sub>PLH</sub> that is measured between units at the same operating temperature, supply voltages, and output load within the recommended operating conditions.

<sup>7</sup> Codirectional channel-to-channel matching is the absolute value of the difference in propagation delays between any two channels with inputs on the same side of the isolation barrier. Opposing directional channel-to-channel matching is the absolute value of the difference in propagation delays between any two channels with inputs on opposing sides of the isolation barrier.

<sup>8</sup> CM<sub>H</sub> is the maximum common-mode voltage slew rate that can be sustained while maintaining V<sub>O</sub> > 0.8 V<sub>DD2</sub>. CM<sub>L</sub> is the maximum common-mode voltage slew rate that can be sustained while maintaining V<sub>O</sub> < 0.8 V. The common-mode voltage slew rates apply to both rising and falling common-mode voltage edges. The transient magnitude is the range over which the common mode is slewed.

<sup>9</sup> Dynamic supply current is the incremental amount of supply current required for a 1 Mbps increase in signal data rate. See Figure 8 through Figure 10 for information on per channel supply current for unloaded and loaded conditions. See the Power Consumption section for guidance on calculating per channel supply current for a given data rate.

**ELECTRICAL CHARACTERISTICS—3 V OPERATION<sup>1</sup>**

2.7 V ≤ V<sub>DD1</sub> ≤ 3.6 V, 2.7 V ≤ V<sub>DD2</sub> ≤ 3.6 V. All minimum/maximum specifications apply over the entire recommended operation range, unless otherwise noted. All typical specifications are at T<sub>A</sub> = 25°C, V<sub>DD1</sub> = V<sub>DD2</sub> = 3.0 V.

**Table 2.**

| Parameter   | Symbol   | Min   | Typ   | Max  | Unit | Test Conditions  |
|---|--|---|-------|------|------|--|
| <b>DC SPECIFICATIONS</b>  |  |   |       |      |      |  |
| Input Supply Current per Channel, Quiescent                                 | I <sub>DD1(Q)</sub>  |   | 0.26  | 0.31 | mA   |  |
| Output Supply Current per Channel, Quiescent                                | I <sub>DD0(Q)</sub>  |   | 0.11  | 0.14 | mA   |  |
| <b>ADuM2400</b> Total Supply Current, Four Channels <sup>2</sup>            |  |   |       |      |      |  |
| DC to 2 Mbps  |  |   |       |      |      |  |
| V <sub>DD1</sub> Supply Current   | I <sub>DD1(Q)</sub>  |   | 1.2   | 1.9  | mA   | DC to 1 MHz logic signal frequency   |
| V <sub>DD2</sub> Supply Current   | I <sub>DD2(Q)</sub>  |   | 0.5   | 0.9  | mA   | DC to 1 MHz logic signal frequency   |
| 10 Mbps (BRWZ and CRWZ Grades Only)   |  |   |       |      |      |  |
| V <sub>DD1</sub> Supply Current   | I <sub>DD1(10)</sub>   |   | 4.5   | 6.5  | mA   | 5 MHz logic signal frequency   |
| V <sub>DD2</sub> Supply Current   | I <sub>DD2(10)</sub>   |   | 1.4   | 2.0  | mA   | 5 MHz logic signal frequency   |
| 90 Mbps (CRWZ Grade Only)   |  |   |       |      |      |  |
| V <sub>DD1</sub> Supply Current   | I <sub>DD1(90)</sub>   |   | 37    | 65   | mA   | 45 MHz logic signal frequency  |
| V <sub>DD2</sub> Supply Current   | I <sub>DD2(90)</sub>   |   | 11    | 15   | mA   | 45 MHz logic signal frequency  |
| <b>ADuM2401</b> Total Supply Current, Four Channels <sup>2</sup>            |  |   |       |      |      |  |
| DC to 2 Mbps  |  |   |       |      |      |  |
| V <sub>DD1</sub> Supply Current   | I <sub>DD1(Q)</sub>  |   | 1.0   | 1.6  | mA   | DC to 1 MHz logic signal frequency   |
| V <sub>DD2</sub> Supply Current   | I <sub>DD2(Q)</sub>  |   | 0.7   | 1.2  | mA   | DC to 1 MHz logic signal frequency   |
| 10 Mbps (BRWZ and CRWZ Grades Only)   |  |   |       |      |      |  |
| V <sub>DD1</sub> Supply Current   | I <sub>DD1(10)</sub>   |   | 3.7   | 5.4  | mA   | 5 MHz logic signal frequency   |
| V <sub>DD2</sub> Supply Current   | I <sub>DD2(10)</sub>   |   | 2.2   | 3.0  | mA   | 5 MHz logic signal frequency   |
| 90 Mbps (CRWZ Grade Only)   |  |   |       |      |      |  |
| V <sub>DD1</sub> Supply Current   | I <sub>DD1(90)</sub>   |   | 30    | 52   | mA   | 45 MHz logic signal frequency  |
| V <sub>DD2</sub> Supply Current   | I <sub>DD2(90)</sub>   |   | 18    | 27   | mA   | 45 MHz logic signal frequency  |
| <b>ADuM2402</b> Total Supply Current, Four Channels <sup>2</sup>            |  |   |       |      |      |  |
| DC to 2 Mbps  |  |   |       |      |      |  |
| V <sub>DD1</sub> or V <sub>DD2</sub> Supply Current                         | I <sub>DD1(Q)</sub> , I <sub>DD2(Q)</sub>  |   | 0.9   | 1.5  | mA   | DC to 1 MHz logic signal frequency   |
| 10 Mbps (BRWZ and CRWZ Grades Only)   |  |   |       |      |      |  |
| V <sub>DD1</sub> or V <sub>DD2</sub> Supply Current                         | I <sub>DD1(10)</sub> , I <sub>DD2(10)</sub>  |   | 3.0   | 4.2  | mA   | 5 MHz logic signal frequency   |
| 90 Mbps (CRWZ Grade Only)   |  |   |       |      |      |  |
| V <sub>DD1</sub> or V <sub>DD2</sub> Supply Current                         | I <sub>DD1(90)</sub> , I <sub>DD2(90)</sub>  |   | 24    | 39   | mA   | 45 MHz logic signal frequency  |
| <b>For All Models</b>   |  |   |       |      |      |  |
| Input Currents  | I <sub>IA</sub> , I <sub>IB</sub> , I <sub>IC</sub> ,<br>I <sub>ID</sub> , I <sub>E1</sub> , I <sub>E2</sub> | -10   | +0.01 | +10  | μA   | 0 V ≤ V <sub>IA</sub> , V <sub>IB</sub> , V <sub>IC</sub> , V <sub>ID</sub> ≤ V <sub>DD1</sub> or V <sub>DD2</sub> ,<br>0 V ≤ V <sub>E1</sub> , V <sub>E2</sub> ≤ V <sub>DD1</sub> or V <sub>DD2</sub> |
| Logic High Input Threshold  | V <sub>IH</sub> , V <sub>EH</sub>  | 1.6   |       |      | V    |  |
| Logic Low Input Threshold   | V <sub>IL</sub> , V <sub>EL</sub>  |   |       | 0.4  | V    |  |
| Logic High Output Voltages  | V <sub>OAH</sub> , V <sub>OBH</sub> ,<br>V <sub>OCH</sub> , V <sub>ODH</sub>                                 | (V <sub>DD1</sub> or V <sub>DD2</sub> ) - 0.1 | 3.0   |      | V    | I <sub>Ox</sub> = -20 μA, V <sub>Ix</sub> = V <sub>IxH</sub>   |
|   |  | (V <sub>DD1</sub> or V <sub>DD2</sub> ) - 0.4 | 2.8   |      | V    | I <sub>Ox</sub> = -4 mA, V <sub>Ix</sub> = V <sub>IxH</sub>  |
| Logic Low Output Voltages   | V <sub>OAL</sub> , V <sub>OBL</sub> ,<br>V <sub>OCL</sub> , V <sub>ODL</sub>                                 |   | 0.0   | 0.1  | V    | I <sub>Ox</sub> = 20 μA, V <sub>Ix</sub> = V <sub>IxL</sub>  |
|   |  |   | 0.04  | 0.1  | V    | I <sub>Ox</sub> = 400 μA, V <sub>Ix</sub> = V <sub>IxL</sub>   |
|   |  |   | 0.2   | 0.4  | V    | I <sub>Ox</sub> = 4 mA, V <sub>Ix</sub> = V <sub>IxL</sub>   |
| <b>SWITCHING SPECIFICATIONS</b>   |  |   |       |      |      |  |
| <b>ADuM2400ARWZ/ADuM2401ARWZ/<br/>ADuM2402ARWZ</b>                          |  |   |       |      |      |  |
| Minimum Pulse Width <sup>3</sup>  | PW   |   |       | 1000 | ns   | C <sub>L</sub> = 15 pF, CMOS signal levels   |
| Maximum Data Rate <sup>4</sup>  |  | 1   |       |      | Mbps | C <sub>L</sub> = 15 pF, CMOS signal levels   |
| Propagation Delay <sup>5</sup>  | t <sub>PHL</sub> , t <sub>PLH</sub>  | 50  | 75    | 100  | ns   | C <sub>L</sub> = 15 pF, CMOS signal levels   |
| Pulse Width Distortion,  t <sub>PLH</sub> - t <sub>PHL</sub>   <sup>5</sup> | PWD  |   |       | 40   | ns   | C <sub>L</sub> = 15 pF, CMOS signal levels   |
| Propagation Delay Skew <sup>6</sup>   | t <sub>PSK</sub>   |   |       | 50   | ns   | C <sub>L</sub> = 15 pF, CMOS signal levels   |
| Channel-to-Channel Matching <sup>7</sup>                                    | t <sub>PSKCD</sub> /t <sub>PSKOD</sub>   |   |       | 50   | ns   | C <sub>L</sub> = 15 pF, CMOS signal levels   |

| Parameter   | Symbol             | Min | Typ  | Max  | Unit    | Test Conditions  |
|---|--------------------|-----|------|------|---------|--|
| <b>ADuM2400BRWZ/ADuM2401BRWZ/ADuM2402BRWZ</b>                           |                    |     |      |      |         |  |
| Minimum Pulse Width <sup>3</sup>  | PW                 |     |      | 100  | ns      | $C_L = 15$ pF, CMOS signal levels  |
| Maximum Data Rate <sup>4</sup>  |                    | 10  |      |      | Mbps    | $C_L = 15$ pF, CMOS signal levels  |
| Propagation Delay <sup>5</sup>  | $t_{PHL}, t_{PLH}$ | 20  | 38   | 50   | ns      | $C_L = 15$ pF, CMOS signal levels  |
| Pulse Width Distortion, $ t_{PLH} - t_{PHL} $ <sup>5</sup>              | PWD                |     |      | 3    | ns      | $C_L = 15$ pF, CMOS signal levels  |
| Change vs. Temperature  |                    |     | 5    |      | ps/°C   | $C_L = 15$ pF, CMOS signal levels  |
| Propagation Delay Skew <sup>6</sup>                                     | $t_{PSK}$          |     |      | 22   | ns      | $C_L = 15$ pF, CMOS signal levels  |
| Channel-to-Channel Matching, Codirectional Channels <sup>7</sup>        | $t_{PSKCD}$        |     |      | 3    | ns      | $C_L = 15$ pF, CMOS signal levels  |
| Channel-to-Channel Matching, Opposing-Directional Channels <sup>7</sup> | $t_{PSKOD}$        |     |      | 6    | ns      | $C_L = 15$ pF, CMOS signal levels  |
| <b>ADuM2400CRWZ/ADuM2401CRWZ/ADuM2402CRWZ</b>                           |                    |     |      |      |         |  |
| Minimum Pulse Width <sup>3</sup>  | PW                 |     | 8.3  | 11.1 | ns      | $C_L = 15$ pF, CMOS signal levels  |
| Maximum Data Rate <sup>4</sup>  |                    | 90  | 120  |      | Mbps    | $C_L = 15$ pF, CMOS signal levels  |
| Propagation Delay <sup>5</sup>  | $t_{PHL}, t_{PLH}$ | 20  | 34   | 45   | ns      | $C_L = 15$ pF, CMOS signal levels  |
| Pulse Width Distortion, $ t_{PLH} - t_{PHL} $ <sup>5</sup>              | PWD                |     | 0.5  | 2    | ns      | $C_L = 15$ pF, CMOS signal levels  |
| Change vs. Temperature  |                    |     | 3    |      | ps/°C   | $C_L = 15$ pF, CMOS signal levels  |
| Propagation Delay Skew <sup>6</sup>                                     | $t_{PSK}$          |     |      | 16   | ns      | $C_L = 15$ pF, CMOS signal levels  |
| Channel-to-Channel Matching, Codirectional Channels <sup>7</sup>        | $t_{PSKCD}$        |     |      | 2    | ns      | $C_L = 15$ pF, CMOS signal levels  |
| Channel-to-Channel Matching, Opposing-Directional Channels <sup>7</sup> | $t_{PSKOD}$        |     |      | 5    | ns      | $C_L = 15$ pF, CMOS signal levels  |
| For All Models  |                    |     |      |      |         |  |
| Output Disable Propagation Delay (High/Low to High Impedance)           | $t_{PHZ}, t_{PLH}$ |     | 6    | 8    | ns      | $C_L = 15$ pF, CMOS signal levels  |
| Output Enable Propagation Delay (High Impedance to High/Low)            | $t_{PZH}, t_{PZL}$ |     | 6    | 8    | ns      | $C_L = 15$ pF, CMOS signal levels  |
| Output Rise/Fall Time (10% to 90%)                                      | $t_R/t_F$          |     | 3    |      | ns      | $C_L = 15$ pF, CMOS signal levels  |
| Common-Mode Transient Immunity at Logic High Output <sup>8</sup>        | $ CM_H $           | 25  | 35   |      | kV/μs   | $V_{IX} = V_{DD1}$ or $V_{DD2}$ , $V_{CM} = 1000$ V, transient magnitude = 800 V |
| Common-Mode Transient Immunity at Logic Low Output <sup>8</sup>         | $ CM_L $           | 25  | 35   |      | kV/μs   | $V_{IX} = 0$ V, $V_{CM} = 1000$ V, transient magnitude = 800 V                   |
| Refresh Rate  | $f_r$              |     | 1.1  |      | Mbps    |  |
| Input Dynamic Supply Current per Channel <sup>9</sup>                   | $I_{DD1(D)}$       |     | 0.10 |      | mA/Mbps |  |
| Output Dynamic Supply Current per Channel <sup>9</sup>                  | $I_{DDO(D)}$       |     | 0.03 |      | mA/Mbps |  |

<sup>1</sup> All voltages are relative to their respective ground.

<sup>2</sup> Supply current values are for all four channels combined running at identical data rates. Output supply current values are specified with no output load present. The supply current associated with an individual channel operating at a given data rate can be calculated as described in the Power Consumption section. See Figure 8 through Figure 10 for information on per channel supply current as a function of data rate for unloaded and loaded conditions. See Figure 11 through Figure 15 for total  $V_{DD1}$  and  $V_{DD2}$  supply currents as a function of data rate for ADuM2400/ADuM2401/ADuM2402 channel configurations.

<sup>3</sup> The minimum pulse width is the shortest pulse width at which the specified pulse width distortion is guaranteed.

<sup>4</sup> The maximum data rate is the fastest data rate at which the specified pulse width distortion is guaranteed.

<sup>5</sup>  $t_{PHL}$  propagation delay is measured from the 50% level of the falling edge of the  $V_{IX}$  signal to the 50% level of the falling edge of the  $V_{OX}$  signal.  $t_{PLH}$  propagation delay is measured from the 50% level of the rising edge of the  $V_{IX}$  signal to the 50% level of the rising edge of the  $V_{OX}$  signal.

<sup>6</sup>  $t_{PSK}$  is the magnitude of the worst-case difference in  $t_{PHL}$  or  $t_{PLH}$  that is measured between units at the same operating temperature, supply voltages, and output load within the recommended operating conditions.

<sup>7</sup> Codirectional channel-to-channel matching is the absolute value of the difference in propagation delays between any two channels with inputs on the same side of the isolation barrier. Opposing directional channel-to-channel matching is the absolute value of the difference in propagation delays between any two channels with inputs on opposing sides of the isolation barrier.

<sup>8</sup>  $CM_H$  is the maximum common-mode voltage slew rate that can be sustained while maintaining  $V_O > 0.8 V_{DD2}$ .  $CM_L$  is the maximum common-mode voltage slew rate that can be sustained while maintaining  $V_O < 0.8$  V. The common-mode voltage slew rates apply to both rising and falling common-mode voltage edges. The transient magnitude is the range over which the common mode is slewed.

<sup>9</sup> Dynamic supply current is the incremental amount of supply current required for a 1 Mbps increase in signal data rate. See Figure 8 through Figure 10 for information on per channel supply current for unloaded and loaded conditions. See the Power Consumption section for guidance on calculating per channel supply current for a given data rate.

**ELECTRICAL CHARACTERISTICS—MIXED 5 V/3 V OR 3 V/5 V OPERATION<sup>1</sup>**

5 V/3 V operation:  $4.5\text{ V} \leq V_{DD1} \leq 5.5\text{ V}$ ,  $2.7\text{ V} \leq V_{DD2} \leq 3.6\text{ V}$ . 3 V/5 V operation:  $2.7\text{ V} \leq V_{DD1} \leq 3.6\text{ V}$ ,  $4.5\text{ V} \leq V_{DD2} \leq 5.5\text{ V}$ . All minimum/maximum specifications apply over the entire recommended operation range, unless otherwise noted. All typical specifications are at  $T_A = 25^\circ\text{C}$ ;  $V_{DD1} = 3.0\text{ V}$ ,  $V_{DD2} = 5\text{ V}$ ; or  $V_{DD1} = 5\text{ V}$ ,  $V_{DD2} = 3.0\text{ V}$ .

**Table 3.**

| Parameter   | Symbol        | Min | Typ  | Max  | Unit | Test Conditions                    |
|---|---------------|-----|------|------|------|------------------------------------|
| <b>DC SPECIFICATIONS</b>  |               |     |      |      |      |                                    |
| Input Supply Current per Channel, Quiescent                     | $I_{DD1(Q)}$  |     |      |      |      |                                    |
| 5 V/3 V Operation   |               |     | 0.50 | 0.53 | mA   |                                    |
| 3 V/5 V Operation   |               |     | 0.26 | 0.31 | mA   |                                    |
| Output Supply Current per Channel, Quiescent                    | $I_{DDO(Q)}$  |     |      |      |      |                                    |
| 5 V/3 V Operation   |               |     | 0.11 | 0.14 | mA   |                                    |
| 3 V/5 V Operation   |               |     | 0.19 | 0.21 | mA   |                                    |
| <b>ADuM2400 Total Supply Current, Four Channels<sup>2</sup></b> |               |     |      |      |      |                                    |
| DC to 2 Mbps  |               |     |      |      |      |                                    |
| $V_{DD1}$ Supply Current  | $I_{DD1(Q)}$  |     |      |      |      |                                    |
| 5 V/3 V Operation   |               |     | 2.2  | 2.8  | mA   | DC to 1 MHz logic signal frequency |
| 3 V/5 V Operation   |               |     | 1.2  | 1.9  | mA   | DC to 1 MHz logic signal frequency |
| $V_{DD2}$ Supply Current  | $I_{DD2(Q)}$  |     |      |      |      |                                    |
| 5 V/3 V Operation   |               |     | 0.5  | 0.9  | mA   | DC to 1 MHz logic signal frequency |
| 3 V/5 V Operation   |               |     | 0.9  | 1.4  | mA   | DC to 1 MHz logic signal frequency |
| 10 Mbps (BRWZ and CRWZ Grades Only)                             |               |     |      |      |      |                                    |
| $V_{DD1}$ Supply Current  | $I_{DD1(10)}$ |     |      |      |      |                                    |
| 5 V/3 V Operation   |               |     | 8.6  | 10.6 | mA   | 5 MHz logic signal frequency       |
| 3 V/5 V Operation   |               |     | 4.5  | 6.5  | mA   | 5 MHz logic signal frequency       |
| $V_{DD2}$ Supply Current  | $I_{DD2(10)}$ |     |      |      |      |                                    |
| 5 V/3 V Operation   |               |     | 1.4  | 2.0  | mA   | 5 MHz logic signal frequency       |
| 3 V/5 V Operation   |               |     | 2.6  | 3.5  | mA   | 5 MHz logic signal frequency       |
| 90 Mbps (CRWZ Grade Only)                                       |               |     |      |      |      |                                    |
| $V_{DD1}$ Supply Current  | $I_{DD1(90)}$ |     |      |      |      |                                    |
| 5 V/3 V Operation   |               |     | 70   | 100  | mA   | 45 MHz logic signal frequency      |
| 3 V/5 V Operation   |               |     | 37   | 65   | mA   | 45 MHz logic signal frequency      |
| $V_{DD2}$ Supply Current  | $I_{DD2(90)}$ |     |      |      |      |                                    |
| 5 V/3 V Operation   |               |     | 11   | 15   | mA   | 45 MHz logic signal frequency      |
| 3 V/5 V Operation   |               |     | 18   | 25   | mA   | 45 MHz logic signal frequency      |
| <b>ADuM2401 Total Supply Current, Four Channels<sup>2</sup></b> |               |     |      |      |      |                                    |
| DC to 2 Mbps  |               |     |      |      |      |                                    |
| $V_{DD1}$ Supply Current  | $I_{DD1(Q)}$  |     |      |      |      |                                    |
| 5 V/3 V Operation   |               |     | 1.8  | 2.4  | mA   | DC to 1 MHz logic signal frequency |
| 3 V/5 V Operation   |               |     | 1.0  | 1.6  | mA   | DC to 1 MHz logic signal frequency |
| $V_{DD2}$ Supply Current  | $I_{DD2(Q)}$  |     |      |      |      |                                    |
| 5 V/3 V Operation   |               |     | 0.7  | 1.2  | mA   | DC to 1 MHz logic signal frequency |
| 3 V/5 V Operation   |               |     | 1.2  | 1.8  | mA   | DC to 1 MHz logic signal frequency |
| 10 Mbps (BRWZ and CRWZ Grades Only)                             |               |     |      |      |      |                                    |
| $V_{DD1}$ Supply Current  | $I_{DD1(10)}$ |     |      |      |      |                                    |
| 5 V/3 V Operation   |               |     | 7.1  | 9.0  | mA   | 5 MHz logic signal frequency       |
| 3 V/5 V Operation   |               |     | 3.7  | 5.4  | mA   | 5 MHz logic signal frequency       |
| $V_{DD2}$ Supply Current  | $I_{DD2(10)}$ |     |      |      |      |                                    |
| 5 V/3 V Operation   |               |     | 2.2  | 3.0  | mA   | 5 MHz logic signal frequency       |
| 3 V/5 V Operation   |               |     | 4.1  | 5.0  | mA   | 5 MHz logic signal frequency       |
| 90 Mbps (CRWZ Grade Only)                                       |               |     |      |      |      |                                    |
| $V_{DD1}$ Supply Current  | $I_{DD1(90)}$ |     |      |      |      |                                    |
| 5 V/3 V Operation   |               |     | 57   | 82   | mA   | 45 MHz logic signal frequency      |
| 3 V/5 V Operation   |               |     | 30   | 52   | mA   | 45 MHz logic signal frequency      |

| Parameter   | Symbol   | Min   | Typ   | Max  | Unit | Test Conditions   |
|---|--|---|---|------|------|---|
| V <sub>DD2</sub> Supply Current   | I <sub>DD2 (90)</sub>  |   |   |      |      |   |
| 5 V/3 V Operation   |  |   | 18  | 27   | mA   | 45 MHz logic signal frequency   |
| 3 V/5 V Operation   |  |   | 31  | 43   | mA   | 45 MHz logic signal frequency   |
| <b>ADuM2402</b> Total Supply Current, Four Channels <sup>2</sup>              |  |   |   |      |      |   |
| DC to 2 Mbps  |  |   |   |      |      |   |
| V <sub>DD1</sub> Supply Current   | I <sub>DD1 (Q)</sub>   |   |   |      |      |   |
| 5 V/3 V Operation   |  |   | 1.5   | 2.1  | mA   | DC to 1 MHz logic signal frequency  |
| 3 V/5 V Operation   |  |   | 0.9   | 1.5  | mA   | DC to 1 MHz logic signal frequency  |
| V <sub>DD2</sub> Supply Current   | I <sub>DD2 (Q)</sub>   |   |   |      |      |   |
| 5 V/3 V Operation   |  |   | 0.9   | 1.5  | mA   | DC to 1 MHz logic signal frequency  |
| 3 V/5 V Operation   |  |   | 1.5   | 2.1  | mA   | DC to 1 MHz logic signal frequency  |
| 10 Mbps (BRWZ and CRWZ Grades Only)   |  |   |   |      |      |   |
| V <sub>DD1</sub> Supply Current   | I <sub>DD1 (10)</sub>  |   |   |      |      |   |
| 5 V/3 V Operation   |  |   | 5.6   | 7.0  | mA   | 5 MHz logic signal frequency  |
| 3 V/5 V Operation   |  |   | 3.0   | 4.2  | mA   | 5 MHz logic signal frequency  |
| V <sub>DD2</sub> Supply Current   | I <sub>DD2 (10)</sub>  |   |   |      |      |   |
| 5 V/3 V Operation   |  |   | 3.0   | 4.2  | mA   | 5 MHz logic signal frequency  |
| 3 V/5 V Operation   |  |   | 5.6   | 7.0  | mA   | 5 MHz logic signal frequency  |
| 90 Mbps (CRWZ Grade Only)   |  |   |   |      |      |   |
| V <sub>DD1</sub> Supply Current   | I <sub>DD1 (90)</sub>  |   |   |      |      |   |
| 5 V/3 V Operation   |  |   | 44  | 62   | mA   | 45 MHz logic signal frequency   |
| 3 V/5 V Operation   |  |   | 24  | 39   | mA   | 45 MHz logic signal frequency   |
| V <sub>DD2</sub> Supply Current   | I <sub>DD2 (90)</sub>  |   |   |      |      |   |
| 5 V/3 V Operation   |  |   | 24  | 39   | mA   | 45 MHz logic signal frequency   |
| 3 V/5 V Operation   |  |   | 44  | 62   | mA   | 45 MHz logic signal frequency   |
| For All Models  |  |   |   |      |      |   |
| Input Currents  | I <sub>IAV</sub> , I <sub>IBV</sub> , I <sub>ICV</sub><br>I <sub>IDV</sub> , I <sub>E1V</sub> , I <sub>E2V</sub> | -10   | +0.01   | +10  | μA   | 0 V ≤ V <sub>IAV</sub> , V <sub>IBV</sub> , V <sub>ICV</sub> , V <sub>ID</sub> ≤ V <sub>DD1</sub> or V <sub>DD2</sub> ,<br>0 V ≤ V <sub>E1V</sub> , V <sub>E2V</sub> ≤ V <sub>DD1</sub> or V <sub>DD2</sub> |
| Logic High Input Threshold  | V <sub>IHV</sub> , V <sub>EH</sub>   |   |   |      | V    |   |
| 5 V/3 V Operation   |  | 2.0   |   |      | V    |   |
| 3 V/5 V Operation   |  | 1.6   |   |      | V    |   |
| Logic Low Input Threshold   | V <sub>ILV</sub> , V <sub>EL</sub>   |   |   |      | V    |   |
| 5 V/3 V Operation   |  |   |   | 0.8  | V    |   |
| 3 V/5 V Operation   |  |   |   | 0.4  | V    |   |
| Logic High Output Voltages  | V <sub>OAHV</sub> , V <sub>OAHV</sub><br>V <sub>OCHV</sub> , V <sub>ODH</sub>                                    | (V <sub>DD1</sub> or V <sub>DD2</sub> ) - 0.1 | (V <sub>DD1</sub> or V <sub>DD2</sub> )       |      | V    | I <sub>Ox</sub> = -20 μA, V <sub>Ix</sub> = V <sub>IxH</sub>  |
|   |  | (V <sub>DD1</sub> or V <sub>DD2</sub> ) - 0.4 | (V <sub>DD1</sub> or V <sub>DD2</sub> ) - 0.2 |      | V    | I <sub>Ox</sub> = -4 mA, V <sub>Ix</sub> = V <sub>IxH</sub>   |
| Logic Low Output Voltages   | V <sub>OALV</sub> , V <sub>OBLV</sub><br>V <sub>OCLV</sub> , V <sub>ODL</sub>                                    |   | 0.0   | 0.1  | V    | I <sub>Ox</sub> = 20 μA, V <sub>Ix</sub> = V <sub>IxL</sub>   |
|   |  |   | 0.04  | 0.1  | V    | I <sub>Ox</sub> = 400 μA, V <sub>Ix</sub> = V <sub>IxL</sub>  |
|   |  |   | 0.2   | 0.4  | V    | I <sub>Ox</sub> = 4 mA, V <sub>Ix</sub> = V <sub>IxL</sub>  |
| <b>SWITCHING SPECIFICATIONS</b>   |  |   |   |      |      |   |
| <b>ADuM2400ARWZ/ADuM2401ARWZ/ADuM2402ARWZ</b>                                 |  |   |   |      |      |   |
| Minimum Pulse Width <sup>3</sup>  | PW   |   |   | 1000 | ns   | C <sub>L</sub> = 15 pF, CMOS signal levels  |
| Maximum Data Rate <sup>4</sup>  |  | 1   |   |      | Mbps | C <sub>L</sub> = 15 pF, CMOS signal levels  |
| Propagation Delay <sup>5</sup>  | t <sub>PHLV</sub> , t <sub>PLHV</sub>  | 50  | 70  | 100  | ns   | C <sub>L</sub> = 15 pF, CMOS signal levels  |
| Pulse-Width Distortion,  t <sub>PLHV</sub> - t <sub>PHLV</sub>   <sup>5</sup> | PWD  |   |   | 40   | ns   | C <sub>L</sub> = 15 pF, CMOS signal levels  |
| Propagation Delay Skew <sup>6</sup>   | t <sub>PSK</sub>   |   |   | 50   | ns   | C <sub>L</sub> = 15 pF, CMOS signal levels  |
| Channel-to-Channel Matching <sup>7</sup>                                      | t <sub>PSKCDV</sub> , t <sub>PSKOD</sub>   |   |   | 50   | ns   | C <sub>L</sub> = 15 pF, CMOS signal levels  |
| <b>ADuM2400BRWZ/ADuM2401BRWZ/ADuM2402BRWZ</b>                                 |  |   |   |      |      |   |
| Minimum Pulse Width <sup>3</sup>  | PW   |   |   | 100  | ns   | C <sub>L</sub> = 15 pF, CMOS signal levels  |
| Maximum Data Rate <sup>4</sup>  |  | 10  |   |      | Mbps | C <sub>L</sub> = 15 pF, CMOS signal levels  |
| Propagation Delay <sup>5</sup>  | t <sub>PHLV</sub> , t <sub>PLHV</sub>  | 15  | 35  | 50   | ns   | C <sub>L</sub> = 15 pF, CMOS signal levels  |



| Parameter   | Symbol             | Min | Typ  | Max  | Unit    | Test Conditions  |
|---|--------------------|-----|------|------|---------|--|
| Pulse Width Distortion, $ t_{PLH} - t_{PHL} ^5$                         | PWD                |     | 5    | 3    | ns      | $C_L = 15$ pF, CMOS signal levels  |
| Change vs. Temperature  |                    |     |      |      | ps/°C   | $C_L = 15$ pF, CMOS signal levels  |
| Propagation Delay Skew <sup>6</sup>                                     | $t_{PSK}$          |     |      | 22   | ns      | $C_L = 15$ pF, CMOS signal levels  |
| Channel-to-Channel Matching, Codirectional Channels <sup>7</sup>        | $t_{PSKCD}$        |     |      | 3    | ns      | $C_L = 15$ pF, CMOS signal levels  |
| Channel-to-Channel Matching, Opposing-Directional Channels <sup>7</sup> | $t_{PSKOD}$        |     |      | 6    | ns      | $C_L = 15$ pF, CMOS signal levels  |
| <a href="#">ADuM2400CRWZ/ADuM2401CRWZ/ADuM2402CRWZ</a>                  |                    |     |      |      |         |  |
| Minimum Pulse Width <sup>3</sup>  | PW                 |     | 8.3  | 11.1 | ns      | $C_L = 15$ pF, CMOS signal levels  |
| Maximum Data Rate <sup>4</sup>  |                    | 90  | 120  |      | Mbps    | $C_L = 15$ pF, CMOS signal levels  |
| Propagation Delay <sup>5</sup>  | $t_{PHL}, t_{PLH}$ | 20  | 30   | 40   | ns      | $C_L = 15$ pF, CMOS signal levels  |
| Pulse Width Distortion, $ t_{PLH} - t_{PHL} ^5$                         | PWD                |     | 0.5  | 2    | ns      | $C_L = 15$ pF, CMOS signal levels  |
| Change vs. Temperature  |                    |     | 3    |      | ps/°C   | $C_L = 15$ pF, CMOS signal levels  |
| Propagation Delay Skew <sup>6</sup>                                     | $t_{PSK}$          |     |      | 14   | ns      | $C_L = 15$ pF, CMOS signal levels  |
| Channel-to-Channel Matching, Codirectional Channels <sup>7</sup>        | $t_{PSKCD}$        |     |      | 2    | ns      | $C_L = 15$ pF, CMOS signal levels  |
| Channel-to-Channel Matching, Opposing-Directional Channels <sup>7</sup> | $t_{PSKOD}$        |     |      | 5    | ns      | $C_L = 15$ pF, CMOS signal levels  |
| For All Models  |                    |     |      |      |         |  |
| Output Disable Propagation Delay (High/Low to High Impedance)           | $t_{PHZ}, t_{PLH}$ |     | 6    | 8    | ns      | $C_L = 15$ pF, CMOS signal levels  |
| Output Enable Propagation Delay (High Impedance to High/Low)            | $t_{PZH}, t_{PZL}$ |     | 6    | 8    | ns      | $C_L = 15$ pF, CMOS signal levels  |
| Output Rise/Fall Time (10% to 90%)                                      | $t_R/t_F$          |     |      |      |         | $C_L = 15$ pF, CMOS signal levels  |
| 5 V/3 V Operation   |                    |     | 3.0  |      | ns      |  |
| 3 V/5 V Operation   |                    |     | 2.5  |      | ns      |  |
| Common-Mode Transient Immunity at Logic High Output <sup>8</sup>        | $ CM_H $           | 25  | 35   |      | kV/μs   | $V_{IX} = V_{DD1}$ or $V_{DD2}$ , $V_{CM} = 1000$ V, transient magnitude = 800 V |
| Common-Mode Transient Immunity at Logic Low Output <sup>8</sup>         | $ CM_L $           | 25  | 35   |      | kV/μs   | $V_{IX} = 0$ V, $V_{CM} = 1000$ V, transient magnitude = 800 V                   |
| Refresh Rate  | $f_r$              |     |      |      |         |  |
| 5 V/3 V Operation   |                    |     | 1.2  |      | Mbps    |  |
| 3 V/5 V Operation   |                    |     | 1.1  |      | Mbps    |  |
| Input Dynamic Supply Current per Channel <sup>9</sup>                   | $I_{DDI(D)}$       |     |      |      |         |  |
| 5 V/3 V Operation   |                    |     | 0.19 |      | mA/Mbps |  |
| 3 V/5 V Operation   |                    |     | 0.10 |      | mA/Mbps |  |
| Output Dynamic Supply Current per Channel <sup>9</sup>                  | $I_{DDO(D)}$       |     |      |      |         |  |
| 5 V/3 V Operation   |                    |     | 0.03 |      | mA/Mbps |  |
| 3 V/5 V Operation   |                    |     | 0.05 |      | mA/Mbps |  |

<sup>1</sup> All voltages are relative to their respective ground.

<sup>2</sup> Supply current values are for all four channels combined running at identical data rates. Output supply current values are specified with no output load present. The supply current associated with an individual channel operating at a given data rate can be calculated as described in the Power Consumption section. See Figure 8 through Figure 10 for information on per channel supply current as a function of data rate for unloaded and loaded conditions. See Figure 11 through Figure 15 for total  $V_{DD1}$  and  $V_{DD2}$  supply currents as a function of data rate for [ADuM2400/ADuM2401/ADuM2402](#) channel configurations.

<sup>3</sup> The minimum pulse width is the shortest pulse width at which the specified pulse width distortion is guaranteed.

<sup>4</sup> The maximum data rate is the fastest data rate at which the specified pulse width distortion is guaranteed.

<sup>5</sup>  $t_{PHL}$  propagation delay is measured from the 50% level of the falling edge of the  $V_{IX}$  signal to the 50% level of the falling edge of the  $V_{OX}$  signal.  $t_{PLH}$  propagation delay is measured from the 50% level of the rising edge of the  $V_{IX}$  signal to the 50% level of the rising edge of the  $V_{OX}$  signal.

<sup>6</sup>  $t_{PSK}$  is the magnitude of the worst-case difference in  $t_{PHL}$  or  $t_{PLH}$  that is measured between units at the same operating temperature, supply voltages, and output load within the recommended operating conditions.

<sup>7</sup> Codirectional channel-to-channel matching is the absolute value of the difference in propagation delays between any two channels with inputs on the same side of the isolation barrier. Opposing directional channel-to-channel matching is the absolute value of the difference in propagation delays between any two channels with inputs on opposing sides of the isolation barrier.

<sup>8</sup>  $CM_H$  is the maximum common-mode voltage slew rate that can be sustained while maintaining  $V_O > 0.8 V_{DD2}$ .  $CM_L$  is the maximum common-mode voltage slew rate that can be sustained while maintaining  $V_O < 0.8$  V. The common-mode voltage slew rates apply to both rising and falling common-mode voltage edges. The transient magnitude is the range over which the common mode is slewed.

<sup>9</sup> Dynamic supply current is the incremental amount of supply current required for a 1 Mbps increase in signal data rate. See Figure 8 through Figure 10 for information on per channel supply current for unloaded and loaded conditions. See the Power Consumption section for guidance on calculating per channel supply current for a given data rate.

## PACKAGE CHARACTERISTICS

Table 4.

| Parameter                                      | Symbol           | Min | Typ              | Max | Unit | Test Conditions                                     |
|--|------------------|-----|------------------|-----|------|---|
| Resistance (Input to Output) <sup>1</sup>      | R <sub>I-O</sub> |     | 10 <sup>12</sup> |     | Ω    |   |
| Capacitance (Input to Output) <sup>1</sup>     | C <sub>I-O</sub> |     | 2.2              |     | pF   | f = 1 MHz   |
| Input Capacitance <sup>2</sup>                 | C <sub>I</sub>   |     | 4.0              |     | pF   |   |
| IC Junction-to-Case Thermal Resistance, Side 1 | θ <sub>JCI</sub> |     | 33               |     | °C/W | Thermocouple located at center of package underside |
| IC Junction-to-Case Thermal Resistance, Side 2 | θ <sub>JCO</sub> |     | 28               |     | °C/W |   |

<sup>1</sup> Device considered a 2-terminal device: Pin 1, Pin 2, Pin 3, Pin 4, Pin 5, Pin 6, Pin 7, and Pin 8 shorted together and Pin 9, Pin 10, Pin 11, Pin 12, Pin 13, Pin 14, Pin 15, and Pin 16 shorted together.

<sup>2</sup> Input capacitance is from any input data pin to ground.

## REGULATORY INFORMATION

The ADuM2400/ADuM2401/ADuM2402 are approved by the organizations listed in Table 5. Refer to Table 10 and the Insulation Lifetime section for details regarding recommended maximum working voltages for specific cross-isolation waveforms and insulation levels.

Table 5.

| UL  | CSA   | CQC   | VDE  |
|---|---|---|--|
| Recognized Under UL 1577 Component Recognition Program <sup>1</sup> | Approved under CSA Component Acceptance Notice 5A   | Approved under CQC11-471543-2012  | Certified according to DIN V VDE V 0884-10 (VDE V 0884-10); 2006-12 <sup>2</sup> |
| Single Protection 5000 V rms Isolation Voltage                      | Basic insulation per CSA 60950-1-07 and IEC 60950-1, 600 V rms (848 V peak) maximum working voltage<br><br>RW-16 package: reinforced insulation per CSA 60950-1-07 and IEC 60950-1, 380 V rms (537 V peak) maximum working voltage; reinforced insulation per IEC 60601-1 125 V rms (176 V peak) maximum working voltage<br><br>RI-16 package: reinforced insulation per CSA 60950-1-07 and IEC 60950-1, 400 V rms (565 V peak) maximum working voltage; reinforced insulation per IEC 60601-1 250 V rms (353 V peak) maximum working voltage | Basic insulation per GB4943.1-2011, 600 V rms(848 V peak) maximum working voltage, tropical climate, altitude ≤ 5000 m<br><br>RW-16 package: reinforced insulation per GB4943.1-2011, 380 V rms (537 V peak) maximum working voltage, tropical climate, altitude ≤ 5000 m<br><br>RI-16 package: reinforced insulation per 400 V rms (565 V peak) maximum working voltage, tropical climate, altitude ≤ 5000 m | Reinforced insulation, 846 V peak  |
| File E214100  | File 205078   | File: CQC14001108690  | File 2471900-4880-0001   |

<sup>1</sup> In accordance with UL 1577, each ADuM2400/ADuM2401/ADuM2402 is proof tested by applying an insulation test voltage ≥ 6000 V rms for 1 sec (current leakage detection limit = 10 μA).

<sup>2</sup> In accordance with DIN V VDE V 0884-10, each ADuM2400/ADuM2401/ADuM2402 is proof tested by applying an insulation test voltage ≥ 1590 V peak for 1 sec (partial discharge detection limit = 5 pC). The \* marking branded on the component designates DIN V VDE V 0884-10 approval.

## INSULATION AND SAFETY-RELATED SPECIFICATIONS

Table 6.

| Parameter  | Symbol | Value     | Unit  | Conditions   |
|--|--------|-----------|-------|--|
| Rated Dielectric Insulation Voltage                |        | 5000      | V rms | 1-minute duration  |
| Minimum External Air Gap                           | L(I01) | 8.0 min   | mm    | Distance measured from input terminals to output terminals, shortest distance through air along the PCB mounting plane, as an aid to PC board layout |
| Minimum External Tracking (Creepage) RW-16 Package | L(I02) | 7.7 min   | mm    | Measured from input terminals to output terminals, shortest distance path along body   |
| Minimum External Tracking (Creepage) RI-16 Package | L(I02) | 8.3 min   | mm    | Measured from input terminals to output terminals, shortest distance path along body   |
| Minimum Internal Gap (Internal Clearance)          |        | 0.017 min | mm    | Insulation distance through insulation   |
| Tracking Resistance (Comparative Tracking Index)   | CTI    | >400      | V     | DIN IEC 112/VDE 0303 Part 1  |
| Isolation Group                                    |        | II        |       | Material Group (DIN VDE 0110, 1/89, Table 1)   |

**DIN V VDE V 0884-10 (VDE V 0884-10) INSULATION CHARACTERISTICS**

These isolators are suitable for reinforced electrical isolation only within the safety limit data. Maintenance of the safety data is ensured by means of protective circuits.

Note that the \* marking on packages denotes DIN V VDE V 0884-10 approval for 846 V peak working voltage.

**Table 7.**

| Description   | Conditions   | Symbol     | Characteristic                | Unit   |
|---|--|------------|-------------------------------|--------|
| Installation Classification per DIN VDE 0110<br>For Rated Mains Voltage ≤ 300 V rms<br>For Rated Mains Voltage ≤ 450 V rms<br>For Rated Mains Voltage ≤ 600 V rms |  |            | I to IV<br>I to II<br>I to II |        |
| Climatic Classification   |  |            | 40/105/21                     |        |
| Pollution Degree (DIN VDE 0110, Table 1)  |  |            | 2                             |        |
| Maximum Working Insulation Voltage  |  | $V_{IORM}$ | 846                           | V peak |
| Input-to-Output Test Voltage, Method b1   | $V_{IORM} \times 1.875 = V_{PR}$ , 100% production test, $t_m = 1$ sec, partial discharge < 5 pC | $V_{PR}$   | 1590                          | V peak |
| Input-to-Output Test Voltage, Method a  |  |            |                               |        |
| After Environmental Tests Subgroup 1  | $V_{IORM} \times 1.6 = V_{PR}$ , $t_m = 60$ sec, partial discharge < 5 pC                        | $V_{PR}$   | 1375                          | V peak |
| After Input and/or Safety Test Subgroup 2 and Subgroup 3  | $V_{IORM} \times 1.2 = V_{PR}$ , $t_m = 60$ sec, partial discharge < 5 pC                        |            | 1018                          | V peak |
| Highest Allowable Overvoltage   | Transient overvoltage, $t_{TR} = 10$ seconds   | $V_{TR}$   | 6000                          | V peak |
| Safety-Limiting Values  | Maximum value allowed in the event of a failure; see Figure 4                                    |            |                               |        |
| Case Temperature  |  | $T_S$      | 150                           | °C     |
| Side 1 Current  |  | $I_{S1}$   | 265                           | mA     |
| Side 2 Current  |  | $I_{S2}$   | 335                           | mA     |
| Insulation Resistance at $T_S$  | $V_{IO} = 500$ V   | $R_S$      | >10 <sup>9</sup>              | Ω      |

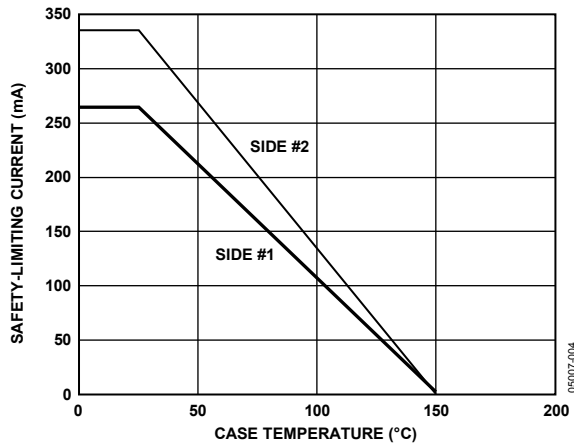

Figure 4. Thermal Derating Curve, Dependence of Safety-Limiting Values with Case Temperature per DIN V VDE V 0884-10

**RECOMMENDED OPERATING CONDITIONS**

**Table 8.**

| Parameter  | Rating          |
|--|-----------------|
| Operating Temperature ( $T_A$ )                        | -40°C to +105°C |
| Supply Voltages <sup>1</sup> ( $V_{DD1}$ , $V_{DD2}$ ) | 2.7 V to 5.5 V  |
| Input Signal Rise and Fall Times                       | 1.0 ms          |

<sup>1</sup> All voltages are relative to their respective ground.

## ABSOLUTE MAXIMUM RATINGS

Table 9.

| Parameter  | Rating                      |
|--|-----------------------------|
| Storage Temperature Range ( $T_{ST}$ )   | -65°C to +150°C             |
| Ambient Operating Temperature Range ( $T_A$ )  | -40°C to +105°C             |
| Supply Voltage Range ( $V_{DD1}$ , $V_{DD2}$ ) <sup>1</sup>  | -0.5 V to +7.0 V            |
| Input Voltage Range ( $V_{IA}$ , $V_{IB}$ , $V_{IC}$ , $V_{ID}$ , $V_{E1}$ , $V_{E2}$ ) <sup>1,2</sup> | -0.5 V to $V_{DD1} + 0.5$ V |
| Output Voltage Range ( $V_{OA}$ , $V_{OB}$ , $V_{OC}$ , $V_{OD}$ ) <sup>1,2</sup>                      | -0.5 V to $V_{DD0} + 0.5$ V |
| Average Output Current Per Pin <sup>3</sup>  |                             |
| Side 1 ( $I_{O1}$ )  | -18 mA to +18 mA            |
| Side 2 ( $I_{O2}$ )  | -22 mA to +22 mA            |
| Common-Mode Transients <sup>4</sup>  | -100 kV/μs to +100 kV/μs    |

<sup>1</sup> All voltages are relative to their respective ground.

<sup>2</sup>  $V_{DD1}$  and  $V_{DD0}$  refer to the supply voltages on the input and output sides of a given channel, respectively. See the PC Board Layout section.

<sup>3</sup> See Figure 4 for maximum rated current values for various temperatures.

<sup>4</sup> Refers to common-mode transients across the insulation barrier. Common-mode transients exceeding the Absolute Maximum Rating can cause latch-up or permanent damage.

Stresses at or above those listed under Absolute Maximum Ratings may cause permanent damage to the product. This is a stress rating only; functional operation of the product at these or any other conditions above those indicated in the operational section of this specification is not implied. Operation beyond the maximum operating conditions for extended periods may affect product reliability.

### ESD CAUTION



**ESD (electrostatic discharge) sensitive device.** Charged devices and circuit boards can discharge without detection. Although this product features patented or proprietary protection circuitry, damage may occur on devices subjected to high energy ESD. Therefore, proper ESD precautions should be taken to avoid performance degradation or loss of functionality.

Table 10. Maximum Continuous Working Voltage<sup>1</sup>

| Parameter  | Max | Unit   | Constraint   |
|--|-----|--------|--|
| AC Voltage, Bipolar Waveform                           | 565 | V peak | 50-year minimum lifetime   |
| AC Voltage, Unipolar Waveform<br>Reinforced Insulation | 846 | V peak | Maximum approved working voltage per IEC 60950-1 and VDE V 0884-10 |
| DC Voltage<br>Reinforced Insulation                    | 846 | V peak | Maximum approved working voltage per IEC 60950-1 and VDE V 0884-10 |

<sup>1</sup> Refers to continuous voltage magnitude imposed across the isolation barrier. See the Insulation Lifetime section for more details.

Table 11. Truth Table (Positive Logic)

| $V_{Ix}$ Input <sup>1</sup> | $V_{Ex}$ Input | $V_{DD1}$ State <sup>1</sup> | $V_{DD0}$ State <sup>1</sup> | $V_{Ox}$ Output <sup>1</sup> | Notes  |
|-----------------------------|----------------|------------------------------|------------------------------|------------------------------|--|
| H                           | H or NC        | Powered                      | Powered                      | H                            |  |
| L                           | H or NC        | Powered                      | Powered                      | L                            |  |
| X                           | L              | Powered                      | Powered                      | Z                            |  |
| X                           | H or NC        | Unpowered                    | Powered                      | H                            | Outputs return to input state within 1 μs of $V_{DD1}$ power restoration.  |
| X                           | L              | Unpowered                    | Powered                      | Z                            |  |
| X                           | X              | Powered                      | Unpowered                    | Indeterminate                | Outputs return to input state within 1 μs of $V_{DD0}$ power restoration if $V_{Ex}$ state is H or NC. Outputs return to high impedance state within 8 ns of $V_{DD0}$ power restoration if $V_{Ex}$ state is L. |

<sup>1</sup>  $V_{Ix}$  and  $V_{Ox}$  refer to the input and output signals of a given channel (A, B, C, or D).  $V_{Ex}$  refers to the output enable signal on the same side as the  $V_{Ox}$  outputs.  $V_{DD1}$  and  $V_{DD0}$  refer to the supply voltages on the input and output sides of the given channel, respectively.

## PIN CONFIGURATIONS AND FUNCTION DESCRIPTIONS

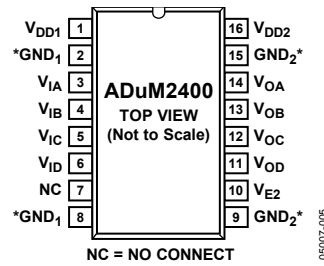

\*PIN 2 AND PIN 8 ARE INTERNALLY CONNECTED, AND CONNECTING BOTH TO GND<sub>1</sub> IS RECOMMENDED. PIN 9 AND PIN 15 ARE INTERNALLY CONNECTED, AND CONNECTING BOTH TO GND<sub>2</sub> IS RECOMMENDED.

Figure 5. ADuM2400 Pin Configuration

Table 12. ADuM2400 Pin Function Descriptions

| Pin No. | Mnemonic         | Description  |
|---------|------------------|--|
| 1       | V <sub>DD1</sub> | Supply Voltage for Isolator Side 1, 2.7 V to 5.5 V.  |
| 2       | GND <sub>1</sub> | Ground 1. Ground reference for Isolator Side 1.  |
| 3       | V <sub>IA</sub>  | Logic Input A.   |
| 4       | V <sub>IB</sub>  | Logic Input B.   |
| 5       | V <sub>IC</sub>  | Logic Input C.   |
| 6       | V <sub>ID</sub>  | Logic Input D.   |
| 7       | NC               | No Connect.  |
| 8       | GND <sub>1</sub> | Ground 1. Ground reference for Isolator Side 1.  |
| 9       | GND <sub>2</sub> | Ground 2. Ground reference for Isolator Side 2.  |
| 10      | V <sub>E2</sub>  | Output Enable 2. Active high logic input. V <sub>OAV</sub> , V <sub>OVB</sub> , V <sub>OVC</sub> , and V <sub>OD</sub> outputs are enabled when V <sub>E2</sub> is high or disconnected. V <sub>OAV</sub> , V <sub>OVB</sub> , V <sub>OVC</sub> , and V <sub>OD</sub> outputs are disabled when V <sub>E2</sub> is low. In noisy environments, connecting V <sub>E2</sub> to an external logic high or low is recommended. |
| 11      | V <sub>OD</sub>  | Logic Output D.  |
| 12      | V <sub>OC</sub>  | Logic Output C.  |
| 13      | V <sub>OB</sub>  | Logic Output B.  |
| 14      | V <sub>OA</sub>  | Logic Output A.  |
| 15      | GND <sub>2</sub> | Ground 2. Ground reference for Isolator Side 2.  |
| 16      | V <sub>DD2</sub> | Supply Voltage for Isolator Side 2, 2.7 V to 5.5 V.  |

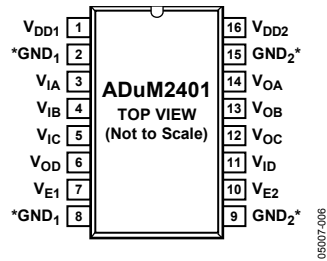

\*PIN 2 AND PIN 8 ARE INTERNALLY CONNECTED, AND CONNECTING BOTH TO GND<sub>1</sub> IS RECOMMENDED. PIN 9 AND PIN 15 ARE INTERNALLY CONNECTED, AND CONNECTING BOTH TO GND<sub>2</sub> IS RECOMMENDED.

Figure 6. ADuM2401 Pin Configuration

Table 13. ADuM2401 Pin Function Descriptions

| Pin No. | Mnemonic         | Description  |
|---------|------------------|--|
| 1       | V <sub>DD1</sub> | Supply Voltage for Isolator Side 1, 2.7 V to 5.5 V.  |
| 2       | GND <sub>1</sub> | Ground 1. Ground reference for Isolator Side 1.  |
| 3       | V <sub>IA</sub>  | Logic Input A.   |
| 4       | V <sub>IB</sub>  | Logic Input B.   |
| 5       | V <sub>IC</sub>  | Logic Input C.   |
| 6       | V <sub>OD</sub>  | Logic Output D.  |
| 7       | V <sub>E1</sub>  | Output Enable 1. Active high logic input. V <sub>OD</sub> output is enabled when V <sub>E1</sub> is high or disconnected. V <sub>OD</sub> is disabled when V <sub>E1</sub> is low. In noisy environments, connecting V <sub>E1</sub> to an external logic high or low is recommended.  |
| 8       | GND <sub>1</sub> | Ground 1. Ground reference for Isolator Side 1.  |
| 9       | GND <sub>2</sub> | Ground 2. Ground reference for Isolator Side 2.  |
| 10      | V <sub>E2</sub>  | Output Enable 2. Active high logic input. V <sub>OA</sub> , V <sub>OB</sub> , and V <sub>OC</sub> outputs are enabled when V <sub>E2</sub> is high or disconnected. V <sub>OA</sub> , V <sub>OB</sub> , and V <sub>OC</sub> outputs are disabled when V <sub>E2</sub> is low. In noisy environments, connecting V <sub>E2</sub> to an external logic high or low is recommended. |
| 11      | V <sub>ID</sub>  | Logic Input D.   |
| 12      | V <sub>OC</sub>  | Logic Output C.  |
| 13      | V <sub>OB</sub>  | Logic Output B.  |
| 14      | V <sub>OA</sub>  | Logic Output A.  |
| 15      | GND <sub>2</sub> | Ground 2. Ground reference for Isolator Side 2.  |
| 16      | V <sub>DD2</sub> | Supply Voltage for Isolator Side 2, 2.7 V to 5.5 V.  |

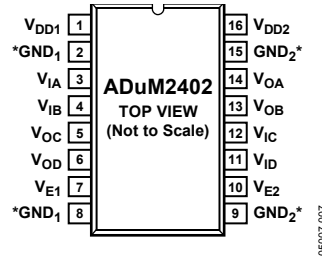

\*PIN 2 AND PIN 8 ARE INTERNALLY CONNECTED, AND CONNECTING BOTH TO GND<sub>1</sub> IS RECOMMENDED. PIN 9 AND PIN 15 ARE INTERNALLY CONNECTED, AND CONNECTING BOTH TO GND<sub>2</sub> IS RECOMMENDED.

Figure 7. ADuM2402 Pin Configuration

Table 14. ADuM2402 Pin Function Descriptions

| Pin No. | Mnemonic         | Description  |
|---------|------------------|--|
| 1       | V <sub>DD1</sub> | Supply Voltage for Isolator Side 1, 2.7 V to 5.5 V.  |
| 2       | GND <sub>1</sub> | Ground 1. Ground reference for Isolator Side 1.  |
| 3       | V <sub>IA</sub>  | Logic Input A.   |
| 4       | V <sub>IB</sub>  | Logic Input B.   |
| 5       | V <sub>OC</sub>  | Logic Output C.  |
| 6       | V <sub>OD</sub>  | Logic Output D.  |
| 7       | V <sub>E1</sub>  | Output Enable 1. Active high logic input. V <sub>OC</sub> and V <sub>OD</sub> outputs are enabled when V <sub>E1</sub> is high or disconnected. V <sub>OC</sub> and V <sub>OD</sub> outputs are disabled when V <sub>E1</sub> is low. In noisy environments, connecting V <sub>E1</sub> to an external logic high or low is recommended. |
| 8       | GND <sub>1</sub> | Ground 1. Ground reference for Isolator Side 1.  |
| 9       | GND <sub>2</sub> | Ground 2. Ground reference for Isolator Side 2.  |
| 10      | V <sub>E2</sub>  | Output Enable 2. Active high logic input. V <sub>OA</sub> and V <sub>OB</sub> outputs are enabled when V <sub>E2</sub> is high or disconnected. V <sub>OA</sub> and V <sub>OB</sub> outputs are disabled when V <sub>E2</sub> is low. In noisy environments, connecting V <sub>E2</sub> to an external logic high or low is recommended. |
| 11      | V <sub>ID</sub>  | Logic Input D.   |
| 12      | V <sub>IC</sub>  | Logic Input C.   |
| 13      | V <sub>OB</sub>  | Logic Output B.  |
| 14      | V <sub>OA</sub>  | Logic Output A.  |
| 15      | GND <sub>2</sub> | Ground 2. Ground reference for Isolator Side 2.  |
| 16      | V <sub>DD2</sub> | Supply Voltage for Isolator Side 2, 2.7 V to 5.5 V.  |

TYPICAL PERFORMANCE CHARACTERISTICS

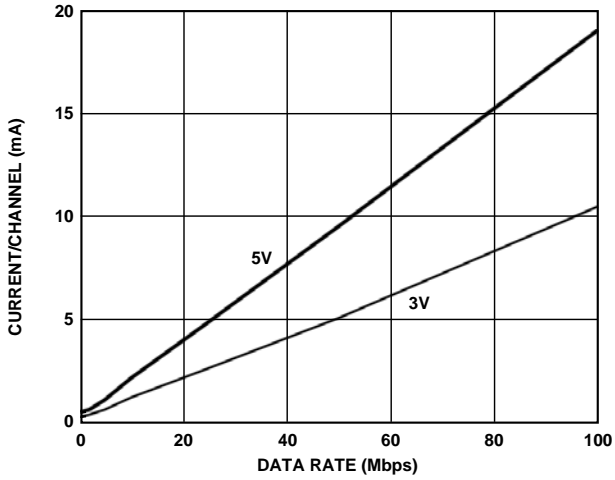

Figure 8. Typical Input Supply Current per Channel vs. Data Rate for 5 V and 3 V Operation (No Output Load)

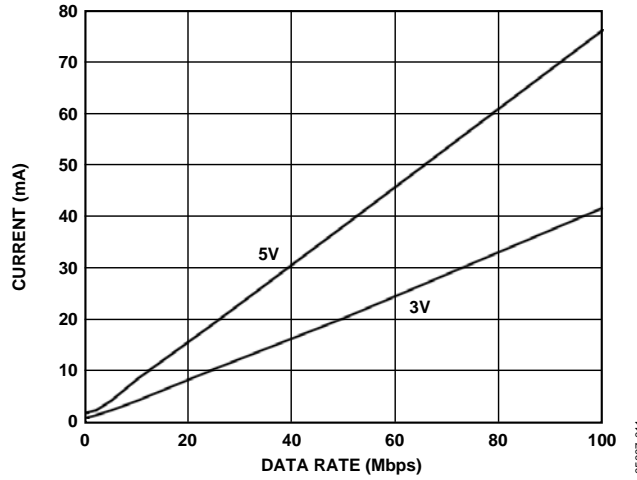

Figure 11. Typical ADuM2400  $V_{DD1}$  Supply Current vs. Data Rate for 5 V and 3 V Operation

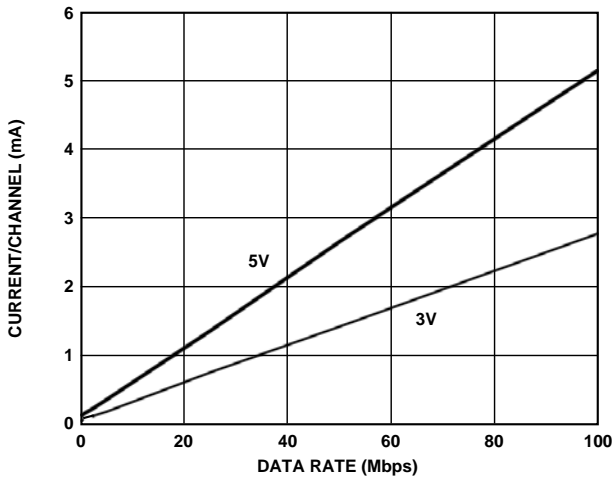

Figure 9. Typical Output Supply Current per Channel vs. Data Rate for 5 V and 3 V Operation (No Output Load)

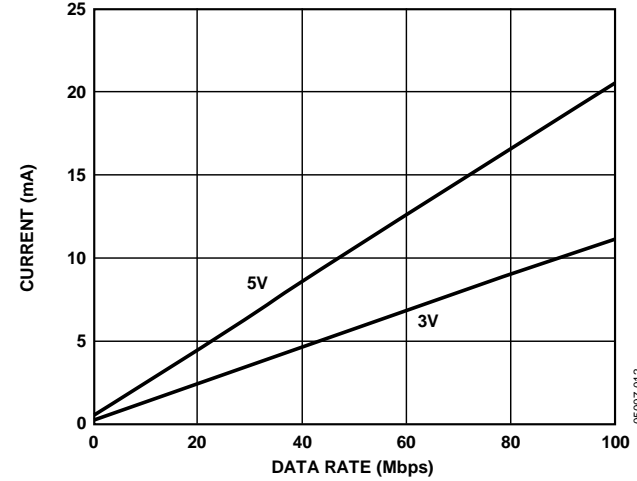

Figure 12. Typical ADuM2400  $V_{DD2}$  Supply Current vs. Data Rate for 5 V and 3 V Operation

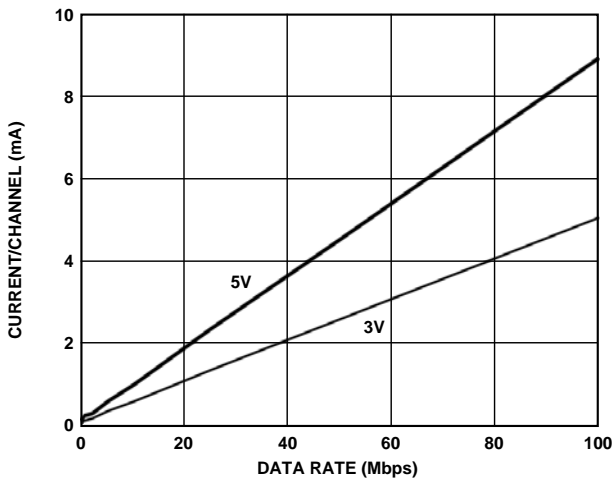

Figure 10. Typical Output Supply Current per Channel vs. Data Rate for 5 V and 3 V Operation (15 pF Output Load)

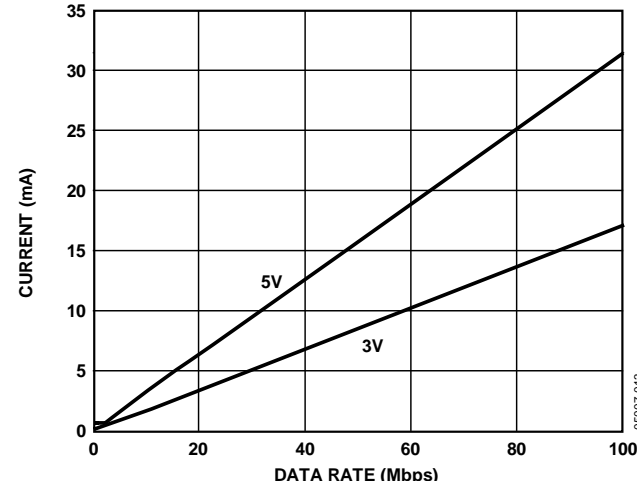

Figure 13. Typical ADuM2401  $V_{DD1}$  Supply Current vs. Data Rate for 5 V and 3 V Operation



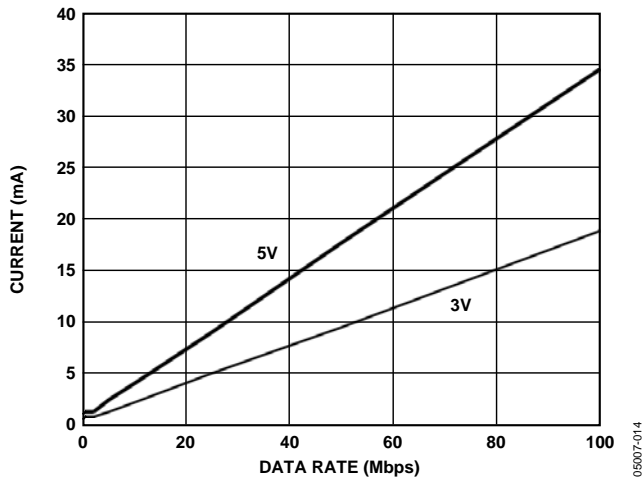

Figure 14. Typical ADuM2401  $V_{DD2}$  Supply Current vs. Data Rate for 5 V and 3 V Operation

05007-014

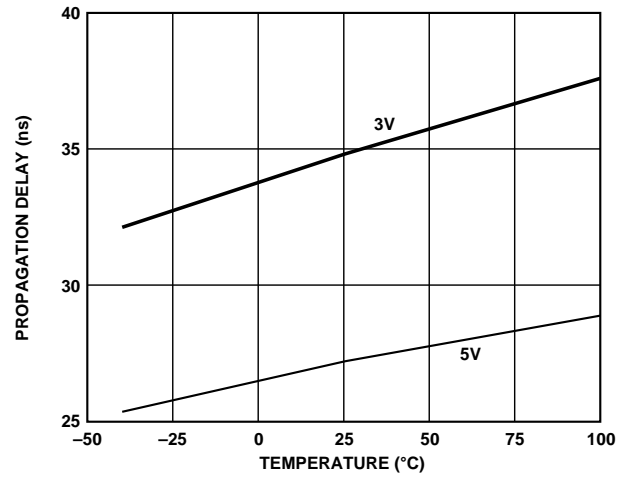

Figure 16. Propagation Delay vs. Temperature, C Grade

05007-016

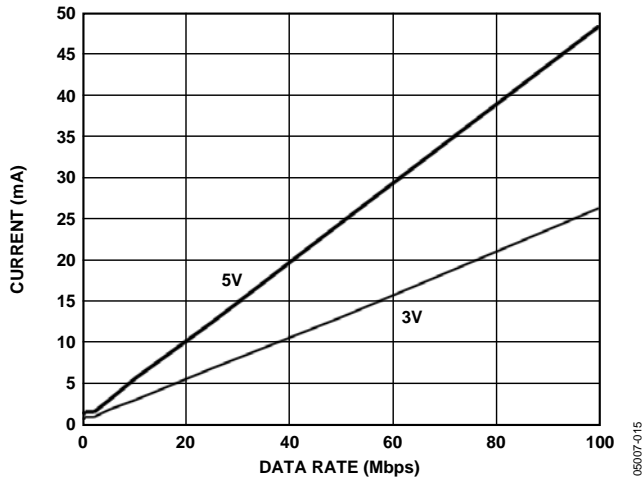

Figure 15. Typical ADuM2402  $V_{DD1}$  or  $V_{DD2}$  Supply Current vs. Data Rate for 5 V and 3 V Operation

05007-015

## APPLICATION INFORMATION

### PC BOARD LAYOUT

The ADuM2400/ADuM2401/ADuM2402 digital isolator requires no external interface circuitry for the logic interfaces. Power supply bypassing is strongly recommended at the input and output supply pins (see Figure 17). Bypass capacitors are most conveniently connected between Pin 1 and Pin 2 for V<sub>DD1</sub> and between Pin 15 and Pin 16 for V<sub>DD2</sub>. The capacitor value should be between 0.01 μF and 0.1 μF. The total lead length between both ends of the capacitor and the input power supply pin should not exceed 20 mm. Bypassing between Pin 1 and Pin 8 and between Pin 9 and Pin 16 should be considered unless the ground pair on each package side are connected close to the package.

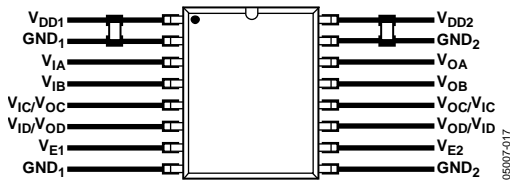

Figure 17. Recommended Printed Circuit Board Layout

In applications involving high common-mode transients, ensure that board coupling across the isolation barrier is minimized. Furthermore, the board layout should be designed such that any coupling that does occur equally affects all pins on a given component side. Failure to ensure this could cause voltage differentials between pins exceeding the device's Absolute Maximum Ratings, thereby leading to latch-up or permanent damage.

See the AN-1109 Application Note for board layout guidelines.

### PROPAGATION DELAY-RELATED PARAMETERS

Propagation delay is a parameter that describes the length of time it takes for a logic signal to propagate through a component. The propagation delay to a logic low output can differ from the propagation delay to logic high.

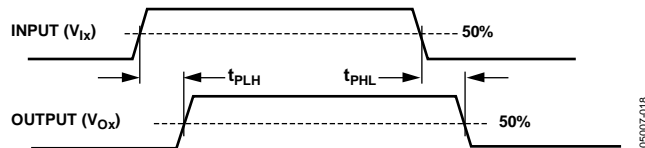

Figure 18. Propagation Delay Parameters

Pulse width distortion is the maximum difference between these two propagation delay values and is an indication of how accurately the input signal's timing is preserved.

Channel-to-channel matching refers to the maximum amount the propagation delay differs among channels within a single ADuM2400/ADuM2401/ADuM2402 component.

Propagation delay skew refers to the maximum amount the propagation delay differs among multiple ADuM2400/ADuM2401/ADuM2402 components operated under the same conditions.

### DC CORRECTNESS AND MAGNETIC FIELD IMMUNITY

Positive and negative logic transitions at the isolator input cause narrow (~1 ns) pulses to be sent via the transformer to the decoder. The decoder is bistable and is therefore either set or reset by the pulses, indicating input logic transitions. In the absence of logic transitions at the input for more than ~1 μs, a periodic set of refresh pulses indicative of the correct input state are sent to ensure dc correctness at the output. If the decoder receives no internal pulses for more than approximately 5 μs, the input side is assumed to be without power or nonfunctional; in which case, the isolator output is forced to a default state (see Table 11) by the watchdog timer circuit.

The limitation on the ADuM2400/ADuM2401/ADuM2402 magnetic field immunity is set by the condition in which induced voltage in the transformer's receiving coil is large enough to either falsely set or reset the decoder. The following analysis defines the conditions under which this can occur. The 3 V operating condition of the ADuM2400/ADuM2401/ADuM2402 is examined because it represents the most susceptible mode of operation.

The pulses at the transformer output have an amplitude greater than 1.0 V. The decoder has a sensing threshold at about 0.5 V, therefore establishing a 0.5 V margin in which induced voltages can be tolerated. The voltage induced across the receiving coil is given by

$$V = (-d\beta/dt)\sum r_n^2; n = 1, 2, \dots, N$$

where:

$\beta$  is the magnetic flux density (gauss).

$N$  is the number of turns in the receiving coil.

$r_n$  is the radius of the  $n^{\text{th}}$  turn in the receiving coil (cm).

Given the geometry of the receiving coil in the ADuM2400/ADuM2401/ADuM2402 and an imposed requirement that the induced voltage be at most 50% of the 0.5 V margin at the decoder, a maximum allowable magnetic field is calculated as shown in Figure 19.

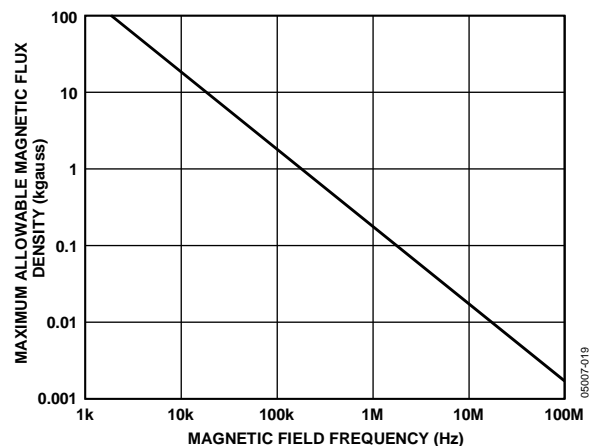

Figure 19. Maximum Allowable External Magnetic Flux Density

For example, at a magnetic field frequency of 1 MHz, the maximum allowable magnetic field of 0.2 kgauss induces a voltage of 0.25 V at the receiving coil. This is about 50% of the sensing threshold and does not cause a faulty output transition. Similarly, if such an event were to occur during a transmitted pulse (and was of the worst-case polarity), it would reduce the received pulse from >1.0 V to 0.75 V—still well above the 0.5 V sensing threshold of the decoder.

The preceding magnetic flux density values correspond to specific current magnitudes at given distances away from the ADuM2400/ADuM2401/ADuM2402 transformers. Figure 20 expresses these allowable current magnitudes as a function of frequency for selected distances. As can be seen, the ADuM2400/ADuM2401/ADuM2402 is immune and can be affected only by extremely large currents operated at high frequency and very close to the component. For the 1 MHz example noted, place a 0.5 kA current 5 mm away from the ADuM2400/ADuM2401/ADuM2402 to affect the component's operation.

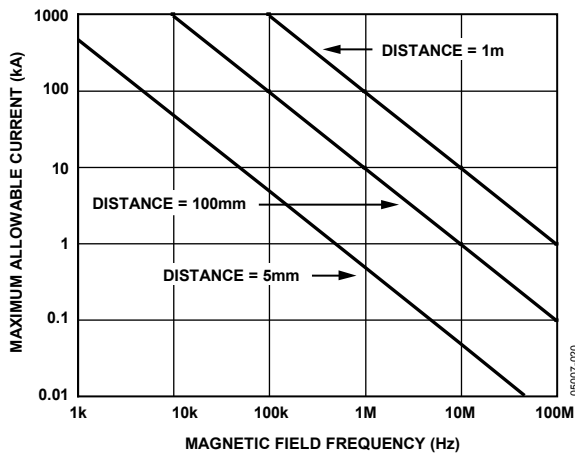

Figure 20. Maximum Allowable Current for Various Current-to-ADuM2400/ADuM2401/ADuM2402 Spacings

Note that at combinations of strong magnetic field and high frequency, any loops formed by printed circuit board traces could induce sufficiently large error voltages to trigger the thresholds of succeeding circuitry. Care should be taken in the layout of such traces to avoid this possibility.

**POWER CONSUMPTION**

The supply current at a given channel of the ADuM2400/ADuM2401/ADuM2402 isolator is a function of the supply voltage, the data rate of the channel, and the output load of the channel.

For each input channel, the supply current is given by:

$$I_{DDI} = I_{DDI(Q)} \quad f \leq 0.5f_r$$

$$I_{DDI} = I_{DDI(D)} \times (2f - f_r) + I_{DDI(Q)} \quad f > 0.5f_r$$

For each output channel, the supply current is given by:

$$I_{DDO} = I_{DDO(Q)} \quad f \leq 0.5f_r$$

$$I_{DDO} = (I_{DDO(D)} + (0.5 \times 10^{-3} \times C_L V_{DDO}) \times (2f - f_r)) + I_{DDO(Q)} \quad f > 0.5f_r$$

where:

$I_{DDI(D)}$ ,  $I_{DDO(D)}$  are the input and output dynamic supply currents per channel (mA/Mbps).

$C_L$  is the output load capacitance (pF).

$V_{DDO}$  is the output supply voltage (V).

$f$  is the input logic signal frequency (MHz, half of the input data rate, NRZ signaling).

$f_r$  is the input stage refresh rate (Mbps).

$I_{DDI(Q)}$ ,  $I_{DDO(Q)}$  are the specified input and output quiescent supply currents (mA).

To calculate the total  $I_{DD1}$  and  $I_{DD2}$ , the supply currents for each input and output channel corresponding to  $I_{DD1}$  and  $I_{DD2}$  are calculated and totaled. Figure 8 and Figure 9 provide per channel supply currents as a function of data rate for an unloaded output condition. Figure 10 provides per channel supply current as a function of data rate for a 15 pF output condition. Figure 11 through Figure 15 provide the total  $I_{DD1}$  and  $I_{DD2}$  as a function of data rate for the ADuM2400/ADuM2401/ADuM2402 channel configurations.

## INSULATION LIFETIME

All insulation structures eventually break down when subjected to voltage stress over a sufficiently long period. The rate of insulation degradation is dependent on the characteristics of the voltage waveform applied across the insulation. In addition to the testing performed by the regulatory agencies, Analog Devices carries out an extensive set of evaluations to determine the lifetime of the insulation structure within the [ADuM2400/ADuM2401/ADuM2402](#).

Analog Devices performs accelerated life testing using voltage levels higher than the rated continuous working voltage. Acceleration factors for several operating conditions are determined. These factors allow calculation of the time to failure at the actual working voltage. The values shown in Table 10 summarize the peak voltage for 50 years of service life for a bipolar ac operating condition and the maximum CSA/VDE approved working voltages. In many cases, the approved working voltage is higher than the 50-year service life voltage. Operation at these high working voltages can lead to shortened insulation life in some cases.

The insulation lifetime of the [ADuM2400/ADuM2401/ADuM2402](#) depends on the voltage waveform type imposed across the isolation barrier. The *iCoupler* insulation structure degrades at different rates, depending on whether the waveform is bipolar ac, unipolar ac, or dc. Figure 21, Figure 22, and Figure 23 illustrate these different isolation voltage waveforms.

Bipolar ac voltage is the most stringent environment. The goal of a 50-year operating lifetime under the ac bipolar condition determines Analog Devices recommended maximum working voltage.

In the case of unipolar ac or dc voltage, the stress on the insulation is significantly lower. This allows operation at higher working voltages while still achieving a 50-year service life. The working voltages listed in Table 10 can be applied while maintaining the 50-year minimum lifetime, provided the voltage conforms to either the unipolar ac or dc voltage cases. Any cross-insulation voltage waveform that does not conform to Figure 22 or Figure 23 should be treated as a bipolar ac waveform and its peak voltage should be limited to the 50-year lifetime voltage value listed in Table 10.

Note that the voltage presented in Figure 22 is shown as sinusoidal for illustration purposes only. It is meant to represent any voltage waveform varying between 0 V and some limiting value. The limiting value can be positive or negative, but the voltage cannot cross 0 V.

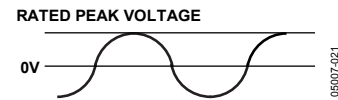

Figure 21. Bipolar AC Waveform

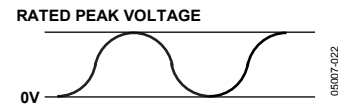

Figure 22. Unipolar AC Waveform

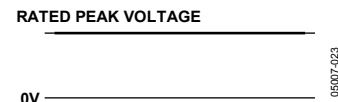
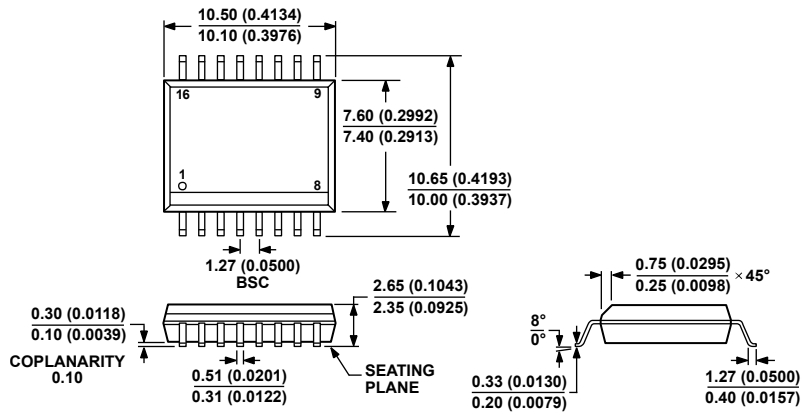

Figure 23. DC Waveform

OUTLINE DIMENSIONS



COMPLIANT TO JEDEC STANDARDS MS-013-AA  
 CONTROLLING DIMENSIONS ARE IN MILLIMETERS; INCH DIMENSIONS  
 (IN PARENTHESES) ARE ROUNDED-OFF MILLIMETER EQUIVALENTS FOR  
 REFERENCE ONLY AND ARE NOT APPROPRIATE FOR USE IN DESIGN.

03-27-2007-B

Figure 24. 16-Lead Standard Small Outline Package [SOIC\_W]  
 Wide Body (RW-16)  
 Dimensions shown in millimeters and (inches)

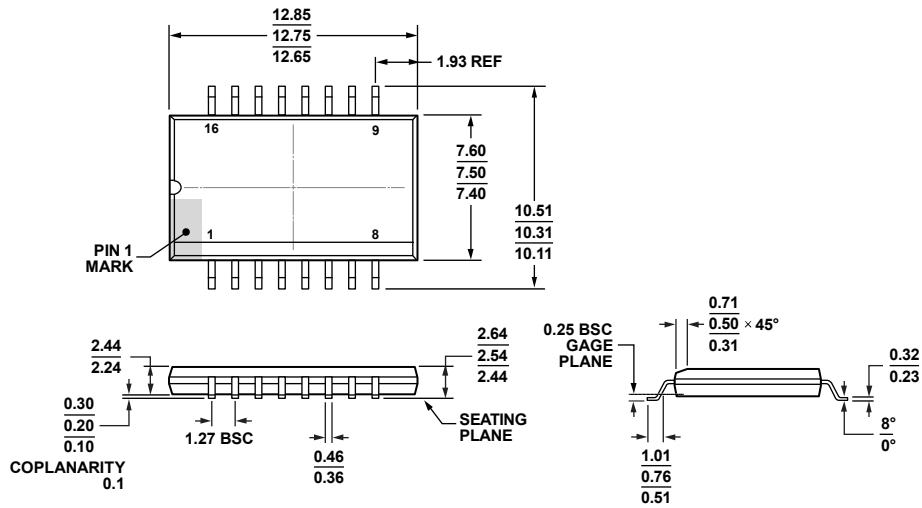

COMPLIANT TO JEDEC STANDARDS MS-013-AC

Figure 25. 16-Lead Standard Small Outline Package, with Increased Creepage [SOIC\_IC]  
 Wide Body  
 (RI-16-2)  
 Dimensions shown in millimeters

11-15-2011-A

## ORDERING GUIDE

| Model <sup>1,2</sup> | Number of Inputs, V <sub>DD1</sub> Side | Number of Inputs, V <sub>DD2</sub> Side | Maximum Data Rate (Mbps) | Maximum Propagation Delay, 5 V (ns) | Maximum Pulse Width Distortion (ns) | Temperature Range | Package Description | Package Option |
|----------------------|---|---|--------------------------|-------------------------------------|-------------------------------------|-------------------|---------------------|----------------|
| ADuM2400ARWZ         | 4                                       | 0                                       | 1                        | 100                                 | 40                                  | –40°C to +105°C   | 16-Lead SOIC_W      | RW-16          |
| ADuM2400BRWZ         | 4                                       | 0                                       | 10                       | 50                                  | 3                                   | –40°C to +105°C   | 16-Lead SOIC_W      | RW-16          |
| ADuM2400CRWZ         | 4                                       | 0                                       | 90                       | 32                                  | 2                                   | –40°C to +105°C   | 16-Lead SOIC_W      | RW-16          |
| ADuM2400ARIZ         | 4                                       | 0                                       | 1                        | 100                                 | 40                                  | –40°C to +105°C   | 16-Lead SOIC_IC     | RI-16-2        |
| ADuM2400BRIZ         | 4                                       | 0                                       | 10                       | 50                                  | 3                                   | –40°C to +105°C   | 16-Lead SOIC_IC     | RI-16-2        |
| ADuM2400CRIZ         | 4                                       | 0                                       | 90                       | 32                                  | 2                                   | –40°C to +105°C   | 16-Lead SOIC_IC     | RI-16-2        |
| ADuM2401ARWZ         | 3                                       | 1                                       | 1                        | 100                                 | 40                                  | –40°C to +105°C   | 16-Lead SOIC_W      | RW-16          |
| ADuM2401BRWZ         | 3                                       | 1                                       | 10                       | 50                                  | 3                                   | –40°C to +105°C   | 16-Lead SOIC_W      | RW-16          |
| ADuM2401CRWZ         | 3                                       | 1                                       | 90                       | 32                                  | 2                                   | –40°C to +105°C   | 16-Lead SOIC_W      | RW-16          |
| ADuM2401ARIZ         | 3                                       | 1                                       | 1                        | 100                                 | 40                                  | –40°C to +105°C   | 16-Lead SOIC_IC     | RI-16-2        |
| ADuM2401BRIZ         | 3                                       | 1                                       | 10                       | 50                                  | 3                                   | –40°C to +105°C   | 16-Lead SOIC_IC     | RI-16-2        |
| ADuM2401CRIZ         | 3                                       | 1                                       | 90                       | 32                                  | 2                                   | –40°C to +105°C   | 16-Lead SOIC_IC     | RI-16-2        |
| ADuM2402ARWZ         | 2                                       | 2                                       | 1                        | 100                                 | 40                                  | –40°C to +105°C   | 16-Lead SOIC_W      | RW-16          |
| ADuM2402BRWZ         | 2                                       | 2                                       | 10                       | 50                                  | 3                                   | –40°C to +105°C   | 16-Lead SOIC_W      | RW-16          |
| ADuM2402CRWZ         | 2                                       | 2                                       | 90                       | 32                                  | 2                                   | –40°C to +105°C   | 16-Lead SOIC_W      | RW-16          |
| ADuM2402ARIZ         | 2                                       | 2                                       | 1                        | 100                                 | 40                                  | –40°C to +105°C   | 16-Lead SOIC_IC     | RI-16-2        |
| ADuM2402BRIZ         | 2                                       | 2                                       | 10                       | 50                                  | 3                                   | –40°C to +105°C   | 16-Lead SOIC_IC     | RI-16-2        |
| ADuM2402CRIZ         | 2                                       | 2                                       | 90                       | 32                                  | 2                                   | –40°C to +105°C   | 16-Lead SOIC_IC     | RI-16-2        |

<sup>1</sup> Tape and reel is available. The addition of an -RL suffix designates a 13" (1,000 units) tape and reel option.

<sup>2</sup> Z = RoHS Compliant Part.

**NOTES**

NOTES



# Mouser Electronics

Authorized Distributor

Click to View Pricing, Inventory, Delivery & Lifecycle Information:

## [Analog Devices Inc.:](#)

[ADUM2401BRIZ-RL](#) [ADUM2400CRWZ](#) [ADUM2402ARWZ-RL](#) [ADUM2400BRWZ-RL](#) [ADUM2402BRWZ](#)  
[ADUM2401CRIZ](#) [ADUM2402CRIZ-RL](#) [ADUM2400CRWZ-RL](#) [ADUM2400ARIZ-RL](#) [ADUM2401CRWZ-RL](#)  
[ADUM2402ARIZ-RL](#) [ADUM2400ARWZ](#) [ADUM2401ARWZ-RL](#) [ADUM2401CRWZ](#) [ADUM2400CRIZ-RL](#)  
[ADUM2402BRIZ-RL](#) [ADUM2400ARWZ-RL](#) [ADUM2401ARIZ-RL](#) [ADUM2400ARIZ](#) [ADUM2400CRIZ](#) [ADUM2400BRIZ-](#)  
[RL](#) [ADUM2401BRIZ](#) [ADUM2402ARWZ](#) [ADUM2400BRWZ](#) [ADUM2401CRIZ-RL](#) [ADUM2402ARIZ](#) [ADUM2400BRIZ](#)  
[ADUM2402CRWZ](#) [ADUM2401ARWZ](#) [ADUM2402CRWZ-RL](#) [ADUM2401BRWZ](#) [ADUM2402BRWZ-RL](#)  
[ADUM2401ARIZ](#) [ADUM2402BRIZ](#) [ADUM2402CRIZ](#) [ADUM2401BRWZ-RL](#)