

## LOW DROPOUT VOLTAGE REGULATOR

### ■ GENERAL DESCRIPTION

The NJM2830 is a 300mA output low dropout voltage regulator with ON/OFF control.

Advanced Bipolar technology achieves low noise, high ripple rejection and low quiescent current.

2.1V to 15.5V output voltage range, 1 $\mu$ F small decoupling capacitor, built-in noise bypass capacitor make the NJM2830 suitable for various applications.

### ■ PACKAGE OUTLINE

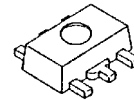

NJM2830U1

### ■ FEATURES

- Output voltage options available      2.1 ~ 15.5V (0.1V step)
- High Ripple Rejection                    75dB typ. (f=1kHz Vo=3V Version)
- Output Noise Voltage                    Vno=50 $\mu$ Vrms typ. (Vo=3V Version)
- Output capacitor with 1.0 $\mu$ F ceramic capacitor (Vo $\geq$ 5.1V)
- Output Current                            Io(max.)=300mA
- High Precision Output                    Vo $\pm$ 1.0%
- Low Dropout Voltage                    0.10V typ. (Io=100mA)
- ON/OFF Control                            (Active High)
- Internal Thermal Overload Protection
- Internal Over Current Protection
- Bipolar Technology
- Package Outline                            SOT-89-5

### ■ PIN CONFIGURATION

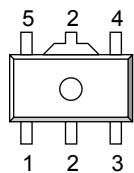

NJM2830U1

1. CONTROL
2. GND
3. NC
4. V<sub>OUT</sub>
5. V<sub>IN</sub>

### ■ EQUIVALENT CIRCUIT

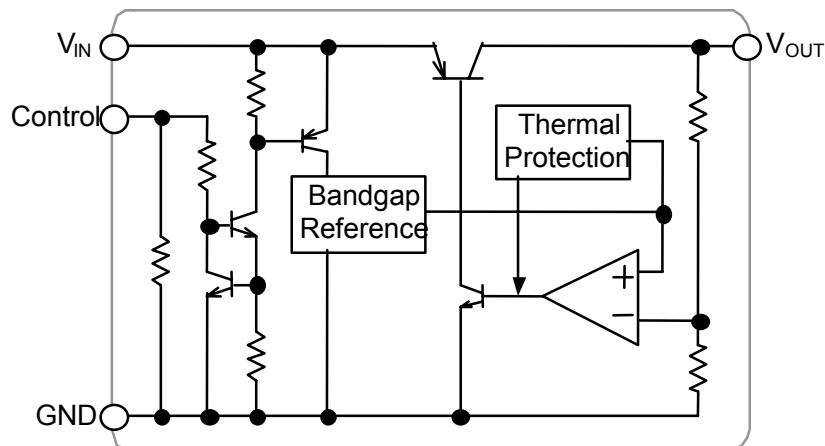

# NJM2830

---

## ■ OUTPUT VOLTAGE

Device Name	Vout
NJM2830U1-21	2.1V
NJM2830U1-25	2.5V
NJM2830U1-03	3.0V
NJM2830U1-33	3.3V
NJM2830U1-05	5.0V
NJM2830U1-57	5.7V
NJM2830U1-58	5.8V
NJM2830U1-06	6.0V
NJM2830U1-08	8.0V
NJM2830U1-85	8.5V
NJM2830U1-86	8.6V
NJM2830U1-09	9.0V
NJM2830U1-12	12.0V
NJM2830U1-15	15.0V

The WHITE column shows applicable Voltage Rank(s)

## ■ ABSOLUTE MAXIMUM RATINGS (Ta=25°C)

PARAMETER	SYMBOL	RATINGS	UNIT
Input Voltage	$V_{IN}$	+20	V
Control Voltage	$V_{CONT}$	+20	V
Power Dissipation	$P_D$	440	mW
Operating Temperature	$T_{opr}$	-40~+85	°C
Storage Temperature	$T_{stg}$	-40~+150	°C

## ■ INPUT VOLTAGE RANGE

$V_{IN}=+2.3V\sim 18V$  (In case of  $V_o < 2.2V$ )

## ■ ELECTRICAL CHARACTERISTICS

( $V_{IN}=V_o+1V$ ,  $C_{IN}=0.1\mu F$ ,  $C_o=1.0\mu F$  (4.9V< $V_o\leq 5.5V$ : $C_o=2.2\mu F$ , 2.9V< $V_o\leq 4.9V$ : $C_o=4.7\mu F$ ,  $V_o\leq 2.9V$ :  $C_o=10\mu F$ ),  $T_a=25^\circ C$ )

PARAMETER	SYMBOL	TEST CONDITION	MIN.	TYP.	MAX.	UNIT	
Output Voltage	$V_o$	$I_o=30mA$	-1.0%	—	+1.0%	V	
Quiescent Current	$I_Q$	$I_o=0mA$ , except $I_{cont}$	$V_o\leq 5V$ Version	—	130	180	$\mu A$
			5V< $V_o\leq 10V$ Version	—	145	195	$\mu A$
			10V< $V_o\leq 15V$ Version	—	160	210	$\mu A$
Quiescent Current at Control OFF	$I_{Q(OFF)}$	$V_{CONT}=0V$	—	—	100	nA	
Output Current	$I_o$	$V_o-0.3V$	300	400	—	mA	
Line Regulation	$\Delta V_o/\Delta V_{IN}$	$V_{IN}=V_o+1V \sim V_o+6V$ ( $V_o\leq 12V$ Version) $V_{IN}=V_o+1V \sim 18V$ ( $V_o>12V$ Version), $I_o=30mA$	—	—	0.10	%/V	
Load Regulation	$\Delta V_o/\Delta I_o$	$I_o=0 \sim 300mA$	—	—	0.009	%/mA	
Dropout Voltage(*1)	$\Delta V_{I-O}$	$I_o=100mA$	—	0.10	0.18	V	
Ripple Rejection	RR	$e_{in}=200mV_{rms}$ , $f=1kHz$ , $I_o=10mA$ , $V_o=3V$ Version	—	75	—	dB	
Average Temperature Coefficient of Output Voltage	$\Delta V_o/\Delta T_a$	$T_a=0 \sim 85^\circ C$ , $I_o=10mA$	—	$\pm 50$	—	ppm/°C	
Output Noise Voltage	$V_{NO}$	$f=10Hz \sim 80kHz$ , $I_o=10mA$ $V_o=3V$ Version	—	50	—	$\mu V_{rms}$	
Control Current	$I_{CONT}$	$V_{CONT}=1.6V$	—	3	12	$\mu A$	
Control Voltage for ON-state	$V_{CONT(ON)}$		1.6	—	—	V	
Control Voltage for OFF-state	$V_{CONT(OFF)}$		—	—	0.6	V	

(\*1): The above specification is a common specification for all output voltages.

Therefore, it may be different from the individual specification for a specific output voltage.

# NJM2830

## TEST CIRCUIT

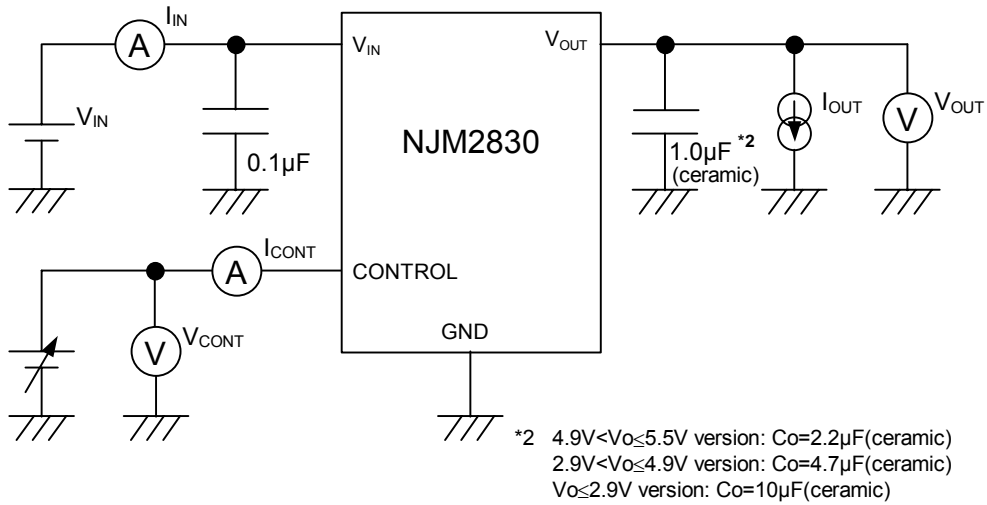

## TYPICAL APPLICATIONS

① In the case where ON/OFF Control is not required:

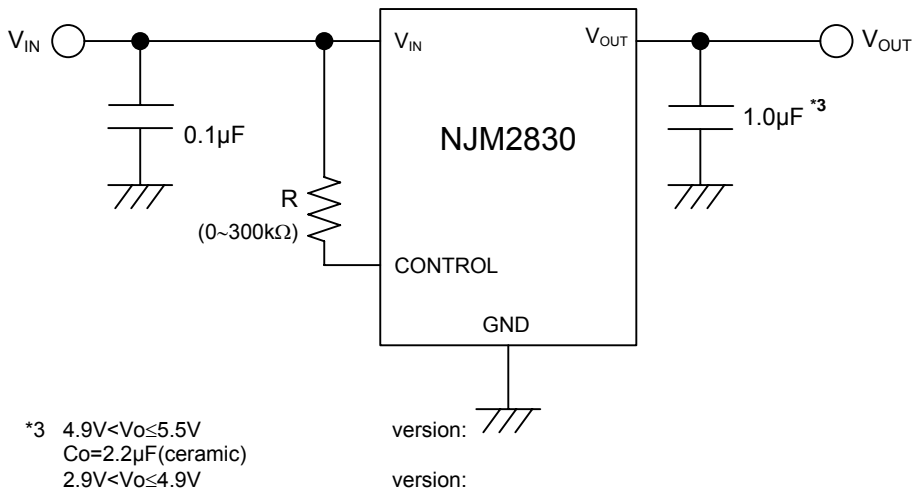

Connect control terminal to  $V_{IN}$  terminal

## ② In use of ON/OFF CONTROL:

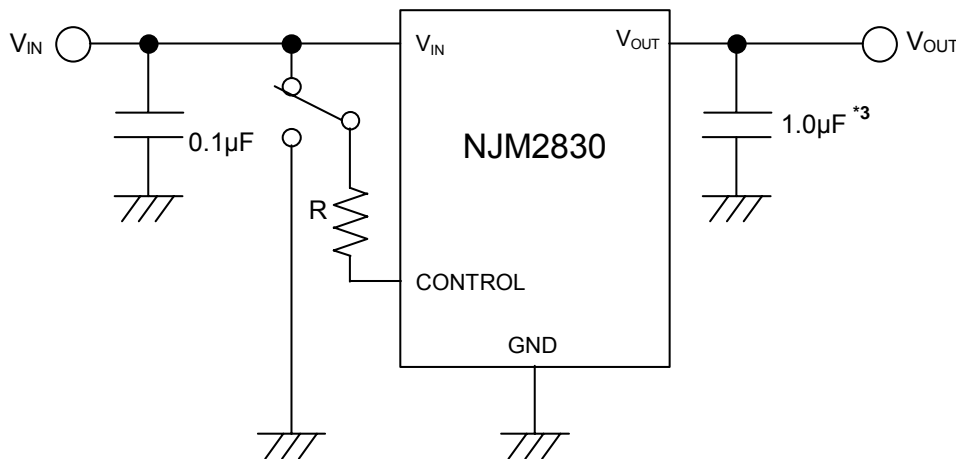

\*3 4.9V<V<sub>o</sub>≤5.5V version: C<sub>o</sub>=2.2µF(ceramic)  
 2.9V<V<sub>o</sub>≤4.9V version: C<sub>o</sub>=4.7µF(ceramic)  
 V<sub>o</sub>≤2.9V version: C<sub>o</sub>=10µF(ceramic)

State of control terminal:

- “H”→ output is enabled.
- “L” or “open” → output is disabled.

### \*In the case of using a resistance "R" between V<sub>IN</sub> and control.

The current flow into the control terminal while the IC is ON state (I<sub>CONT</sub>) can be reduced when a pull up resistance "R" is inserted between V<sub>IN</sub> and the control terminal.

The minimum control voltage for ON state (V<sub>CONT(ON)</sub>) is increased due to the voltage drop caused by I<sub>CONT</sub> and the resistance "R". The I<sub>CONT</sub> is temperature dependence as shown in the "Control Current vs. Temperature" characteristics. Therefore, the resistance "R" should be carefully selected to ensure the control voltage exceeds the V<sub>CONT(ON)</sub> over the required temperature range.

### \*Input Capacitance C<sub>IN</sub>

Input capacitance C<sub>IN</sub> is required to prevent oscillation and reduce power supply ripple for applications with high power supply impedance or a long power supply line.

Use the C<sub>IN</sub> value of 0.1µF greater to avoid the problem.

C<sub>IN</sub> should connect between GND and V<sub>IN</sub> as short as possible.

### \*Output Capacitance C<sub>O</sub>

Output capacitor (C<sub>o</sub>) is required for a phase compensation of the internal error amplifier. The capacitance and the equivalent series resistance (ESR) influences stability of the regulator.

This product is designed to work with a low ESR capacitor for the C<sub>o</sub>; however, use of recommended capacitance or greater value is essential for stable operation.

Use of a smaller C<sub>o</sub> may cause excess output noise or oscillation of the regulator due to lack of the phase compensation.

Therefore, use C<sub>o</sub> with the recommended capacitance or greater value and connect between V<sub>o</sub> terminal and GND terminal with minimal wiring. The recommended capacitance depends on the output voltage. Low voltage regulator requires greater value of the C<sub>o</sub>. Thus, check the recommended capacitance for each output voltage.

Use of a greater C<sub>o</sub> reduces output noise and ripple output, and also improves transient response of the output voltage against rapid load change.

# NJM2830

## ■ TYPICAL CHARACTERISTICS

### ● DC CHARACTERISTICS (3V Version)

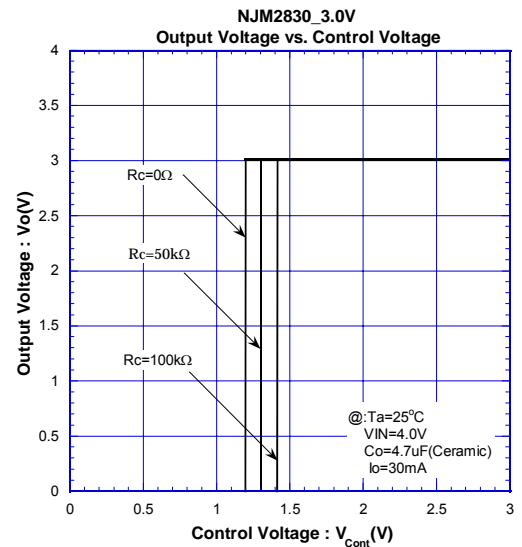
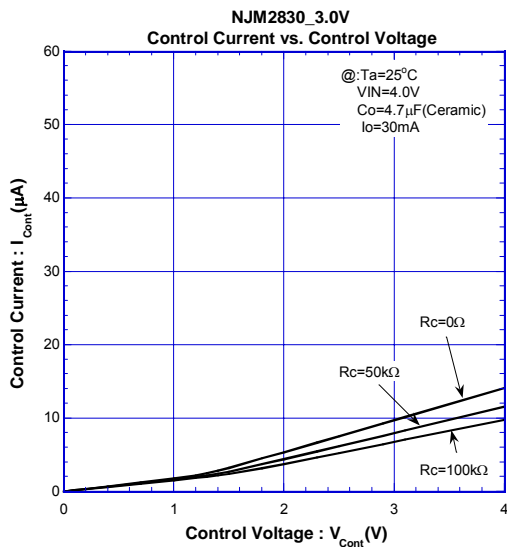
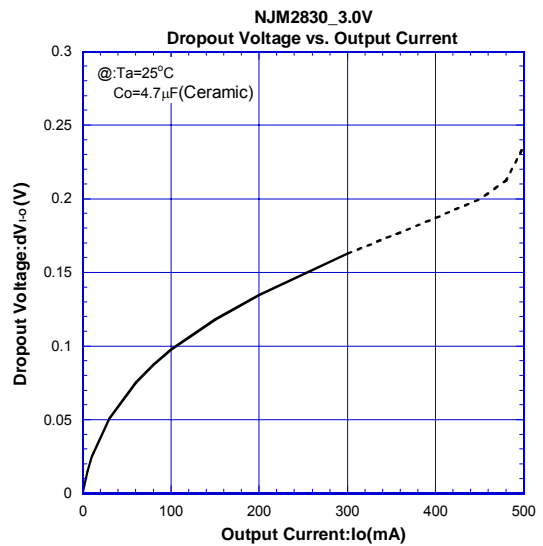
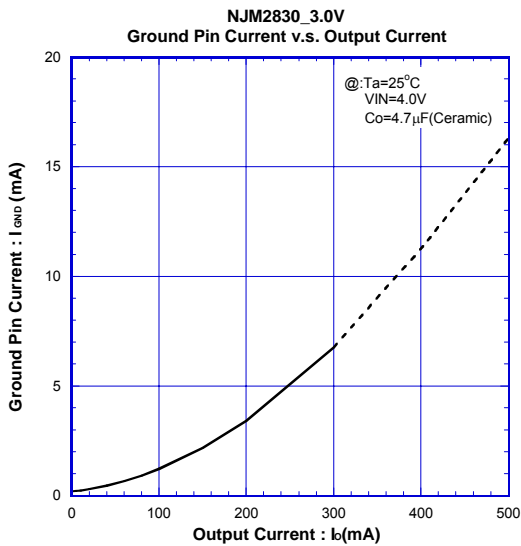
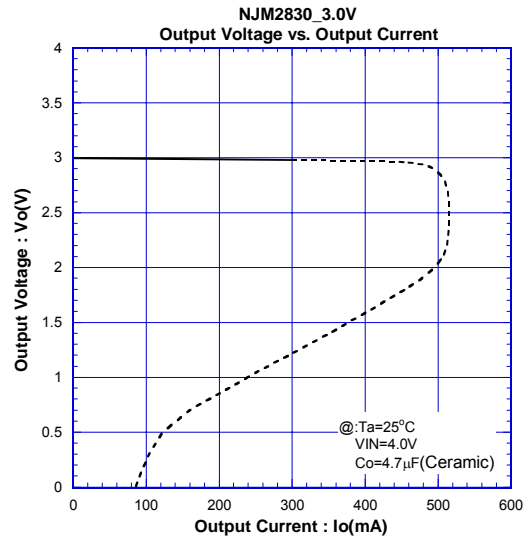
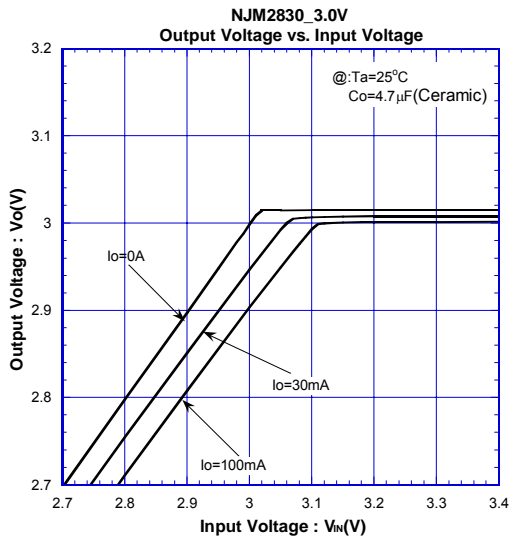

## TYPICAL CHARACTERISTICS

### DC CHARACTERISTICS (3V Version)

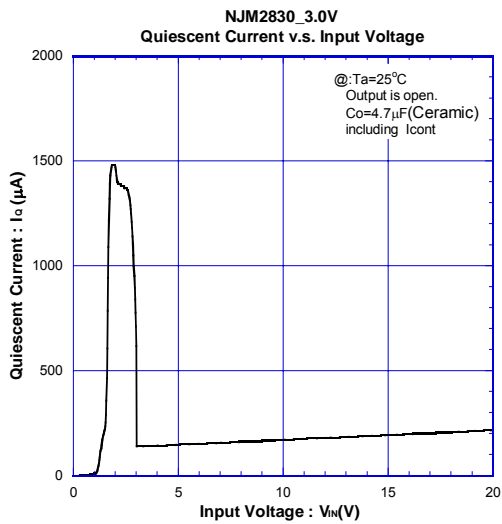
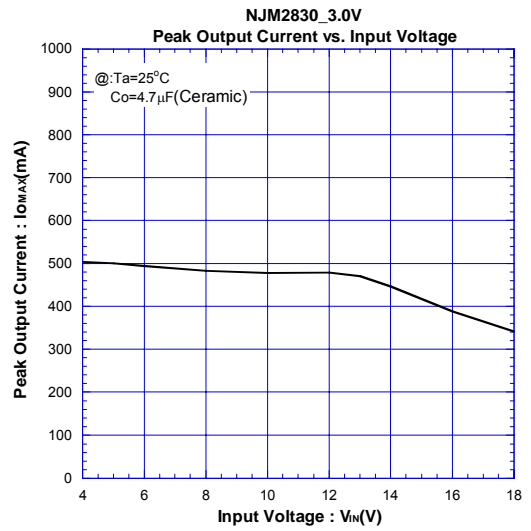
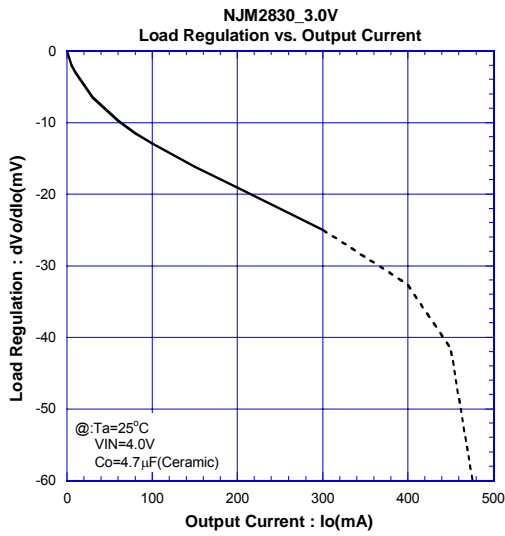

# NJM2830

## TYPICAL CHARACTERISTICS

### AC CHARACTERISTICS (3V Version)

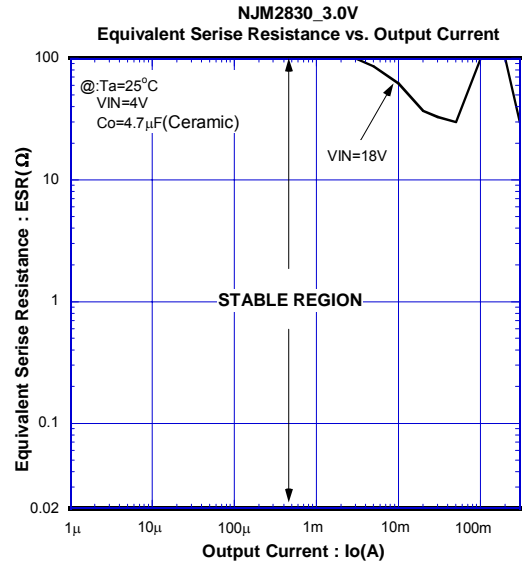
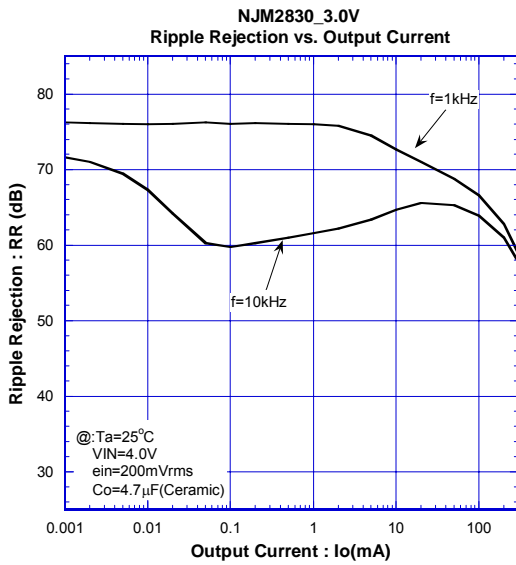
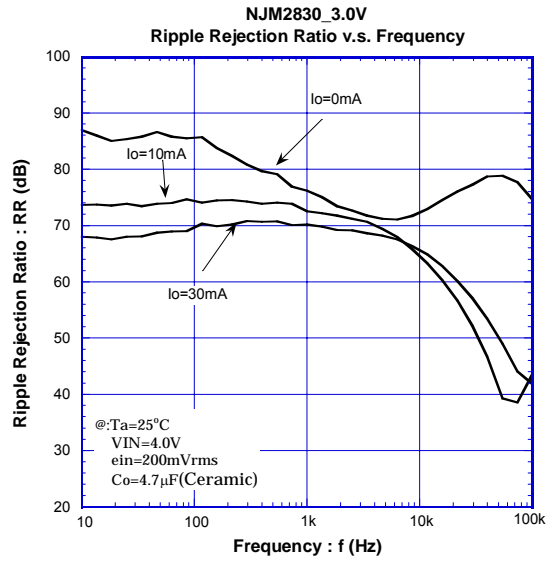
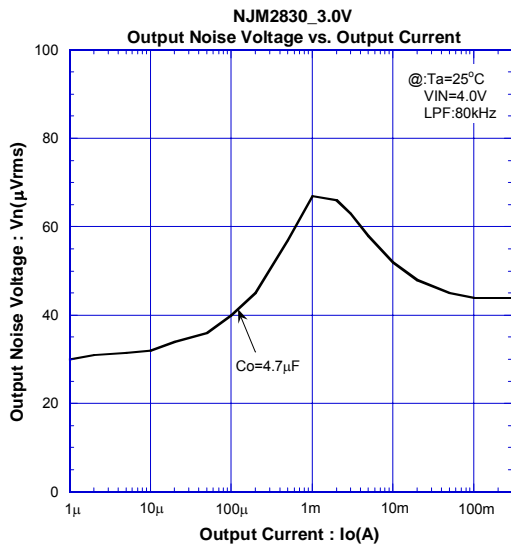



## TYPICAL CHARACTERISTICS

### ● TEMPERATURE CHARACTERISTICS (3V Version)

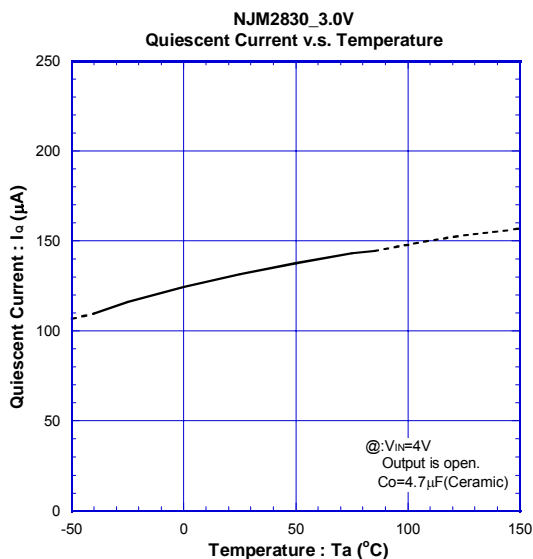
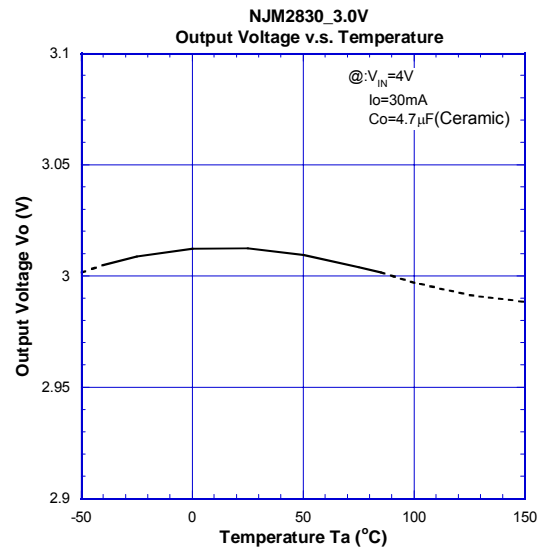
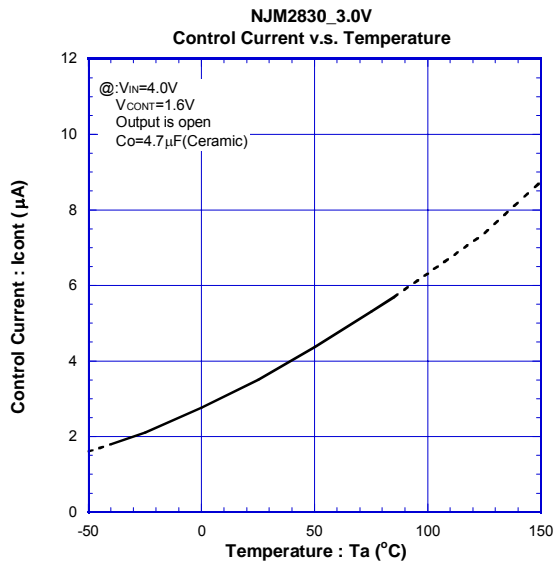
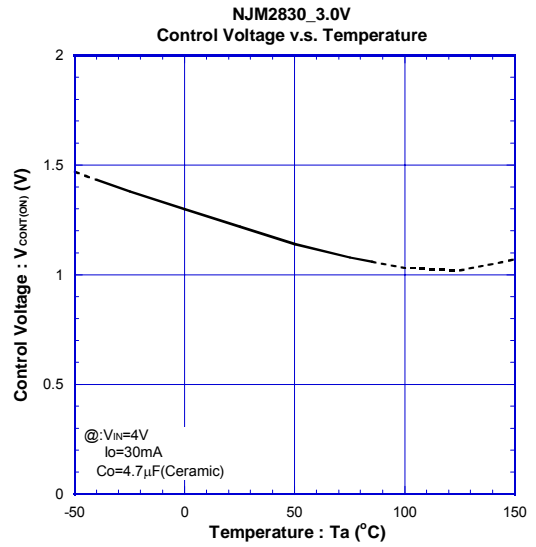
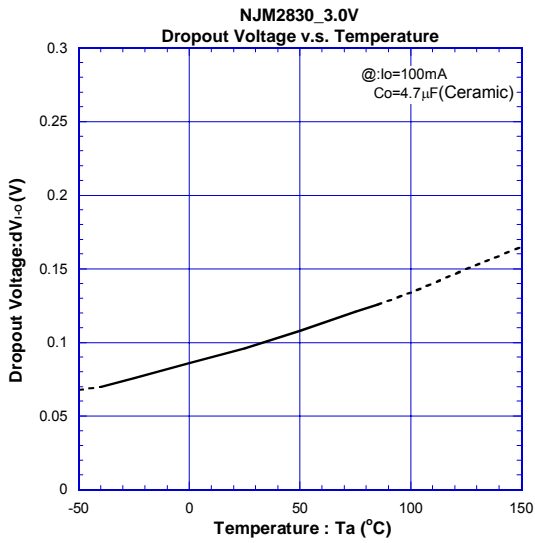

# NJM2830

## TYPICAL CHARACTERISTICS

### TEMPERATURE CHARACTERISTICS (3V Version)

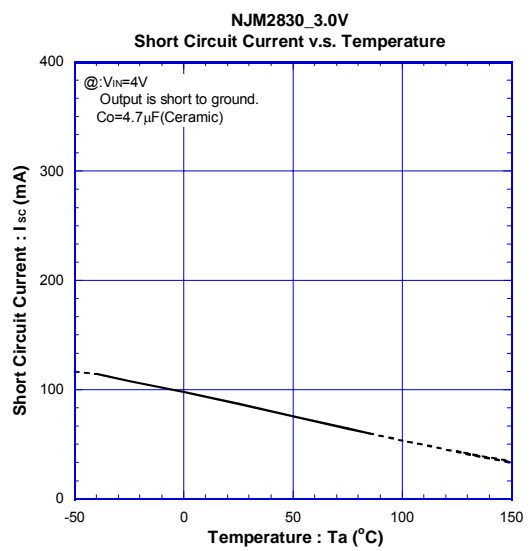
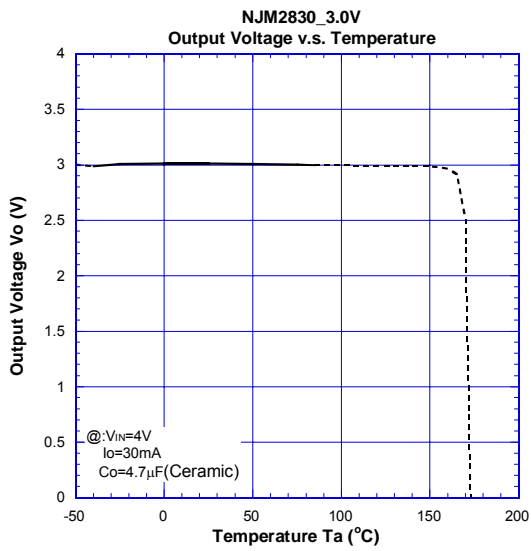
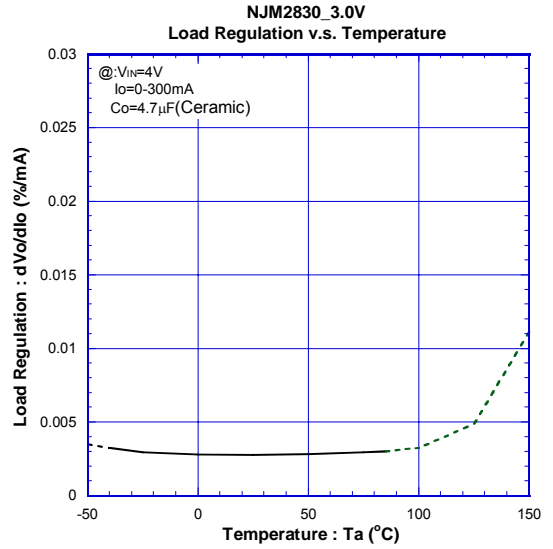
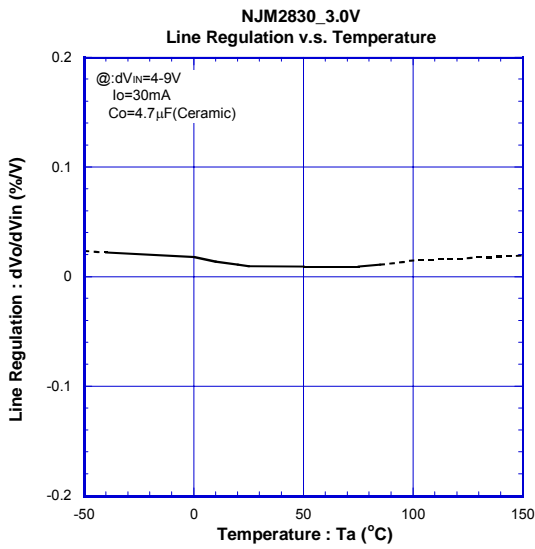

## TYPICAL CHARACTERISTICS

### ● TRANSIENT RESPONSE (3V Version)

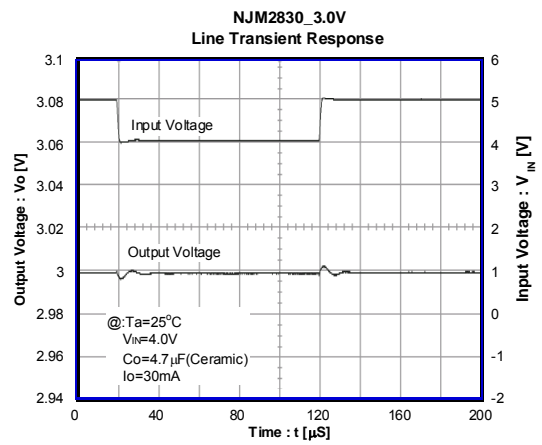
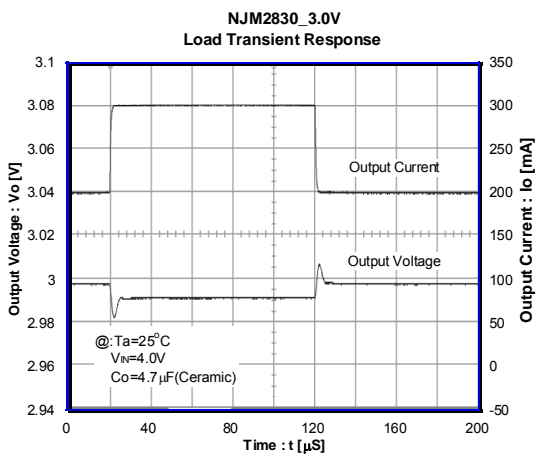
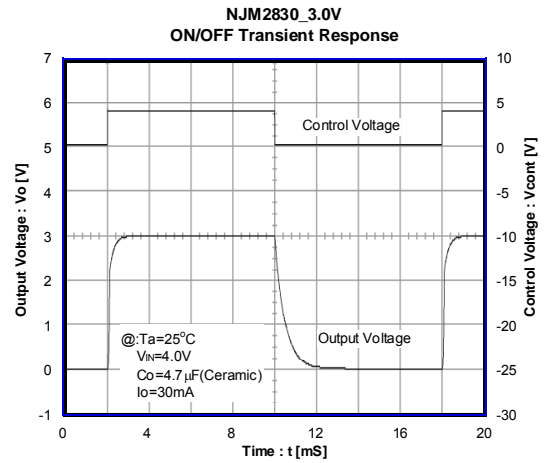
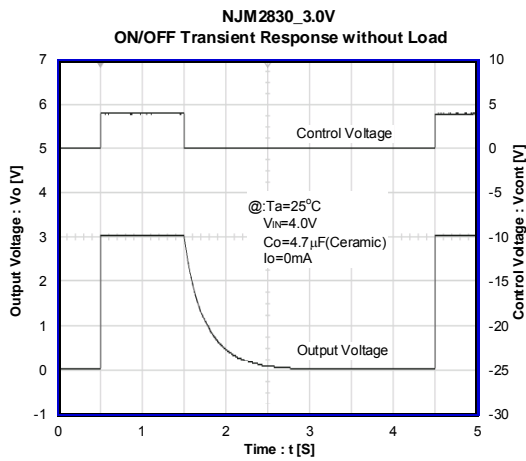

# NJM2830

## ■ TYPICAL CHARACTERISTICS

### ● DC CHARACTERISTICS (8.5V Version)

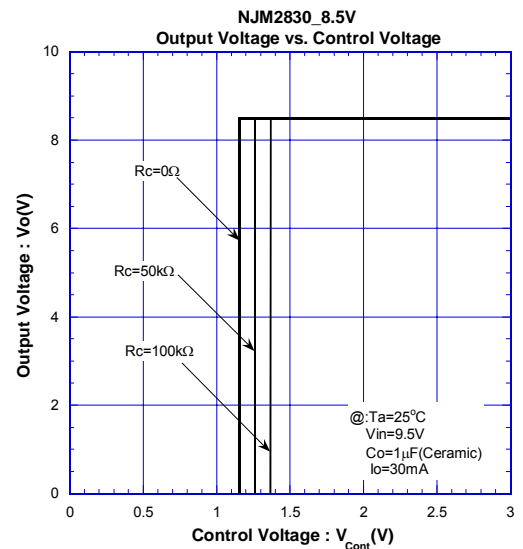
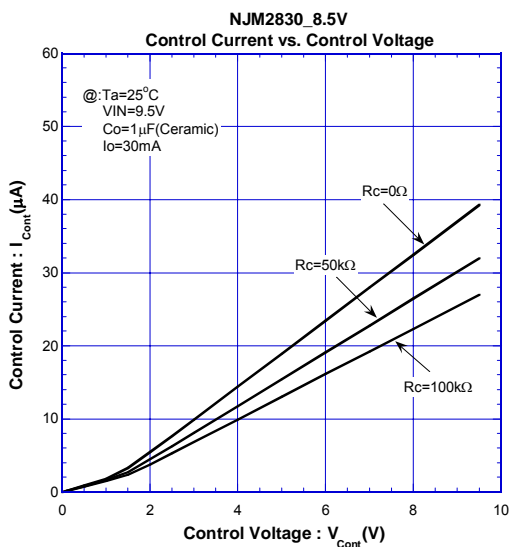
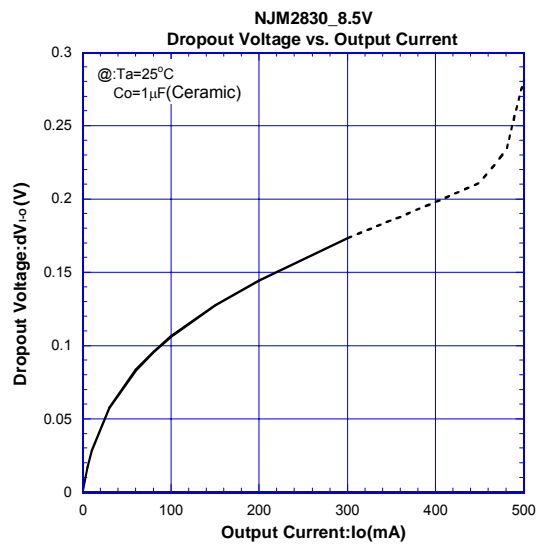
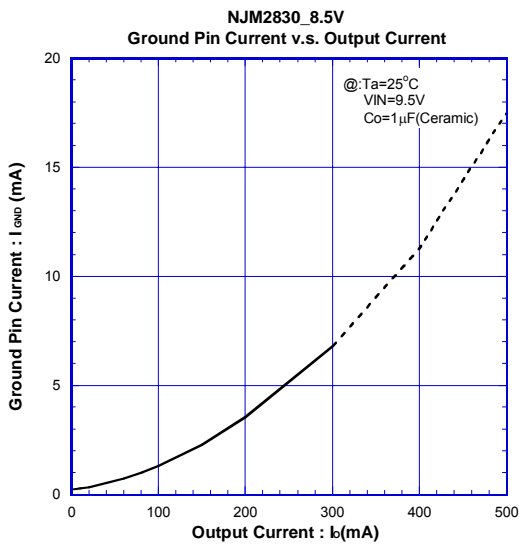
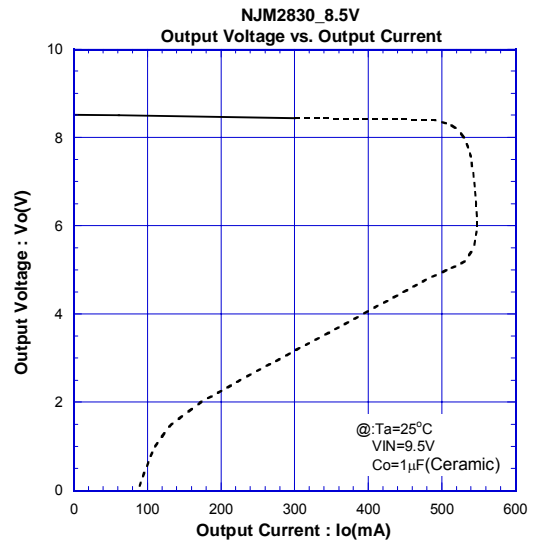
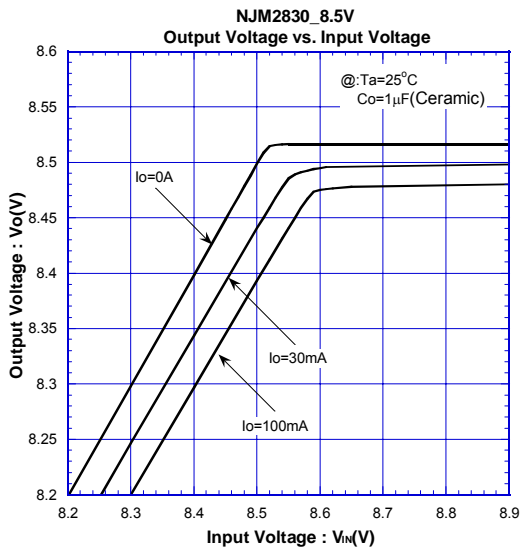

## TYPICAL CHARACTERISTICS

### DC CHARACTERISTICS (8.5V Version)

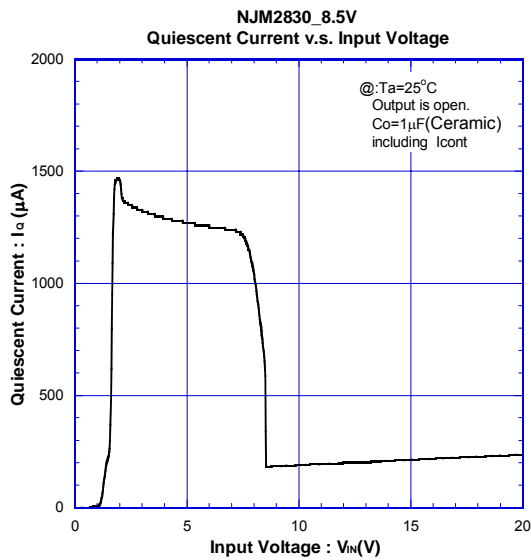
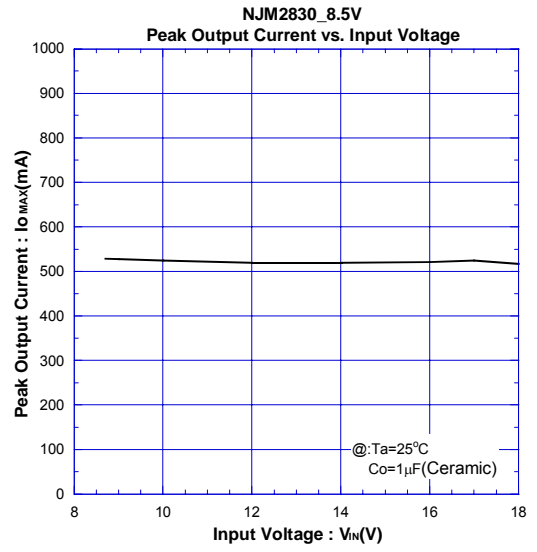
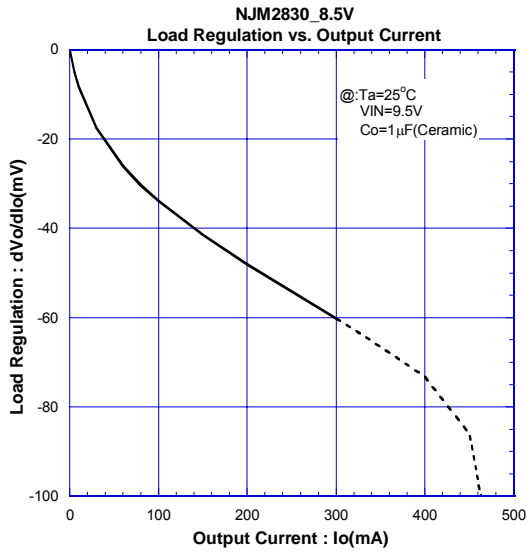

# NJM2830

## TYPICAL CHARACTERISTICS

### AC CHARACTERISTICS (8.5V Version)

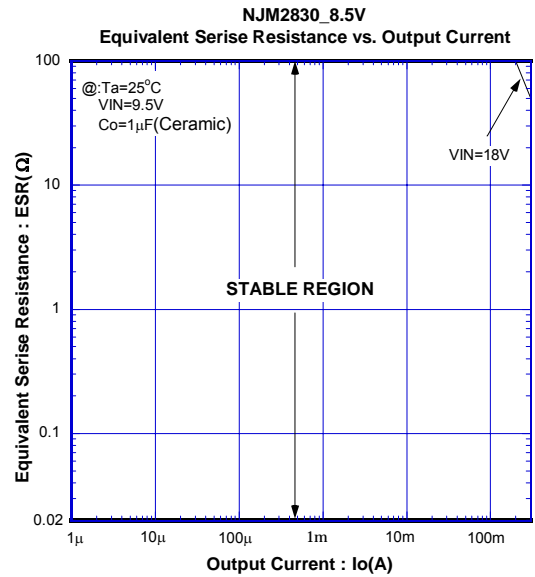
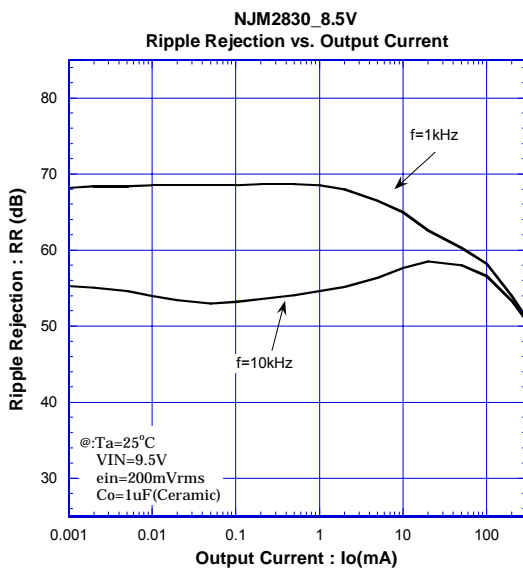
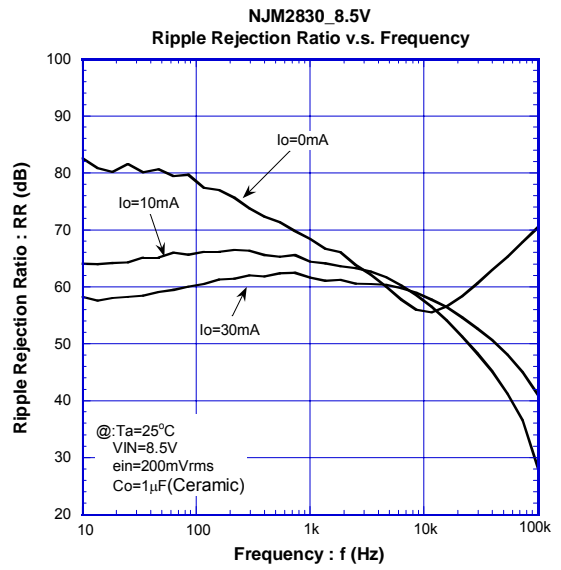
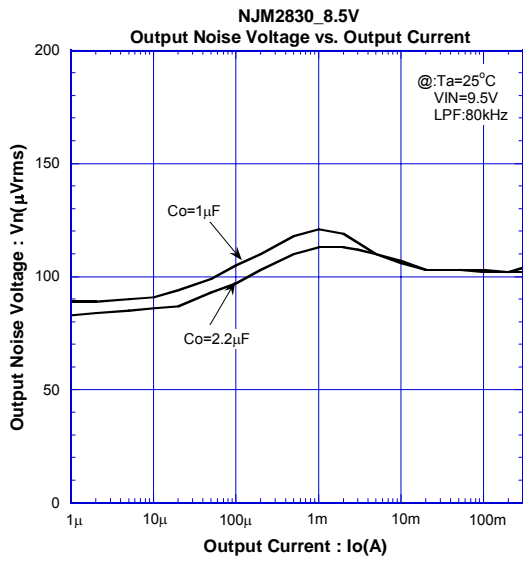

## ■ TYPICAL CHARACTERISTICS

### ● TEMPERATURE CHARACTERISTICS (8.5V Version)

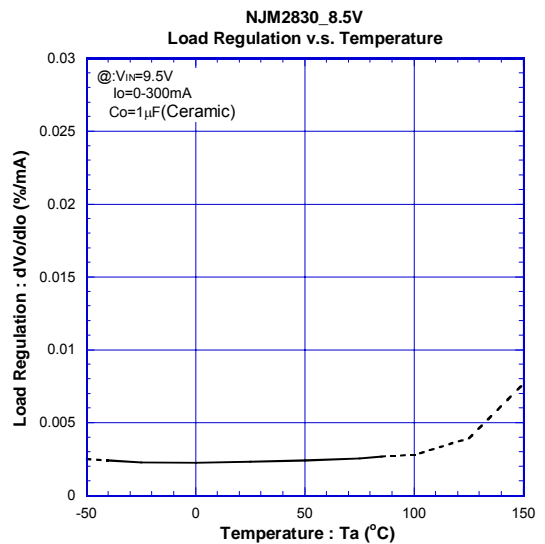
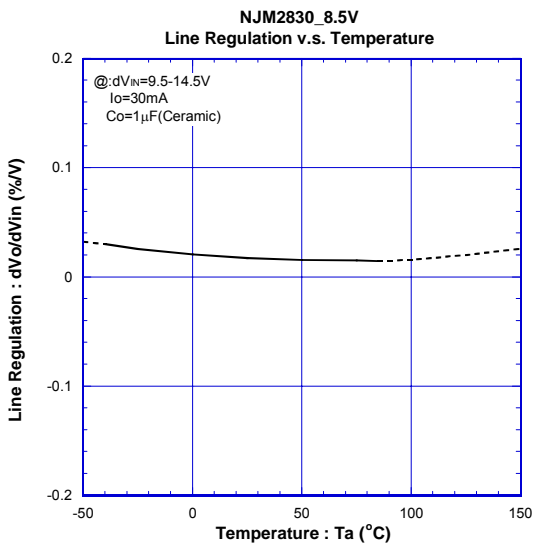
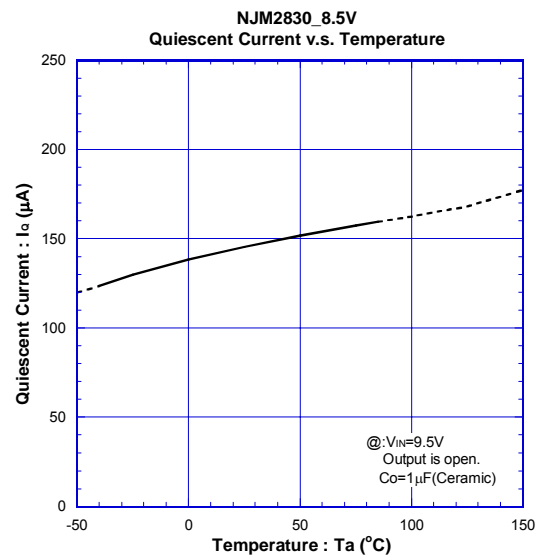
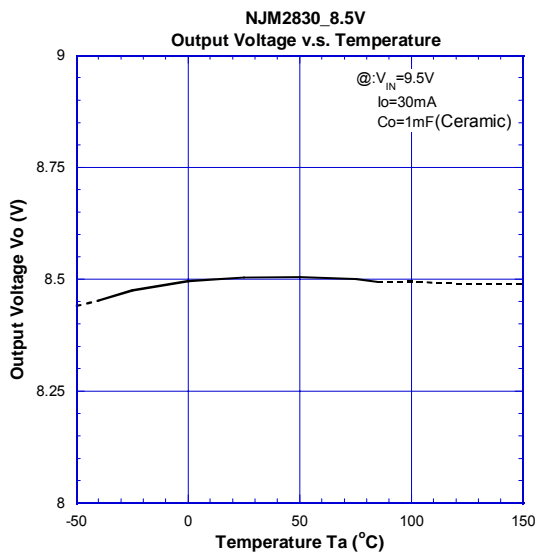
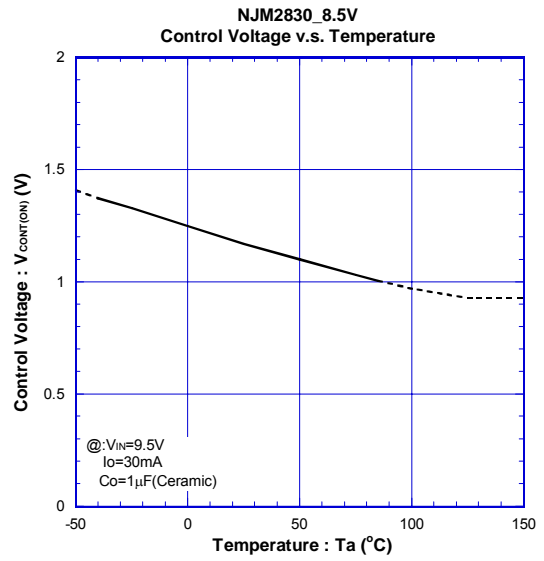
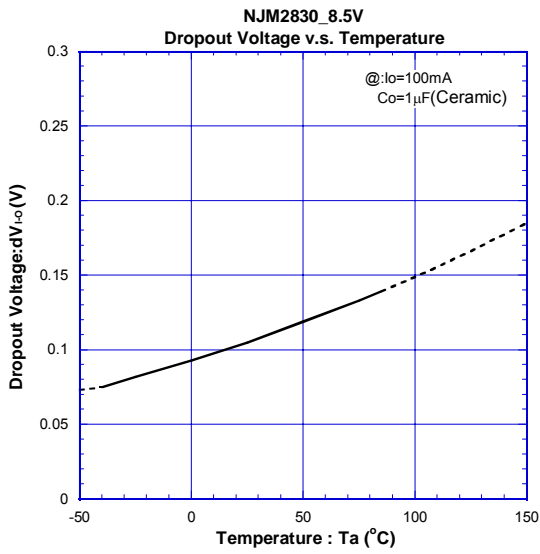

# NJM2830

## ■ TYPICAL CHARACTERISTICS

### ● TEMPERATURE CHARACTERISTICS (8.5V Version)

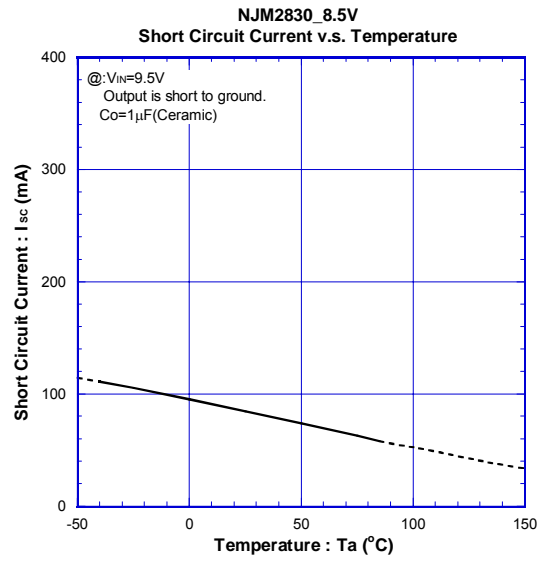
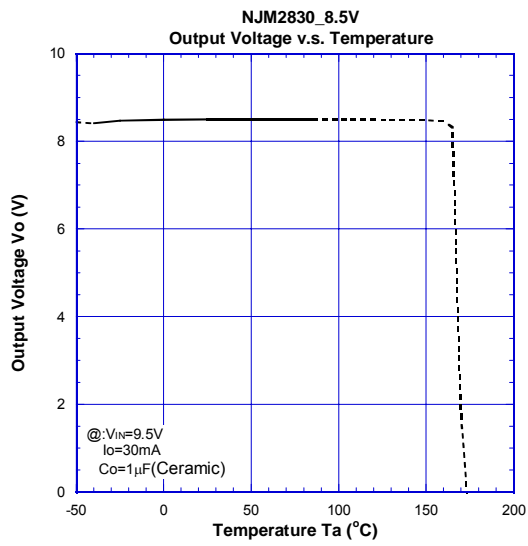

### ● TRANSIENT RESPONSE (8.5V Version)

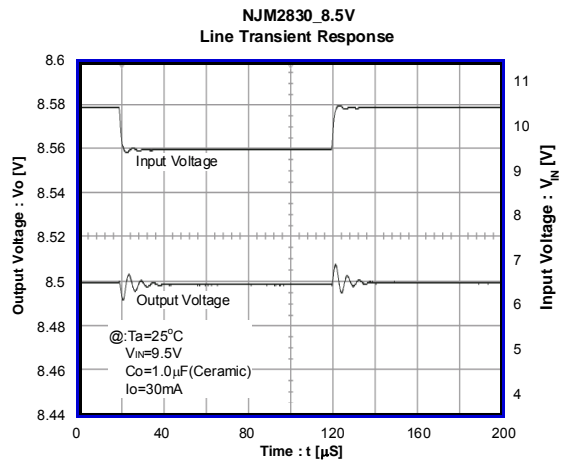
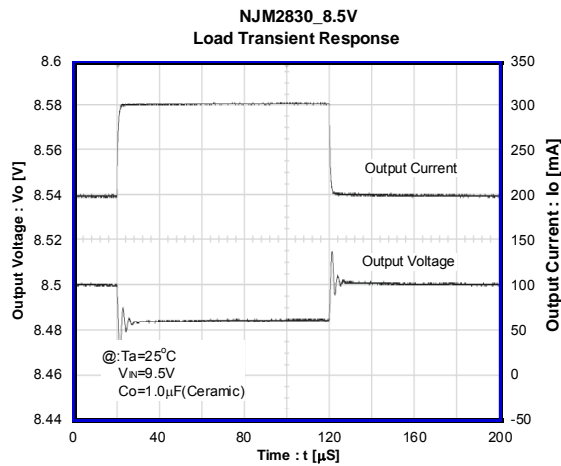
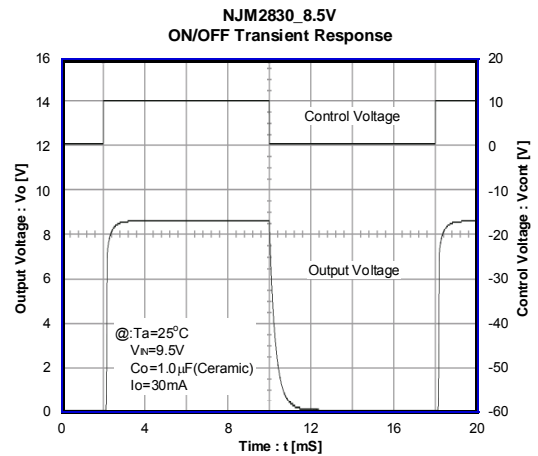
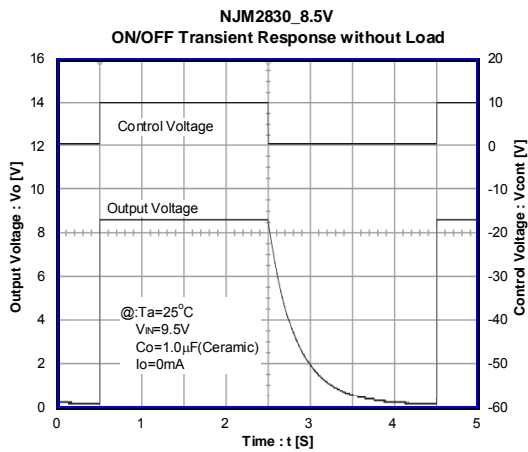



## ■ TYPICAL CHARACTERISTICS

### ● DC CHARACTERISTICS (15V Version)

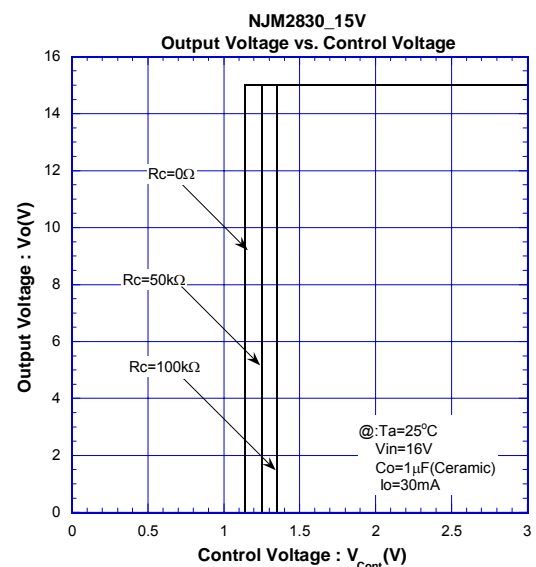
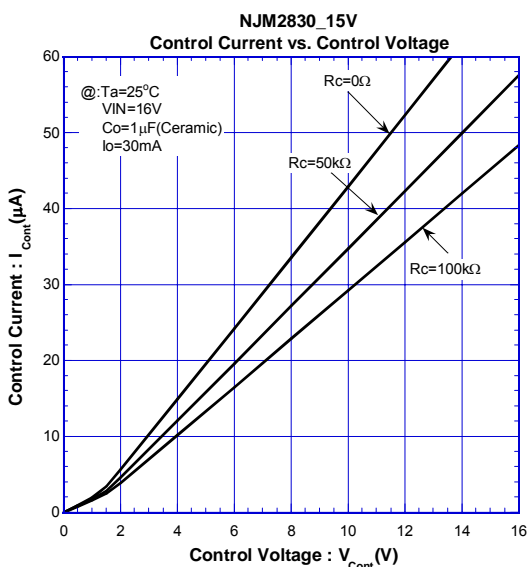
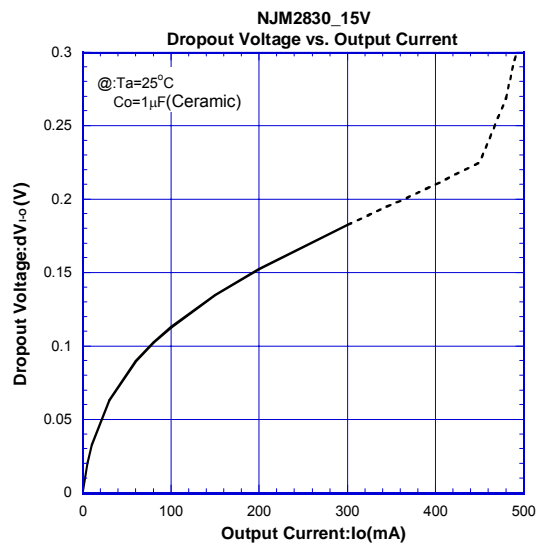
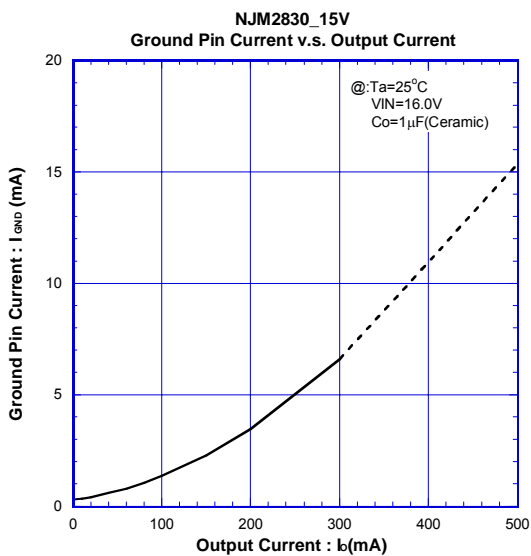
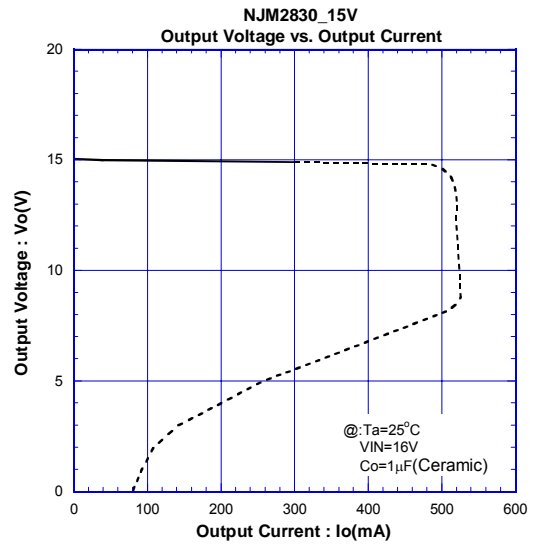
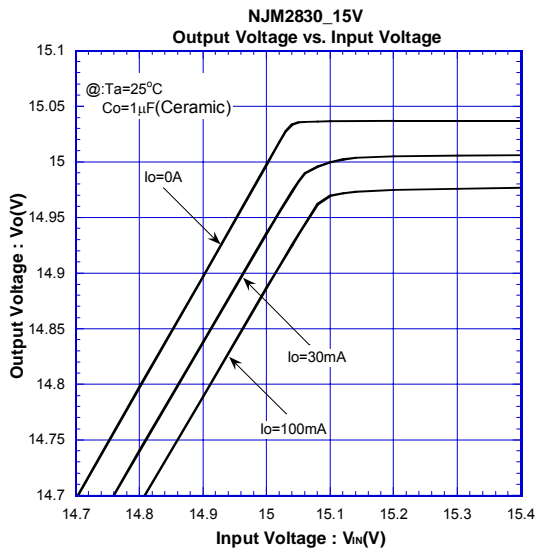

# NJM2830

## TYPICAL CHARACTERISTICS

### DC CHARACTERISTICS (15V Version)

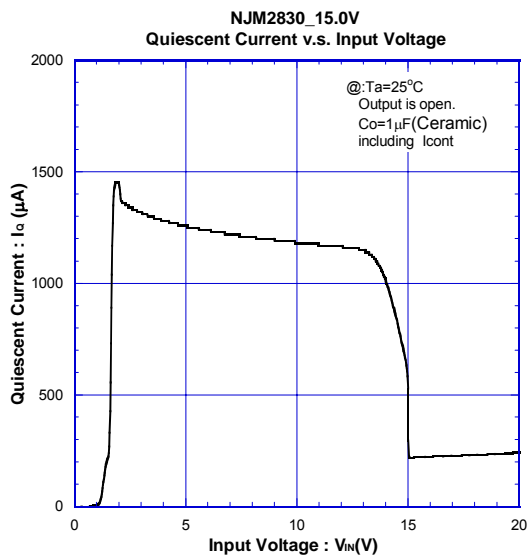
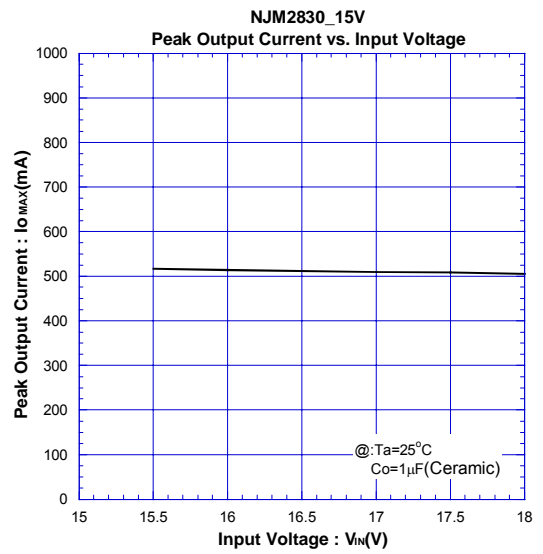
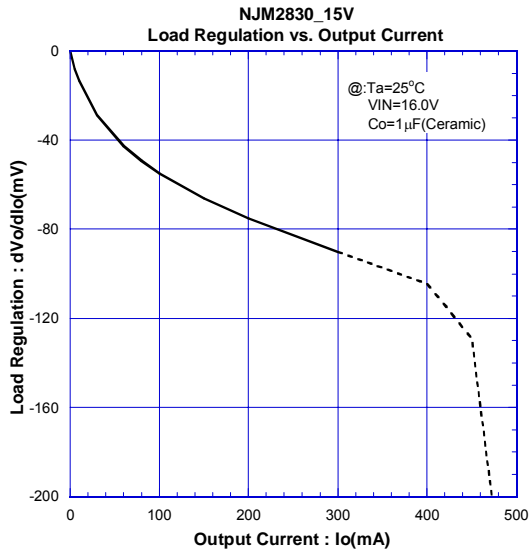

## TYPICAL CHARACTERISTICS

### AC CHARACTERISTICS (15V Version)

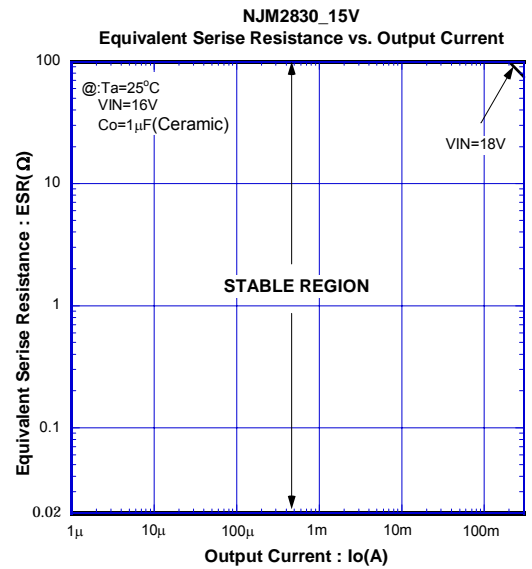
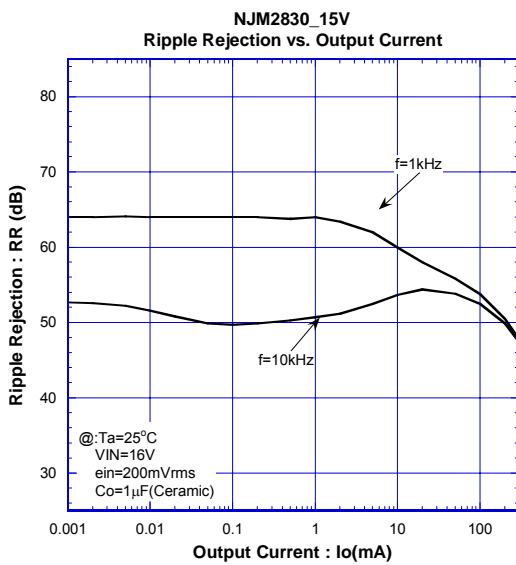
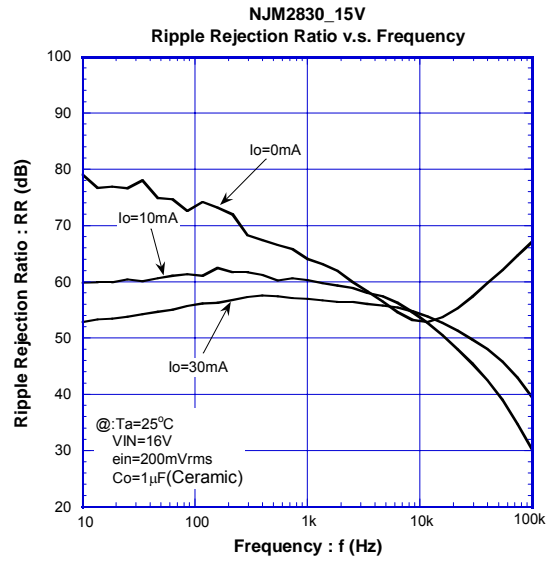
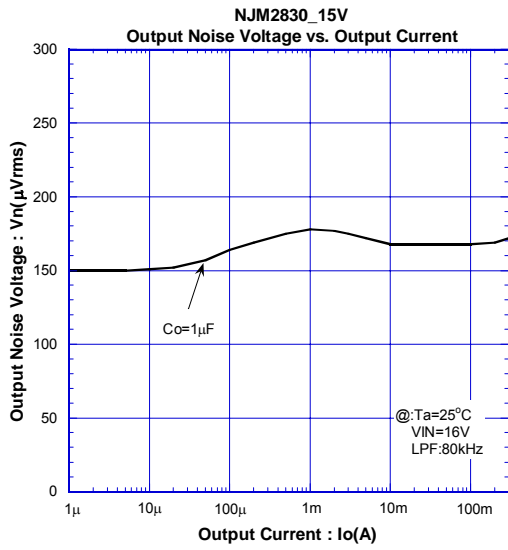

# NJM2830

## ■ TYPICAL CHARACTERISTICS

### ● TEMPERATURE CHARACTERISTICS (15V Version)

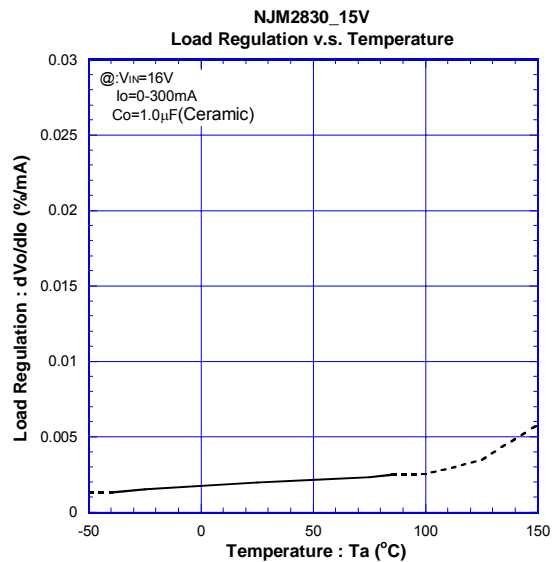
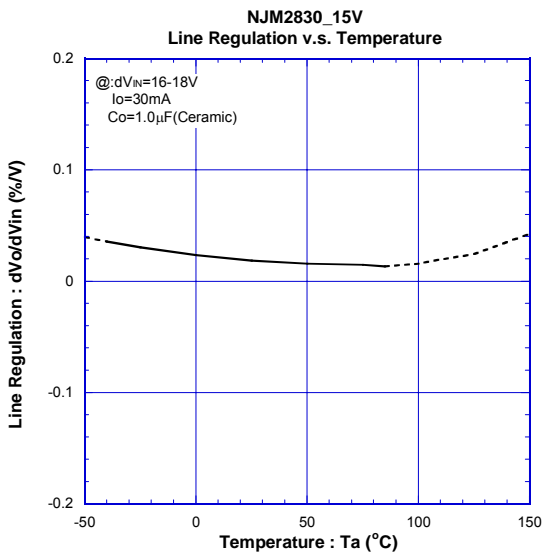
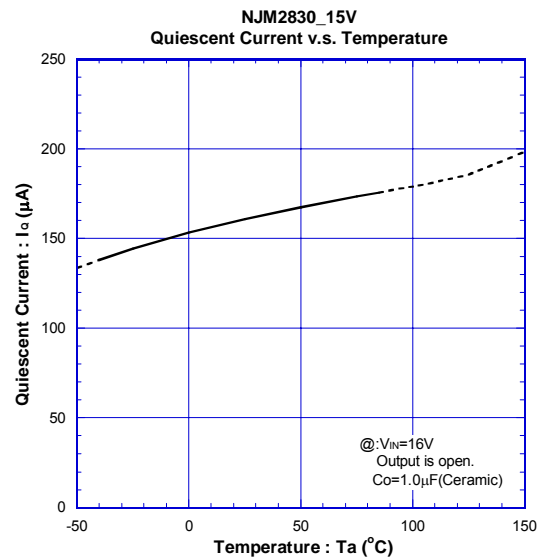
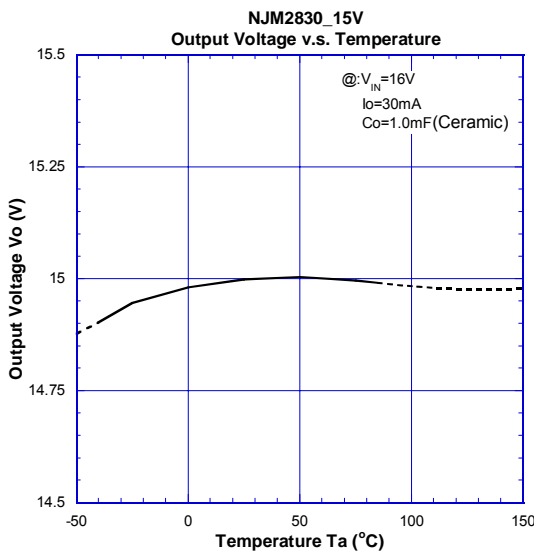
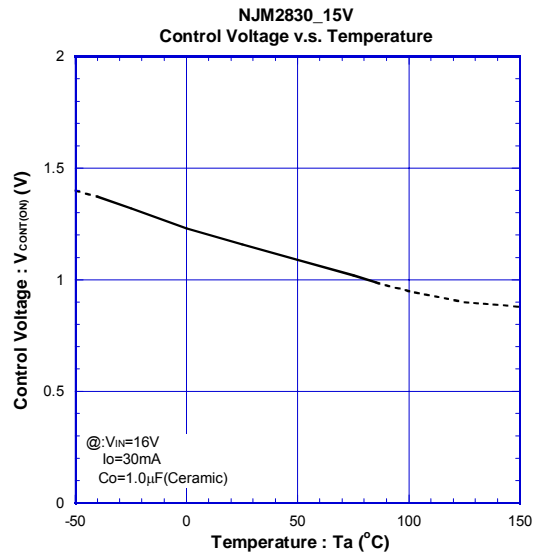
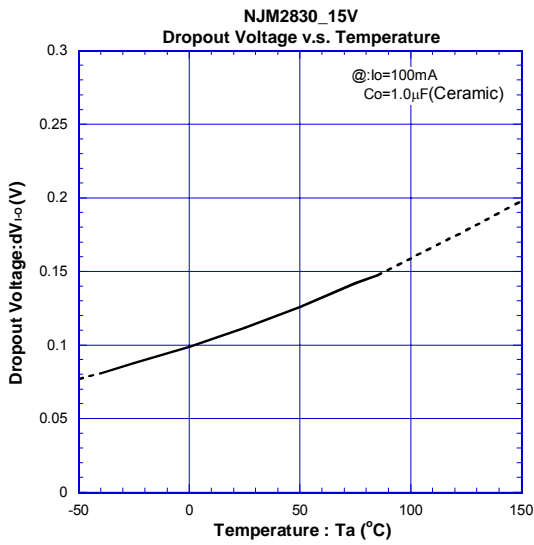

## ■ TYPICAL CHARACTERISTICS

### ● TEMPERATURE CHARACTERISTICS (15V Version)

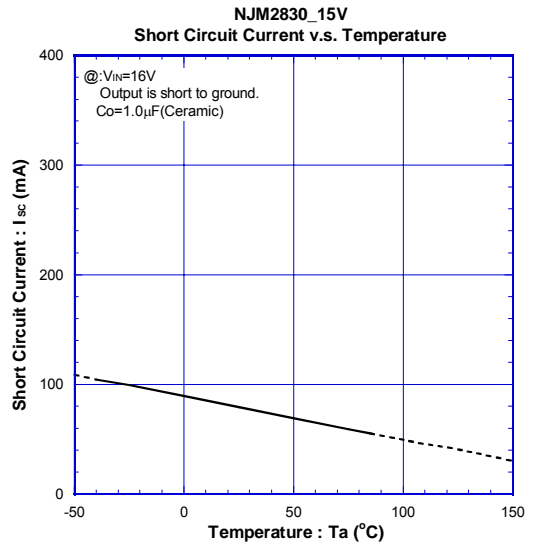
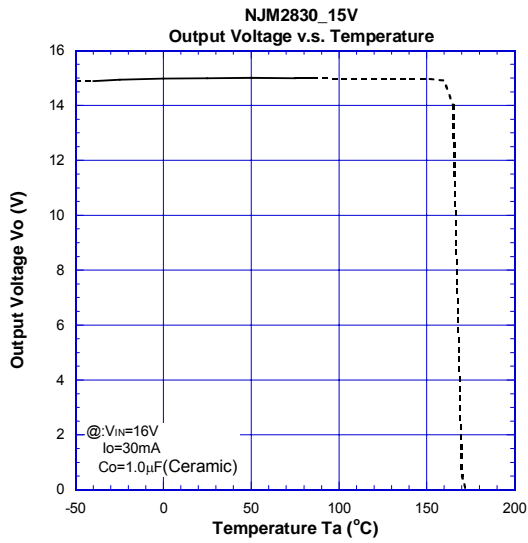

### ● TRANSIENT RESPONSE (15V Version)

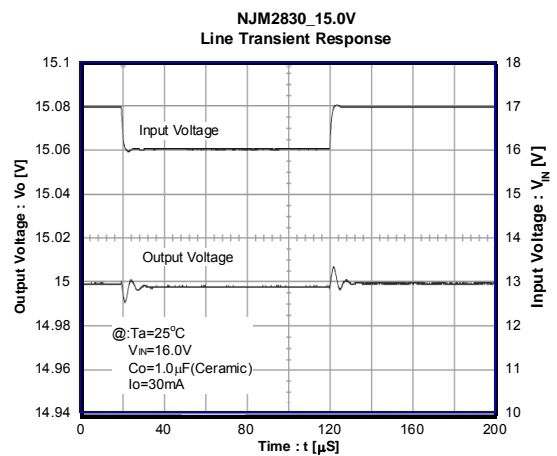
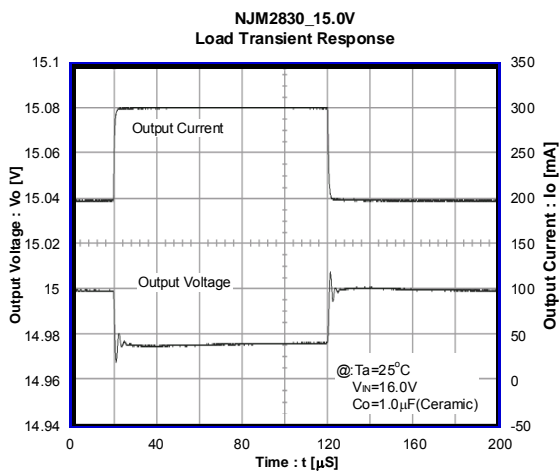
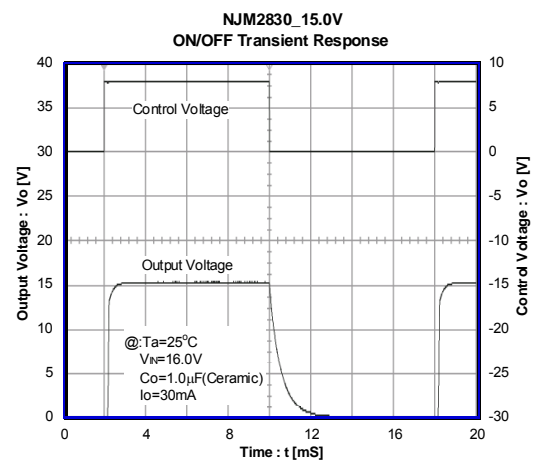
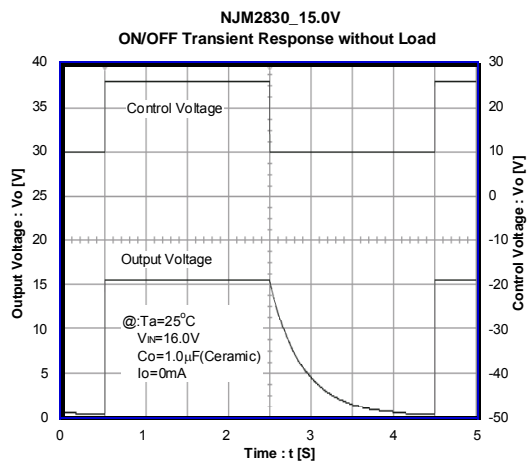

[CAUTION]

The specifications on this databook are only given for information, without any guarantee as regards either mistakes or omissions. The application circuits in this databook are described only to show representative usages of the product and not intended for the guarantee or permission of any right including the industrial rights.

# Mouser Electronics

Authorized Distributor

Click to View Pricing, Inventory, Delivery & Lifecycle Information:

[NJR:](#)

[NJM2830U1-TE1](#) [NJM2830U1-05-TE1](#)