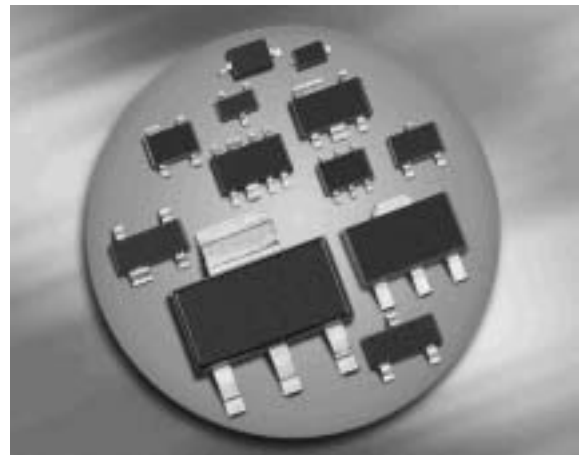
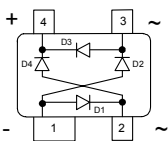

Low VF Schottky Diode Array

- Reverse voltage: 30 V
- Forward current: 0.9 A
- Small diode quad array for polarity independence, reverse polarity protection and low loss bridge rectification
- Very low forward voltage:
0.5 V typ. @ 0.7 A (per diode)
- Fast switching
- Pb-free (ROHS compliant) package¹⁾
- Qualified according AEC Q101

BAS3007A-RPP

Type	Package	Configuration	Marking
BAS3007A-RPP	SOT143	bridge	E1s

Maximum Ratings at $T_A = 25^\circ\text{C}$, unless otherwise specified

Parameter	Symbol	Value	Unit
Diode reverse voltage ²⁾	V_R	30	V
Peak reverse voltage ²⁾	V_{RM}	30	
RMS reverse voltage ²⁾	$V_{R(RMS)}$	21	
Forward current ²⁾ $T_S \leq 46^\circ\text{C}$ $T_S \leq 82^\circ\text{C}$	I_F	900 700	mA
Non-repetitive peak surge forward current ($t \leq 10$ ms)	I_{FSM}	5	A
Junction temperature	T_j	150	°C
Storage temperature	T_{stg}	-65 ... 150	

¹Pb-containing package may be available upon special request

²For $T_A > 25^\circ\text{C}$ the derating of V_R and I_F has to be considered. Please refer to the attached curves.

Thermal Resistance

Parameter	Symbol	Value	Unit
Junction - soldering point ¹⁾	R_{thJS}	≤ 95	K/W

Electrical Characteristics at $T_A = 25^\circ\text{C}$, unless otherwise specified

Parameter	Symbol	Values			Unit
		min.	typ.	max.	

DC Characteristics

Reverse current (per diode) ²⁾	I_R				μA
$V_R = 12\text{ V}$		-	-	30	
$V_R = 30\text{ V}$		-	-	350	
Forward voltage (per diode) ²⁾³⁾	V_F				V
$I_F = 100\text{ mA}$		-	0.35	0.4	
$I_F = 350\text{ mA}$		-	0.4	0.5	
$I_F = 500\text{ mA}$		-	0.45	0.55	
$I_F = 700\text{ mA}$		-	0.5	0.6	
$I_F = 900\text{ mA}$		-	0.6	0.7	

AC Characteristics

Diode capacitance (per diode)	C_T	-	9	15	μF
$V_R = 5\text{ V}, f = 1\text{ MHz}$					

¹⁾For calculation of R_{thJA} please refer to Application Note Thermal Resistance

²⁾Pulsed test, $t_p = 300\ \mu\text{s}$; $D = 0.01$

³⁾When used as shown for Reverse Polarity Protection (RPP, see page 4), the voltage available to the circuit being protected will be two diode drops below the power supply voltage. In other words, the supply current will pass through two diodes.

Diode capacitance $C_T = f(V_R)$

$f = 1\text{MHz}$ (per diode)

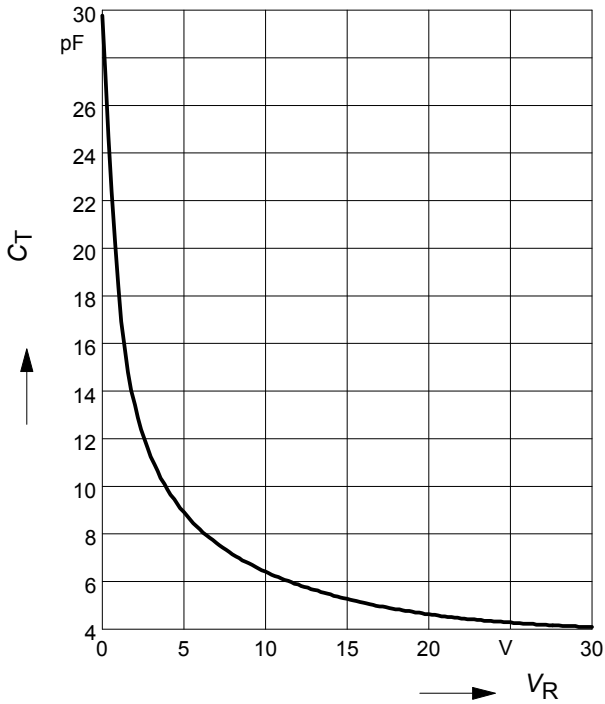

Forward Voltage $V_F = f(T_A)$

$I_F = \text{Parameter}$ (per diode)

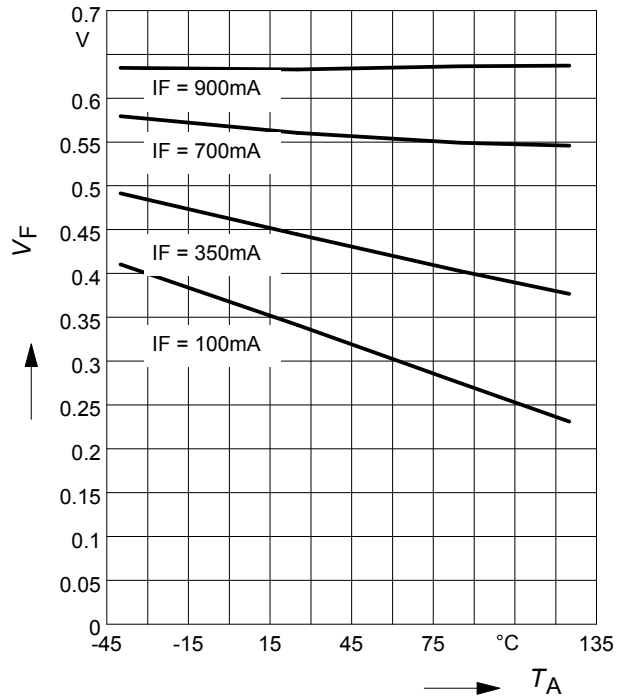

Forward current $I_F = f(V_F)$

$T_A = \text{Parameter}$ (per diode)

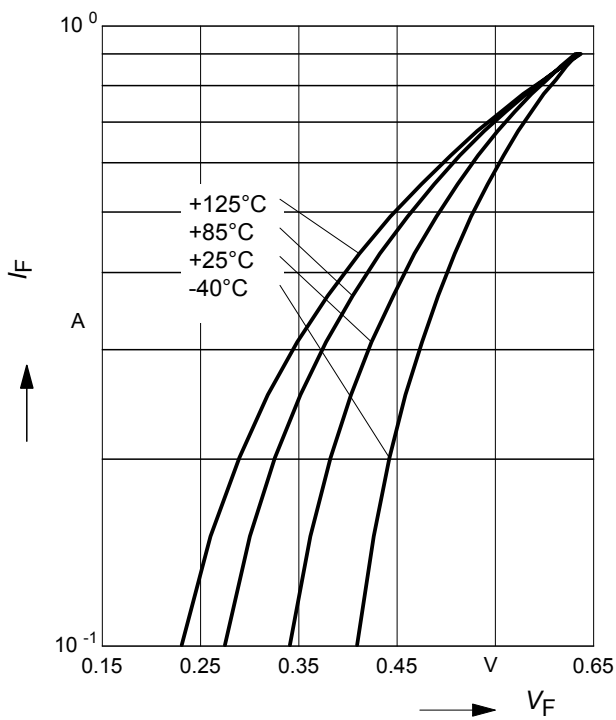

Permissible Reverse voltage $V_R = f(T_A)$

$t_p = \text{Parameter}$, Duty cycle < 0.01

Device mounted on PCB with $R_{th} = 160 \text{ K/W}$

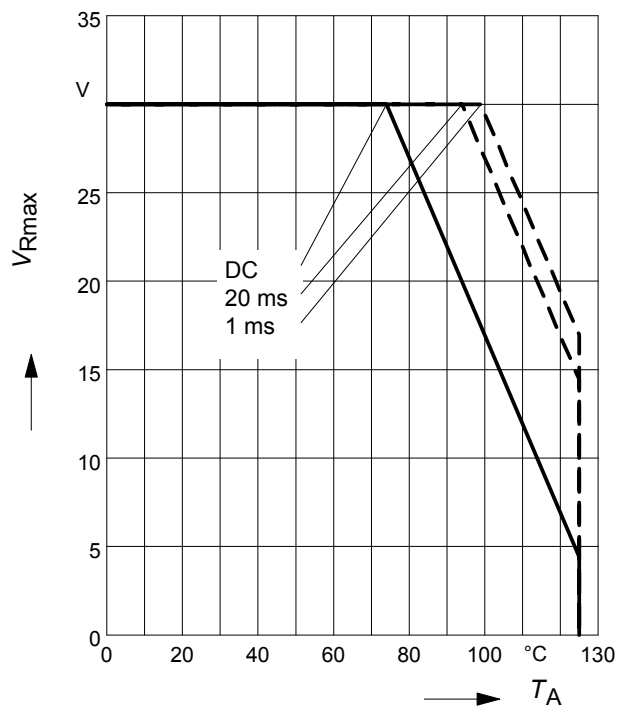

Forward current $I_F = f(T_S)$

Current flows through two chips

per package at the same time (per array)

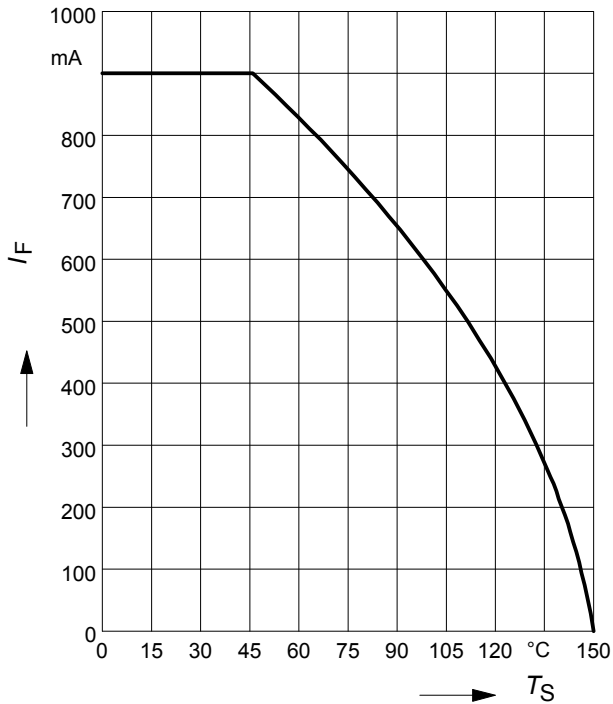
Application example BAS3007A-RPP

Advanced Reverse Polarity Protection(RPP): due to diode orientation, circuit at the right will be protected from damage and will also function normally in the event reverse polarity is applied to pins 2 and 3 of the BAS3007A-RPP.

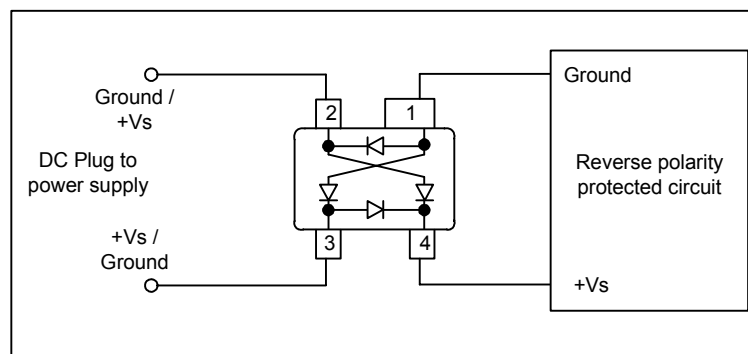

Package Outline



Foot Print

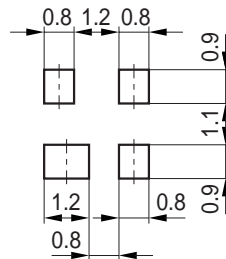

Marking Layout (Example)

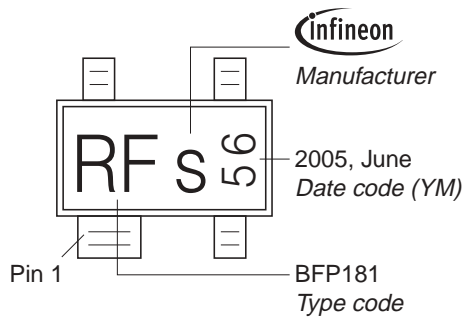

Standard Packing

Reel $\varnothing 180$ mm = 3.000 Pieces/Reel
 Reel $\varnothing 330$ mm = 10.000 Pieces/Reel



Edition 2006-02-01
Published by
Infineon Technologies AG
81726 München, Germany
© Infineon Technologies AG 2007.
All Rights Reserved.

Attention please!

The information given in this dokument shall in no event be regarded as a guarantee of conditions or characteristics ("Beschaffenheitsgarantie"). With respect to any examples or hints given herein, any typical values stated herein and/or any information regarding the application of the device, Infineon Technologies hereby disclaims any and all warranties and liabilities of any kind, including without limitation warranties of non-infringement of intellectual property rights of any third party.

Information

For further information on technology, delivery terms and conditions and prices please contact your nearest Infineon Technologies Office (www.infineon.com).

Warnings

Due to technical requirements components may contain dangerous substances. For information on the types in question please contact your nearest Infineon Technologies Office.

Infineon Technologies Components may only be used in life-support devices or systems with the express written approval of Infineon Technologies, if a failure of such components can reasonably be expected to cause the failure of that life-support device or system, or to affect the safety or effectiveness of that device or system.

Life support devices or systems are intended to be implanted in the human body, or to support and/or maintain and sustain and/or protect human life. If they fail, it is reasonable to assume that the health of the user or other persons may be endangered.

Mouser Electronics

Authorized Distributor

Click to View Pricing, Inventory, Delivery & Lifecycle Information:

[Infineon:](#)

[BAS 3007A-RPP E6327](#)