

PART NUMBER	SSL-LXA228SRC-TR31	REV.	G
DATE	E.C.N. NUMBER AND REVISION COMMENTS		REV.
10.12.95	CHG'D. LENS LOCATION TO FIT SR STYLE.		A
01.05.01	E.C.N. #10695. &10BRDR.		B
05.31.01	E.C.N. #10745.		C
06.18.01	E.C.N. #10762.		D
09.07.01	E.C.N. #10784.		E
11.15.06	E.C.N. #11148.		F
10.14.10	E.C.N. #11668.		G

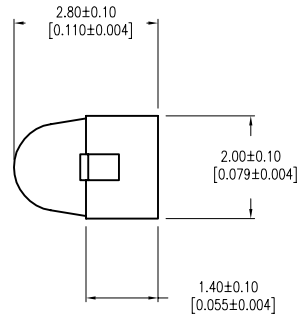

**C** ELECTRO-OPTICAL CHARACTERISTICS  $T_A=25^\circ\text{C}$   $I_f=20\text{mA}$

PARAMETER	MIN	TYP	MAX	UNITS	TEST COND
PEAK WAVELENGTH		660		nm	
FORWARD VOLTAGE		1.7	2.2	$V_f$	
REVERSE VOLTAGE	5.0			$V_r$	$I_f=100\mu\text{A}$
<b>G</b> AXIAL INTENSITY	75	100		mcd	$I_f=20\text{mA}$
VIEWING ANGLE		25		$2x$ theta	
EMITTED COLOR:	RED				
EPOXY LENS FINISH:	WATER CLEAR				

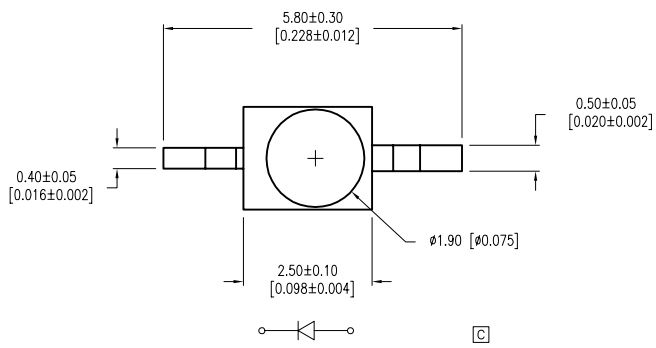
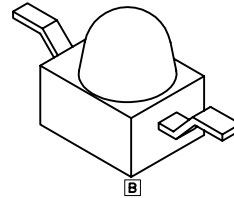
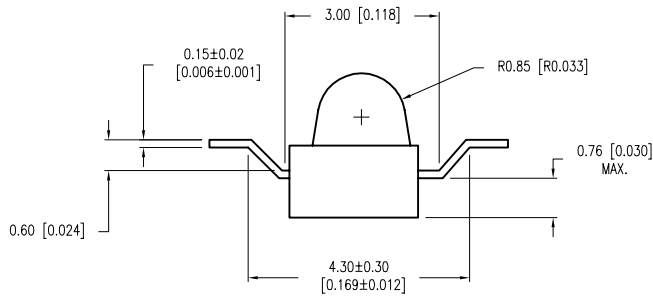

**C** LIMITS OF SAFE OPERATION AT 25°C PER DIE

PARAMETER	MAX	UNITS
PEAK FORWARD CURRENT*	160	mA
STEADY CURRENT	25	mA
POWER DISSIPATION	60	mW
DERATE FROM 25°C	-1.2	mW/°C
OPERATING TEMP.	-40 TO +85	°C
STORAGE TEMP.	-40 TO +85	°C

\*  $t < 10\mu\text{s}$

NOTES:

- 1,000 PIECES PER REEL.
- THE CATHODE IS ORIENTED TOWARDS THE TAPE SPROCKET HOLE.

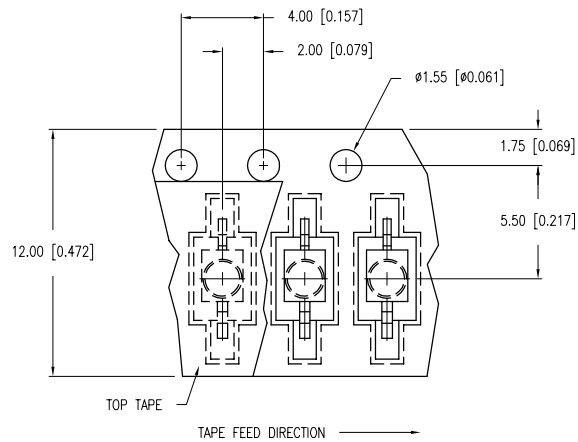

**D** RECOMMENDED SOLDER PAD LAYOUT

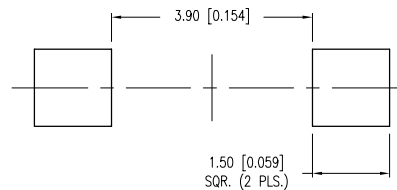

LEAD FREE REFLOW PROFILE

10 SEC. MAX.

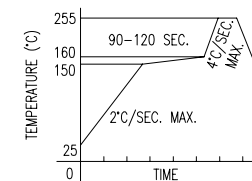

TOTAL TIME ABOVE 220°C IS 60 SECONDS MAX.

\*UNLESS OTHERWISE SPECIFIED TOLERANCES PER DECIMAL PRECISION ARE: X=±1 (±0.039), X.X=±0.5 (±0.020), X.XX=±0.25 (±0.010), X.XXX=±0.127 (±0.005). LEAD SIZE=±0.05 (±0.002), LEAD LENGTH=±0.75 (±0.030). MIN.= +DECIMAL PRECISION -0.00 MAX.= +0.00 -DECIMAL PRECISION UNCONTROLLED DOCUMENT

**LUMEX**  
 Creating LED and LCD Solutions Together™  
 290 E. HELEN ROAD  
 PALATINE, IL 60067-6976  
 PHONE: +1.847.359.2790  
 FAX: +1.847.359.6538  
 WEB: WWW.LUMEX.COM

660nm SUPER RED, AXIAL LED, WATER CLEAR LENS, Z BEND, TAPE AND REEL.

\*\*THE SPECIFICATIONS MAY CHANGE AT ANY TIME WITHOUT NOTICE DUE TO NEW MATERIALS OR PRODUCT IMPROVEMENT.\*\*

CONFIDENTIAL INFORMATION  
 THE INFORMATION CONTAINED IN THIS DOCUMENT IS THE PROPERTY OF LUMEX INC. EXCEPT AS SPECIFICALLY AUTHORIZED IN WRITING BY LUMEX INC., THE HOLDER OF THIS DOCUMENT SHALL KEEP ALL INFORMATION CONTAINED HEREIN CONFIDENTIAL AND SHALL PROTECT SAME IN WHOLE OR IN PART FROM DISCLOSURE AND DISSEMINATION TO ALL THIRD PARTIES.

DATE:	11.15.08	DRAWN BY:	JH
PAGE:	1 OF 1	CHKD BY:	SS
SCALE:	N/A	APRVD BY:	KF
UNIT:	mm [INCH]		

# Mouser Electronics

Authorized Distributor

Click to View Pricing, Inventory, Delivery & Lifecycle Information:

Lumex:

[SSL-LXA228SRC-TR31](#)