

Single/Dual 145 μ A, 9.5nV/ $\sqrt{\text{Hz}}$, $A_V \geq 5$, Rail-to-Rail Output Precision Op Amps

FEATURES

- 35 μ V Maximum Offset Voltage (LT6013A)
- Low 1/f Noise: 200nV_{P-P} (0.1Hz to 10Hz)
40nV_{RMS} (0.1Hz to 10Hz)
- Low White Noise: 9.5nV/ $\sqrt{\text{Hz}}$ (1kHz)
- Rail-to-Rail Output Swing
- 145 μ A Supply Current per Amplifier
- 250pA Maximum Input Bias Current (LT6013A)
- $A_V \geq 5$ Stable; Up to 500pF C_{LOAD}
- 0.2V/ μ s Slew Rate
- 1.4MHz Gain Bandwidth Product
- 120dB Minimum Voltage Gain, $V_S = \pm 15\text{V}$
- 0.8 μ V/ $^{\circ}\text{C}$ Maximum V_{OS} Drift
- 2.7V to $\pm 18\text{V}$ Supply Voltage Operation
- Operating Temperature Range: -40°C to 85°C
- Available in SO-8 and Space Saving 3mm \times 3mm DFN Packages

APPLICATIONS

- Thermocouple Amplifiers
- Precision Photodiode Amplifiers
- Instrumentation Amplifiers
- Battery-Powered Precision Systems
- Low-Voltage Precision Systems
- Micro-Power Sensor Interface

DESCRIPTION

The LT[®]6013 and LT6014 op amps combine low noise and high precision input performance with low power consumption and rail-to-rail output swing. The amplifiers are stable in a gain of 5 or more and feature greatly improved CMRR and PSRR versus frequency compared to other precision op amps.

Input offset voltage is factory-trimmed to less than 35 μ V. The low drift and excellent long-term stability ensure a high accuracy over temperature and time. The 250pA maximum input bias current and 120dB minimum voltage gain further maintain this precision over operating conditions.

The LT6013 and LT6014 operate from any supply voltage from 2.7V to 36V and draw only 145 μ A of supply current per amplifier on a 5V supply. The output swings to within 40mV of either supply rail, making the amplifiers very useful for low voltage single supply operation.

The amplifiers are fully specified at 5V and $\pm 15\text{V}$ supplies and from -40°C to 85°C . The single LT6013 and dual LT6014 are both available in SO-8 and space saving 3mm \times 3mm DFN packages. For unity gain stable versions, refer to the LT6010 and LT6011 data sheets.

LT, LTC and LT are registered trademarks of Linear Technology Corporation. All other trademarks are the property of their respective owners.

TYPICAL APPLICATION

Gain of 10 Single Ended to Differential Converter

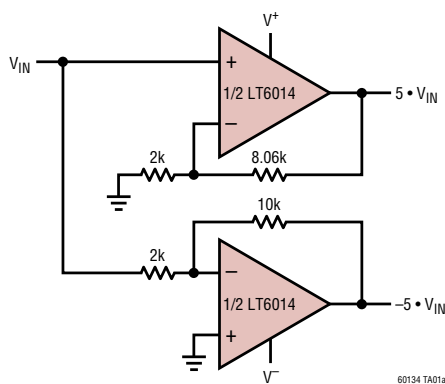

LT6013/LT6014 0.1Hz to 10Hz Voltage Noise

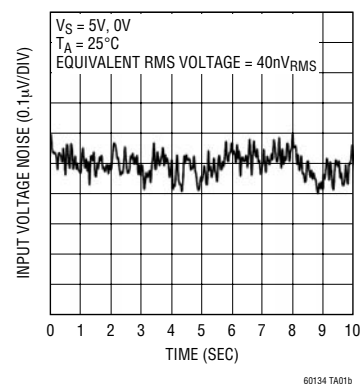

LT6013/LT6014

ABSOLUTE MAXIMUM RATINGS (Note 1)

Total Supply Voltage (V^+ to V^-)	40V	Maximum Junction Temperature	
Differential Input Voltage (Note 2)	10V	DD Package	125°C
Input Voltage	V^+ to V^-	S8 Package	150°C
Input Current (Note 2)	$\pm 10\text{mA}$	Storage Temperature Range	
Output Short-Circuit Duration (Note 3)	Indefinite	DD Package	-65°C to 125°C
Operating Temperature Range (Note 4) ..	-40°C to 85°C	S8 Package	-65°C to 150°C
Specified Temperature Range (Note 5) ...	-40°C to 85°C	Lead Temperature (Soldering, 10 sec)	300°C

PACKAGE/ORDER INFORMATION

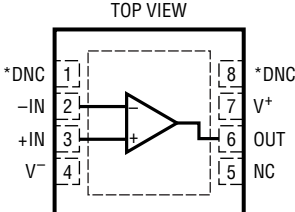
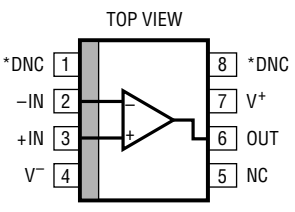
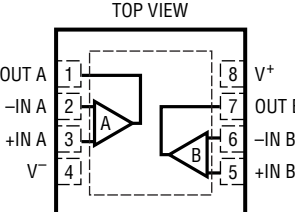
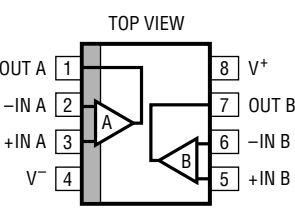
 <p>DD PACKAGE 8-LEAD (3mm x 3mm) PLASTIC DFN $T_{JMAX} = 125^\circ\text{C}$, $\theta_{JA} = 160^\circ\text{C/W}$ UNDERSIDE METAL CONNECTED TO V^- (PCB CONNECTION OPTIONAL)</p> <p>*Do Not Connect</p>	<p>ORDER PART NUMBER</p> <p>LT6013CDD LT6013IDD LT6013ACDD LT6013AIDD</p> <p>DD PART MARKING*</p> <p>LBHC</p>	 <p>S8 PACKAGE 8-LEAD PLASTIC SO $T_{JMAX} = 150^\circ\text{C}$, $\theta_{JA} = 190^\circ\text{C/W}$</p> <p>*Do Not Connect</p>	<p>ORDER PART NUMBER</p> <p>LT6013CS8 LT6013IS8 LT6013ACS8 LT6013AIS8</p> <p>S8 PART MARKING</p> <p>6013 6013I 6013A 6013AI</p>
 <p>DD PACKAGE 8-LEAD (3mm x 3mm) PLASTIC DFN $T_{JMAX} = 125^\circ\text{C}$, $\theta_{JA} = 160^\circ\text{C/W}$ UNDERSIDE METAL CONNECTED TO V^- (PCB CONNECTION OPTIONAL)</p>	<p>ORDER PART NUMBER</p> <p>LT6014CDD LT6014IDD LT6014ACDD LT6014AIDD</p> <p>DD PART MARKING*</p> <p>LBCB</p>	 <p>S8 PACKAGE 8-LEAD PLASTIC SO $T_{JMAX} = 150^\circ\text{C}$, $\theta_{JA} = 190^\circ\text{C/W}$</p>	<p>ORDER PART NUMBER</p> <p>LT6014CS8 LT6014IS8 LT6014ACS8 LT6014AIS8</p> <p>S8 PART MARKING</p> <p>6014 6014I 6014A 6014AI</p>

*Temperature and electrical grades are identified by a label on the shipping container.
Consult LTC Marketing for parts specified with wider operating temperature ranges.

ELECTRICAL CHARACTERISTICS The ● denotes the specifications which apply over the full operating temperature range, otherwise specifications are at $T_A = 25^\circ\text{C}$. $V_S = 5\text{V}$, 0V ; $V_{CM} = 2.5\text{V}$; R_L to 0V ; unless otherwise specified. (Note 5)

SYMBOL	PARAMETER	CONDITIONS	MIN	TYP	MAX	UNITS
V_{OS}	Input Offset Voltage (Note 8)	LT6013AS8 $T_A = 0^\circ\text{C}$ to 70°C $T_A = -40^\circ\text{C}$ to 85°C	● ●	10	35 60 75	μV μV μV
		LT6013S8, LT6014AS8 $T_A = 0^\circ\text{C}$ to 70°C $T_A = -40^\circ\text{C}$ to 85°C	● ●	20	60 85 110	μV μV μV
		LT6013ADD $T_A = 0^\circ\text{C}$ to 70°C $T_A = -40^\circ\text{C}$ to 85°C	● ●	20	60 110 150	μV μV μV
		LT6014S8 $T_A = 0^\circ\text{C}$ to 70°C $T_A = -40^\circ\text{C}$ to 85°C	● ●	20	75 100 125	μV μV μV
		LT6013DD, LT6014ADD $T_A = 0^\circ\text{C}$ to 70°C $T_A = -40^\circ\text{C}$ to 85°C	● ●	30	85 135 170	μV μV μV
		LT6014DD $T_A = 0^\circ\text{C}$ to 70°C $T_A = -40^\circ\text{C}$ to 85°C	● ●	30	125 175 210	μV μV μV
		$\Delta V_{OS}/\Delta T$	Input Offset Voltage Drift (Note 6)	S8 Packages	●	0.2
DD Packages	●			0.2	1.4	$\mu\text{V}/^\circ\text{C}$
I_{OS}	Input Offset Current (Note 8)	LT6013AS8, LT6013ADD $T_A = 0^\circ\text{C}$ to 70°C $T_A = -40^\circ\text{C}$ to 85°C	● ●	100	250 500 600	pA pA pA
		LT6014AS8, LT6014ADD $T_A = 0^\circ\text{C}$ to 70°C $T_A = -40^\circ\text{C}$ to 85°C	● ●	100	500 600 700	pA pA pA
		LT6013/LT6014 (Standard grades) $T_A = 0^\circ\text{C}$ to 70°C $T_A = -40^\circ\text{C}$ to 85°C	● ●	150	800 1000 1200	pA pA pA
I_B	Input Bias Current (Note 8)	LT6013AS8, LT6013ADD $T_A = 0^\circ\text{C}$ to 70°C $T_A = -40^\circ\text{C}$ to 85°C	● ●	100	± 250 ± 500 ± 600	pA pA pA
		LT6013S8, LT6013DD, LT6014AS8, LT6014ADD $T_A = 0^\circ\text{C}$ to 70°C $T_A = -40^\circ\text{C}$ to 85°C	● ●	100	± 400 ± 600 ± 800	pA pA pA
		LT6014S8, LT6014DD $T_A = 0^\circ\text{C}$ to 70°C $T_A = -40^\circ\text{C}$ to 85°C	● ●	150	± 800 ± 1000 ± 1200	pA pA pA
e_n	Input Noise Voltage Density	$f = 1\text{kHz}$, LT6013/LT6014		9.5		$\text{nV}/\sqrt{\text{Hz}}$
		$f = 1\text{kHz}$, LT6013A/LT6014A		9.5	13	$\text{nV}/\sqrt{\text{Hz}}$
	Input Noise Voltage (Low Frequency)	Bandwidth = 0.01Hz to 1Hz		200		nV_{P-P}
				50		nV_{RMS}
		Bandwidth = 0.1Hz to 10Hz		200		nV_{P-P}
				40		nV_{RMS}

ELECTRICAL CHARACTERISTICS

The ● denotes the specifications which apply over the full operating temperature range, otherwise specifications are at $T_A = 25^\circ\text{C}$. $V_S = 5\text{V}$, 0V ; $V_{\text{CM}} = 2.5\text{V}$; R_L to 0V ; unless otherwise specified. (Note 5)

SYMBOL	PARAMETER	CONDITIONS	MIN	TYP	MAX	UNITS
i_n	Input Noise Current Density	$f = 1\text{kHz}$		0.15		$\text{pA}/\sqrt{\text{Hz}}$
	Input Noise Current (Low Frequency)	Bandwidth = 0.01Hz to 1Hz		7 1.3		$\text{pA}_{\text{P-P}}$ pA_{RMS}
		Bandwidth = 0.1Hz to 10Hz		5 0.4		$\text{pA}_{\text{P-P}}$ pA_{RMS}
R_{IN}	Input Resistance	Common Mode, $V_{\text{CM}} = 1\text{V}$ to 3.8V		120		$\text{G}\Omega$
		Differential		20		$\text{M}\Omega$
C_{IN}	Input Capacitance			4		pF
V_{CM}	Input Voltage Range (Positive)	Guaranteed by CMRR	● 3.8	4		V
	Input Voltage Range (Negative)	Guaranteed by CMRR	●	0.7	1	V
CMRR	Common Mode Rejection Ratio	$V_{\text{CM}} = 1\text{V}$ to 3.8V	● 107	135		dB
	Minimum Supply Voltage	Guaranteed by PSRR	●	2.4	2.7	V
PSRR	Power Supply Rejection Ratio	$V_S = 2.7\text{V}$ to 36V , $V_{\text{CM}} = 1/2V_S$	● 112	135		dB
A_{VOL}	Large-Signal Voltage Gain	$R_L = 10\text{k}$, $V_{\text{OUT}} = 1\text{V}$ to 4V	● 300	2000		V/mV
		$R_L = 2\text{k}$, $V_{\text{OUT}} = 1\text{V}$ to 4V	● 250	2000		V/mV
	Channel Separation	$V_{\text{OUT}} = 1\text{V}$ to 4V , LT6014	● 110	140		dB
V_{OUT}	Maximum Output Swing (Positive, Referred to V^+)	No Load, 50mV Overdrive	●	35	55 65	mV mV
		$I_{\text{SOURCE}} = 1\text{mA}$, 50mV Overdrive	●	120	170 220	mV mV
	Maximum Output Swing (Negative, Referred to 0V)	No Load, 50mV Overdrive	●	40	55 65	mV mV
		$I_{\text{SINK}} = 1\text{mA}$, 50mV Overdrive	●	150	225 275	mV mV
I_{SC}	Output Short-Circuit Current (Note 3)	$V_{\text{OUT}} = 0\text{V}$, 1V Overdrive, Source	●	8 4	14	mA mA
		$V_{\text{OUT}} = 5\text{V}$, -1V Overdrive, Sink	●	8 4	21	mA mA
			●			
SR	Slew Rate	$A_V = -10$, $R_F = 50\text{k}$, $R_G = 5\text{k}$	●	0.15	0.2	$\text{V}/\mu\text{s}$
		$T_A = 0^\circ\text{C}$ to 70°C	●	0.12		$\text{V}/\mu\text{s}$
		$T_A = -40^\circ\text{C}$ to 85°C	●	0.1		$\text{V}/\mu\text{s}$
GBW	Gain Bandwidth Product	$f = 10\text{kHz}$	●	1 0.9	1.4	MHz MHz
t_s	Settling Time	$A_V = -4$, 0.01%, $V_{\text{OUT}} = 1.5\text{V}$ to 3.5V		20		μs
t_r , t_f	Rise Time, Fall Time	$A_V = 5$, 10% to 90%, 0.1V Step		1		μs

ELECTRICAL CHARACTERISTICS

The ● denotes the specifications which apply over the full operating temperature range, otherwise specifications are at $T_A = 25^\circ\text{C}$. $V_S = 5\text{V}$, 0V ; $V_{CM} = 2.5\text{V}$; R_L to 0V ; unless otherwise specified. (Note 5)

SYMBOL	PARAMETER	CONDITIONS	MIN	TYP	MAX	UNITS		
ΔV_{OS}	Offset Voltage Match (Note 7)	LT6014AS8		50	120	μV		
		$T_A = 0^\circ\text{C}$ to 70°C	●		170	μV		
		$T_A = -40^\circ\text{C}$ to 85°C	●		220	μV		
		LT6014ADD		50	170	μV		
		$T_A = 0^\circ\text{C}$ to 70°C	●		270	μV		
		$T_A = -40^\circ\text{C}$ to 85°C	●		340	μV		
		LT6014S8		50	150	μV		
		$T_A = 0^\circ\text{C}$ to 70°C	●		200	μV		
$T_A = -40^\circ\text{C}$ to 85°C	●		250	μV				
ΔI_B	Input Bias Current Match (Note 7)	LT6014AS8, LT6014ADD		200	800	pA		
		$T_A = 0^\circ\text{C}$ to 70°C	●		1200	pA		
		$T_A = -40^\circ\text{C}$ to 85°C	●		1400	pA		
		LT6014S8, LT6014DD		300	1600	pA		
		$T_A = 0^\circ\text{C}$ to 70°C	●		2000	pA		
		$T_A = -40^\circ\text{C}$ to 85°C	●		2400	pA		
		ΔCMRR	Common Mode Rejection Ratio Match (Note 7)	LT6014	●	101	135	dB
		ΔPSRR	Power Supply Rejection Ratio Match (Note 7)	LT6014	●	106	135	dB
I_S	Supply Current	per Amplifier		145	165	μA		
		$T_A = 0^\circ\text{C}$ to 70°C	●		210	μA		
		$T_A = -40^\circ\text{C}$ to 85°C	●		230	μA		

The ● denotes the specifications which apply over the full operating temperature range, otherwise specifications are at $T_A = 25^\circ\text{C}$. $V_S = \pm 15\text{V}$, $V_{CM} = 0\text{V}$, R_L to 0V , unless otherwise specified. (Note 5)

SYMBOL	PARAMETER	CONDITIONS	MIN	TYP	MAX	UNITS
V_{OS}	Input Offset Voltage (Note 8)	LT6013AS8		20	60	μV
		$T_A = 0^\circ\text{C}$ to 70°C	●		80	μV
		$T_A = -40^\circ\text{C}$ to 85°C	●		110	μV
		LT6013S8		25	85	μV
		$T_A = 0^\circ\text{C}$ to 70°C	●		110	μV
		$T_A = -40^\circ\text{C}$ to 85°C	●		135	μV
		LT6013ADD		25	85	μV
		$T_A = 0^\circ\text{C}$ to 70°C	●		135	μV
		$T_A = -40^\circ\text{C}$ to 85°C	●		170	μV
		LT6013DD, LT6014AS8		30	135	μV
		$T_A = 0^\circ\text{C}$ to 70°C	●		160	μV
		$T_A = -40^\circ\text{C}$ to 85°C	●		185	μV
V_{OS}	Input Offset Voltage (Note 8)	LT6014S8		35	150	μV
		$T_A = 0^\circ\text{C}$ to 70°C	●		175	μV
		$T_A = -40^\circ\text{C}$ to 85°C	●		200	μV
		LT6014ADD		35	160	μV
		$T_A = 0^\circ\text{C}$ to 70°C	●		210	μV
		$T_A = -40^\circ\text{C}$ to 85°C	●		225	μV
		LT6014DD		40	200	μV
		$T_A = 0^\circ\text{C}$ to 70°C	●		250	μV
$T_A = -40^\circ\text{C}$ to 85°C	●		275	μV		

LT6013/LT6014

ELECTRICAL CHARACTERISTICS

The ● denotes the specifications which apply over the full operating temperature range, otherwise specifications are at $T_A = 25^\circ\text{C}$. $V_S = \pm 15\text{V}$, $V_{CM} = 0\text{V}$, R_L to 0V , unless otherwise specified. (Note 5)

SYMBOL	PARAMETER	CONDITIONS	MIN	TYP	MAX	UNITS
$\Delta V_{OS}/\Delta T$	Input Offset Voltage Drift (Note 6)	S8 Packages	●	0.2	0.8	$\mu\text{V}/^\circ\text{C}$
		DD Packages	●	0.2	1.2	$\mu\text{V}/^\circ\text{C}$
I_{OS}	Input Offset Current (Note 8)	LT6013AS8, LT6013ADD	●	100	250	pA
		$T_A = 0^\circ\text{C}$ to 70°C	●		500	pA
		$T_A = -40^\circ\text{C}$ to 85°C	●		600	pA
		LT6014AS8, LT6014ADD	●	100	500	pA
		$T_A = 0^\circ\text{C}$ to 70°C	●		600	pA
		$T_A = -40^\circ\text{C}$ to 85°C	●		700	pA
		LT6013/LT6014 (Standard grades)	●	150	800	pA
		$T_A = 0^\circ\text{C}$ to 70°C	●		1000	pA
		$T_A = -40^\circ\text{C}$ to 85°C	●		1200	pA
I_B	Input Bias Current (Note 8)	LT6013AS8, LT6013ADD	●	100	± 250	pA
		$T_A = 0^\circ\text{C}$ to 70°C	●		± 500	pA
		$T_A = -40^\circ\text{C}$ to 85°C	●		± 600	pA
		LT6013S8, LT6013DD, LT6014AS8, LT6014ADD	●	100	± 400	pA
		$T_A = 0^\circ\text{C}$ to 70°C	●		± 600	pA
		$T_A = -40^\circ\text{C}$ to 85°C	●		± 800	pA
		LT6014S8, LT6014DD	●	150	± 800	pA
		$T_A = 0^\circ\text{C}$ to 70°C	●		± 1000	pA
		$T_A = -40^\circ\text{C}$ to 85°C	●		± 1200	pA
e_n	Input Noise Voltage Density	$f = 1\text{kHz}$, LT6013/LT6014		9.5		$\text{nV}/\sqrt{\text{Hz}}$
		$f = 1\text{kHz}$, LT6013A/LT6014A		9.5	13	$\text{nV}/\sqrt{\text{Hz}}$
	Input Noise Voltage (Low Frequency)	Bandwidth = 0.01Hz to 1Hz		200		nV_{P-P}
				50		nV_{RMS}
		Bandwidth = 0.1Hz to 10Hz		200		nV_{P-P}
				40		nV_{RMS}
i_n	Input Noise Current Density	$f = 1\text{kHz}$		0.15		$\text{pA}/\sqrt{\text{Hz}}$
	Input Noise Current (Low Frequency)	Bandwidth = 0.01Hz to 1Hz		7		pA_{P-P}
				1.3		pA_{RMS}
		Bandwidth = 0.1Hz to 10Hz		5		pA_{P-P}
				0.4		pA_{RMS}
R_{IN}	Input Resistance	Common Mode, $V_{CM} = \pm 13.5\text{V}$		400		$\text{G}\Omega$
		Differential		20		$\text{M}\Omega$
C_{IN}	Input Capacitance			4		pF
V_{CM}	Input Voltage Range	Guaranteed by CMRR	●	± 13.5	± 14	V
CMRR	Common Mode Rejection Ratio	$V_{CM} = -13.5\text{V}$ to 13.5V	●	115	135	dB
			●	112	135	dB
	Minimum Supply Voltage	Guaranteed by PSRR	●	± 1.2	± 1.35	V
PSRR	Power Supply Rejection Ratio	$V_S = \pm 1.35\text{V}$ to $\pm 18\text{V}$	●	112	135	dB
A_{VOL}	Large-Signal Voltage Gain	$R_L = 10\text{k}$, $V_{OUT} = -13.5\text{V}$ to 13.5V	●	1000	2000	V/mV
			●	600		V/mV
		$R_L = 5\text{k}$, $V_{OUT} = -13.5\text{V}$ to 13.5V	●	500	1500	V/mV
			●	300		V/mV
	Channel Separation	$V_{OUT} = -13.5\text{V}$ to 13.5V , LT6014	●	120	140	dB

ELECTRICAL CHARACTERISTICS The ● denotes the specifications which apply over the full operating temperature range, otherwise specifications are at $T_A = 25^\circ\text{C}$. $V_S = \pm 15\text{V}$, $V_{CM} = 0\text{V}$, R_L to 0V , unless otherwise specified. (Note 5)

SYMBOL	PARAMETER	CONDITIONS	MIN	TYP	MAX	UNITS				
V_{OUT}	Maximum Output Swing (Positive, Referred to V^+)	No Load, 50mV Overdrive	●	45	80 100	mV mV				
		$I_{SOURCE} = 1\text{mA}$, 50mV Overdrive	●	140	195 240	mV mV				
	Maximum Output Swing (Negative, Referred to V^-)	No Load, 50mV Overdrive	●	45	80 100	mV mV				
		$I_{SINK} = 1\text{mA}$, 50mV Overdrive	●	150	250 300	mV mV				
I_{SC}	Output Short-Circuit Current (Note 3)	$V_{OUT} = 0\text{V}$, 1V Overdrive (Source)	●	8 5	15	mA mA				
		$V_{OUT} = 0\text{V}$, -1V Overdrive (Sink)	●	8 5	20	mA mA				
SR	Slew Rate	$A_V = -10$, $R_F = 50\text{k}$, $R_G = 5\text{k}$ $T_A = 0^\circ\text{C}$ to 70°C $T_A = -40^\circ\text{C}$ to 85°C	● ● ●	0.15 0.12 0.1	0.2	V/ μs V/ μs V/ μs				
GBW	Gain Bandwidth Product	$f = 10\text{kHz}$	●	1.1 1	1.6	MHz MHz				
t_s	Settling Time	$A_V = -4$, 0.01%, $V_{OUT} = 0\text{V}$ to 10V		40		μs				
t_r , t_f	Rise Time, Fall Time	$A_V = 5$, 10% to 90%, 0.1V Step		0.9		μs				
ΔV_{OS}	Offset Voltage Match (Note 7)	LT6014AS8 $T_A = 0^\circ\text{C}$ to 70°C $T_A = -40^\circ\text{C}$ to 85°C	● ●	50	270 320 370	μV μV μV				
		LT6014ADD $T_A = 0^\circ\text{C}$ to 70°C $T_A = -40^\circ\text{C}$ to 85°C	● ●	50	320 420 450	μV μV μV				
		LT6014S8 $T_A = 0^\circ\text{C}$ to 70°C $T_A = -40^\circ\text{C}$ to 85°C	● ●	70	300 350 400	μV μV μV				
		LT6014DD $T_A = 0^\circ\text{C}$ to 70°C $T_A = -40^\circ\text{C}$ to 85°C	● ●	80	400 500 550	μV μV μV				
		ΔI_B	Input Bias Current Match (Note 7)	LT6014AS8, LT6014ADD $T_A = 0^\circ\text{C}$ to 70°C $T_A = -40^\circ\text{C}$ to 85°C	● ●	200	800 1200 1400	pA pA pA		
				LT6014S8, LT6014DD $T_A = 0^\circ\text{C}$ to 70°C $T_A = -40^\circ\text{C}$ to 85°C	● ●	300	1600 2000 2400	pA pA pA		
				ΔCMRR	Common Mode Rejection Ratio Match (Note 7)	LT6014	●	109	135	dB
				ΔPSRR	Power Supply Rejection Ratio Match (Note 7)	LT6014	●	106	135	dB
I_S	Supply Current	per Amplifier $T_A = 0^\circ\text{C}$ to 70°C $T_A = -40^\circ\text{C}$ to 85°C	● ●	200	250 290 310	μA μA μA				

ELECTRICAL CHARACTERISTICS

Note 1: Absolute Maximum Ratings are those beyond which the life of the device may be impaired.

Note 2: The inputs are protected by back-to-back diodes and internal series resistors. If the differential input voltage exceeds 10V, the input current must be limited to less than 10mA.

Note 3: A heat sink may be required to keep the junction temperature below absolute maximum ratings.

Note 4: The LT6013C/LT6014C and LT6013I/LT6014I are guaranteed functional over the operating temperature range of -40°C to 85°C .

Note 5: The LT6013C and LT6014C are guaranteed to meet the specified performance from 0°C to 70°C and are designed, characterized and expected to meet specified performance from -40°C to 85°C but is not tested or QA sampled at these temperatures. The LT6013I and LT6014I are guaranteed to meet specified performance from -40°C to 85°C .

Note 6: This parameter is not 100% tested.

Note 7: Matching parameters are the difference between the two amplifiers. ΔCMRR and ΔPSRR are defined as follows: (1) CMRR and PSRR are measured in $\mu\text{V}/\text{V}$ for the individual amplifiers. (2) The difference between matching amplifiers is calculated in $\mu\text{V}/\text{V}$. (3) The result is converted to dB.

Note 8: The specifications for V_{OS} , I_B , and I_{OS} depend on the grade and on the package. The following table clarifies the notations.

	STANDARD GRADE	A GRADE
S8 Package	LT6013S8, LT6014S8	LT6013AS8, LT6014AS8
DFN Package	LT6013DD, LT6014DD	LT6013ADD, LT6014ADD

TYPICAL PERFORMANCE CHARACTERISTICS

Distribution of Input Offset Voltage

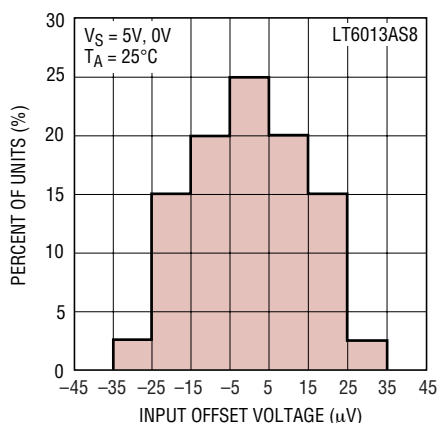

60134 G01

Input Offset Voltage vs Temperature

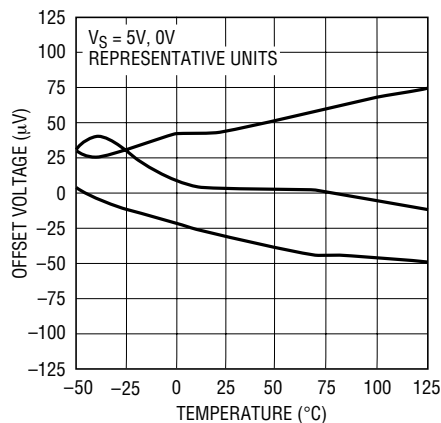

60134 G02

Offset Voltage vs Input Common Mode Voltage

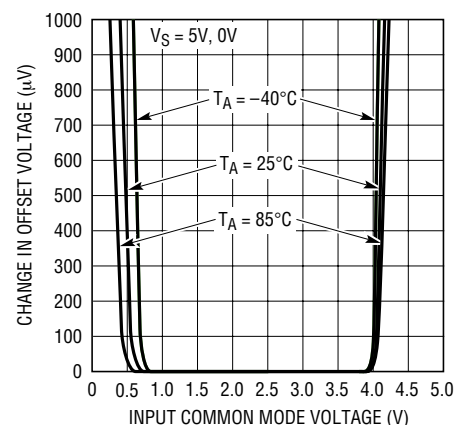

60134 G03

Distribution of Input Bias Current

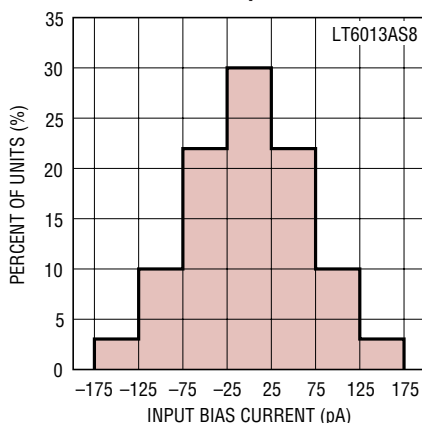

60134 G04

Input Bias Current vs Temperature

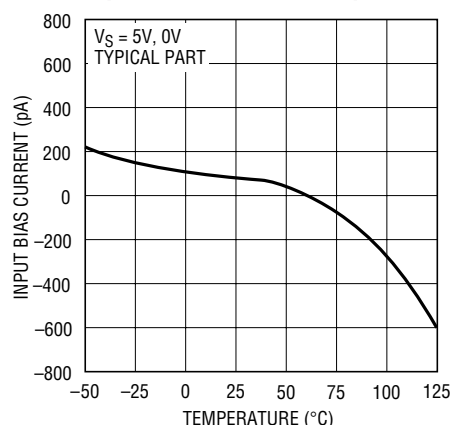

60134 G05

Input Bias Current vs Input Common Mode Voltage

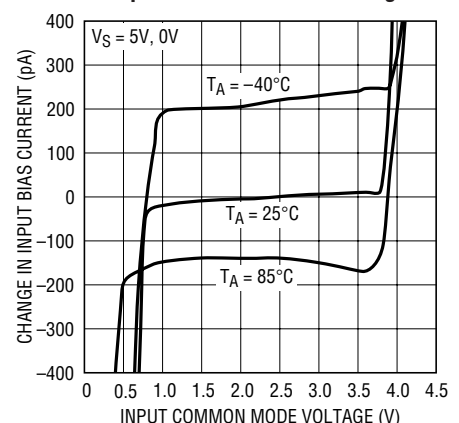

60134 G06

60134fb

TYPICAL PERFORMANCE CHARACTERISTICS

e_n, i_n vs Frequency

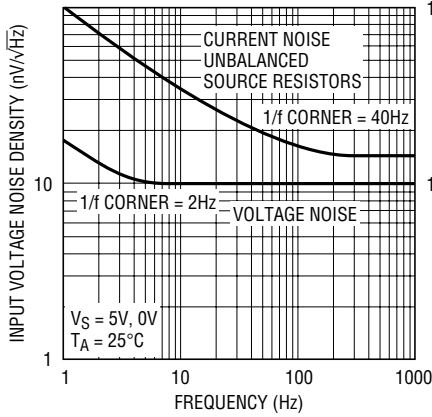

60134 G07

Total Input Noise vs Source Resistance

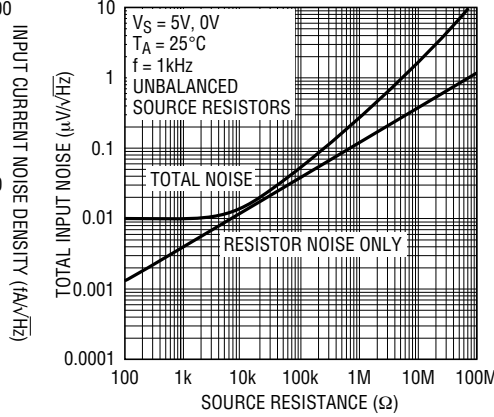

60134 G08

0.1Hz to 10Hz Voltage Noise



60134 G09

0.01Hz to 1Hz Voltage Noise



60134 G10

0.1Hz to 10Hz Current Noise

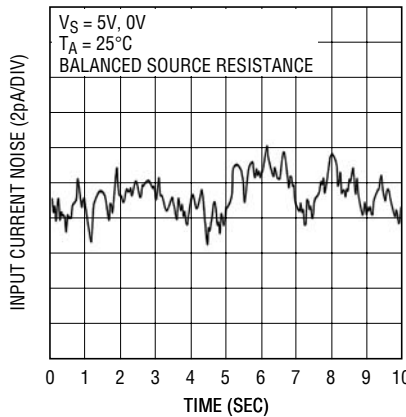

60134 G31

0.01Hz to 1Hz Current Noise

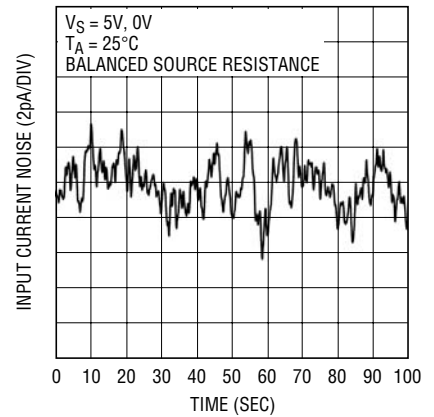

60134 G32

Output Voltage Swing vs Temperature

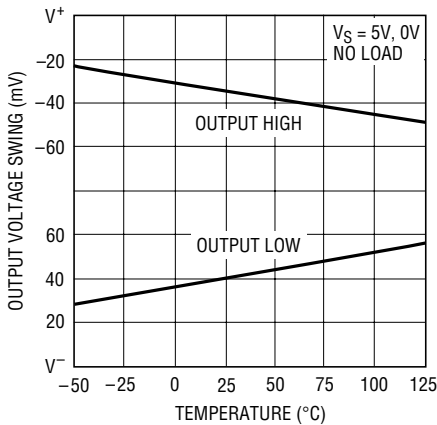

60134 G11

Output Saturation Voltage vs Load Current (Output High)

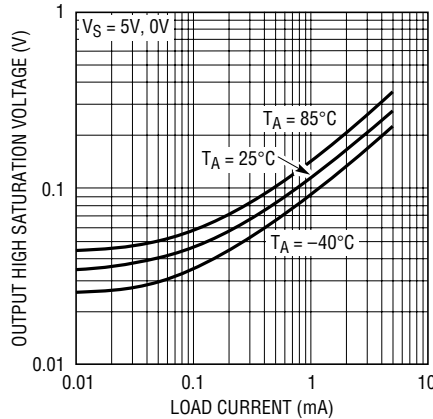

60134 G12

Output Saturation Voltage vs Load Current (Output Low)

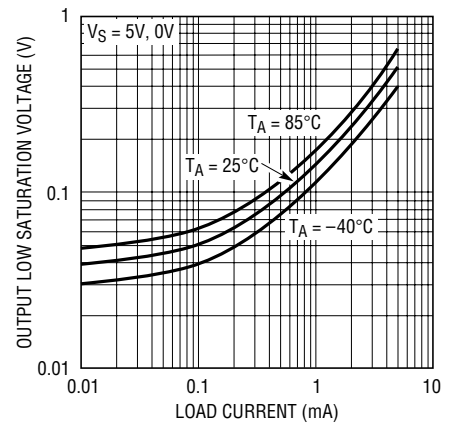

60134 G13

TYPICAL PERFORMANCE CHARACTERISTICS

Supply Current vs Supply Voltage

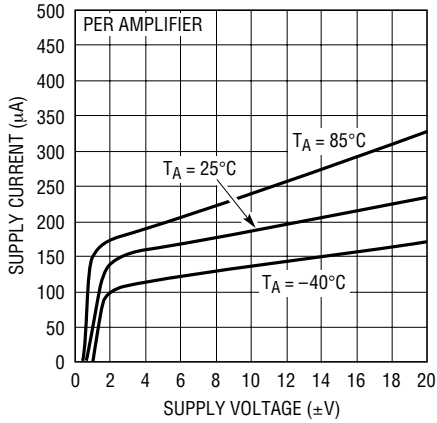

60134 G14

Warm-Up Drift

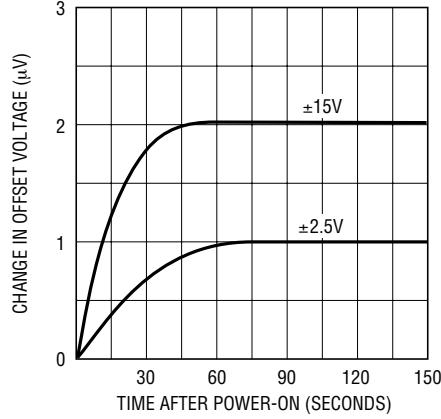

60134 G15

THD + Noise vs Frequency

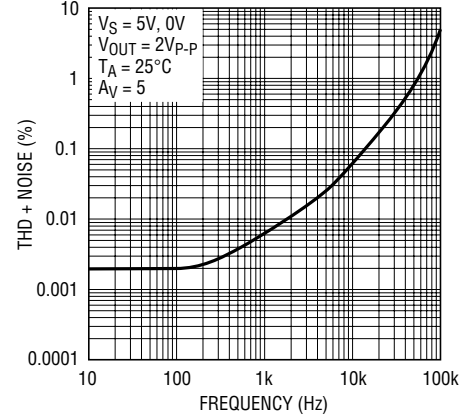

60134 G16

THD + Noise vs Frequency

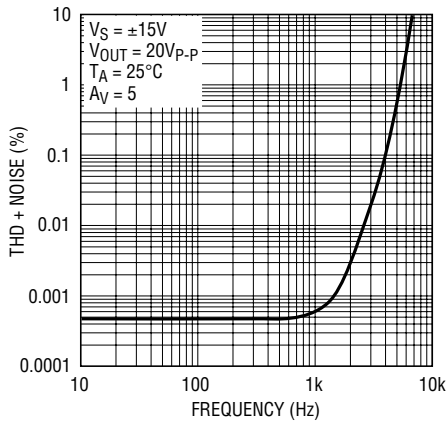

60134 G17

Settling Time vs Output Step

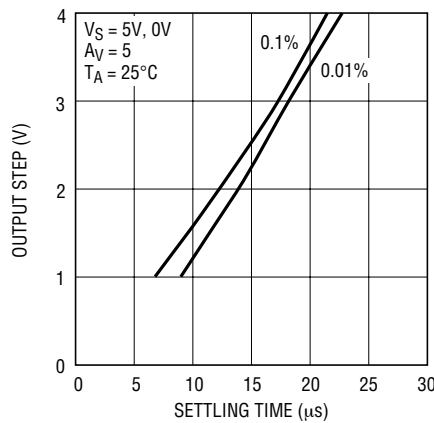

60134 G18

Channel Separation vs Frequency

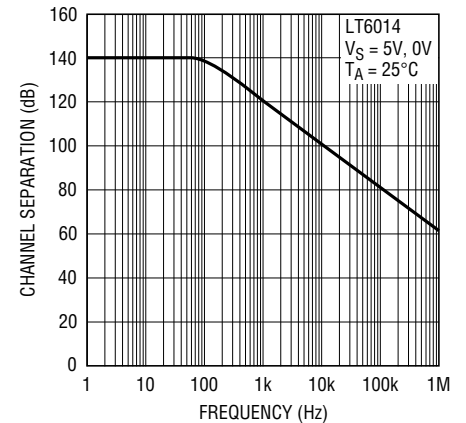

60134 G20

CMRR vs Frequency

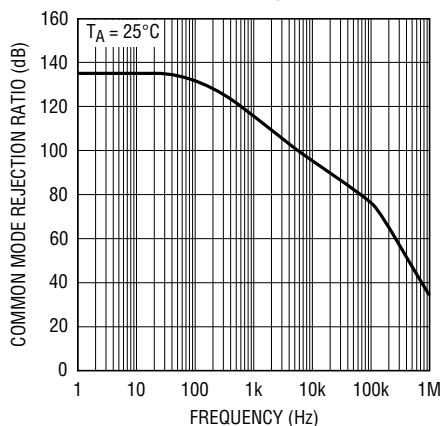

60134 G21

PSRR vs Frequency, Single Supply

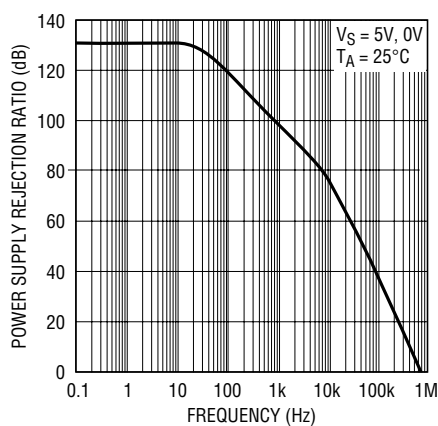

60134 G19

PSRR vs Frequency, Split Supplies

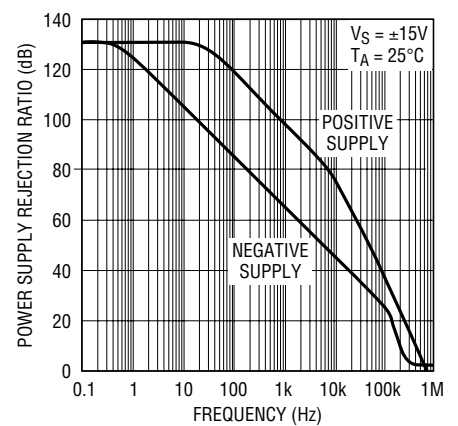

60134 G22

TYPICAL PERFORMANCE CHARACTERISTICS

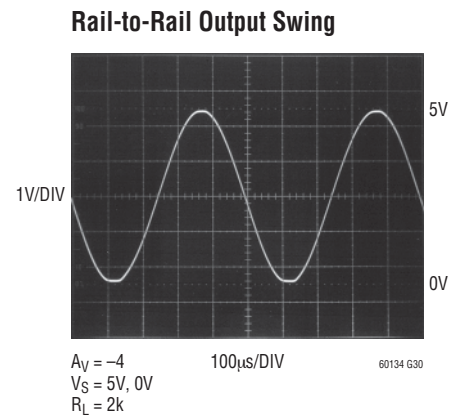
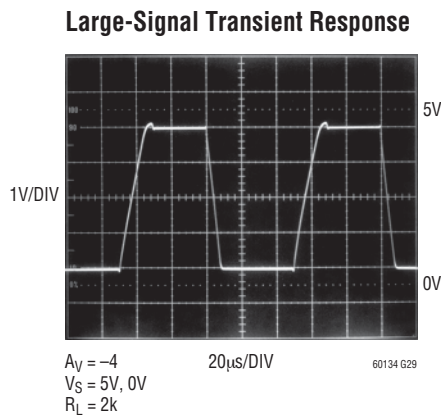
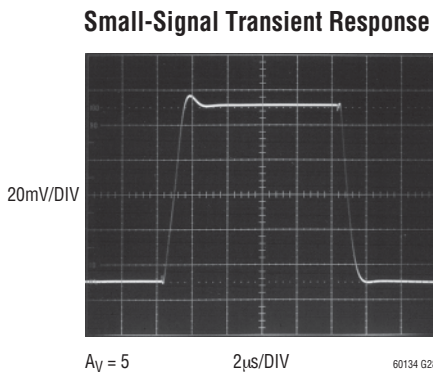
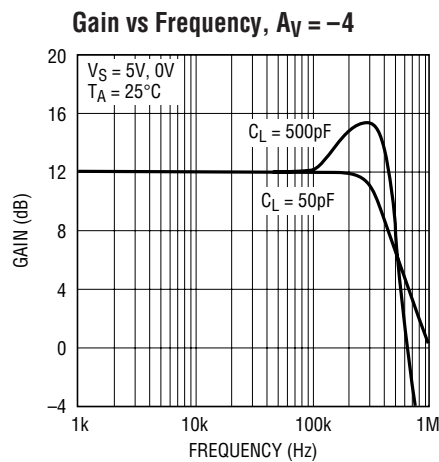
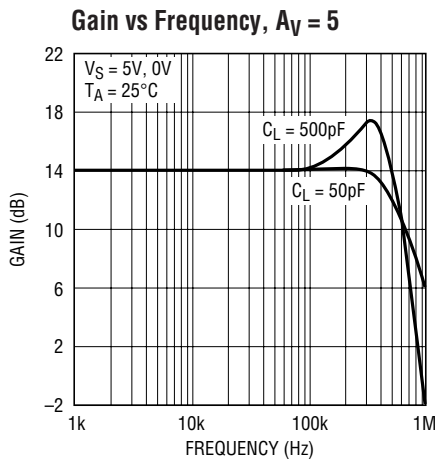
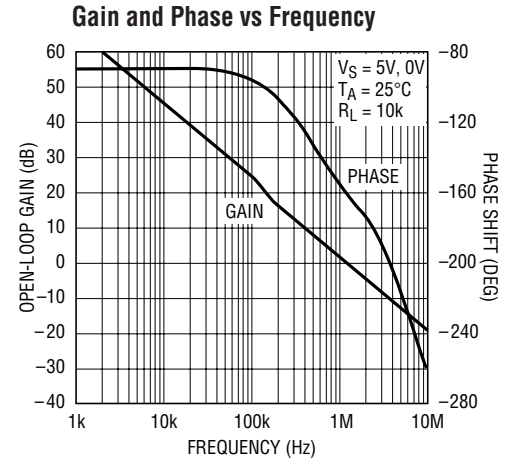
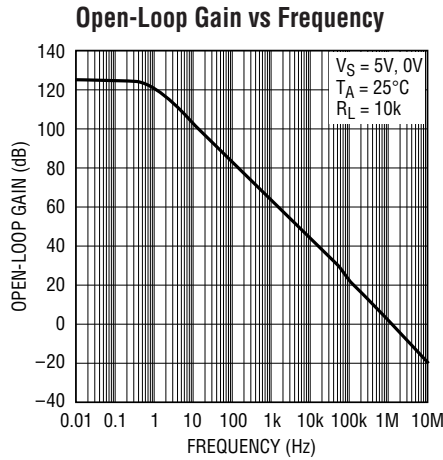
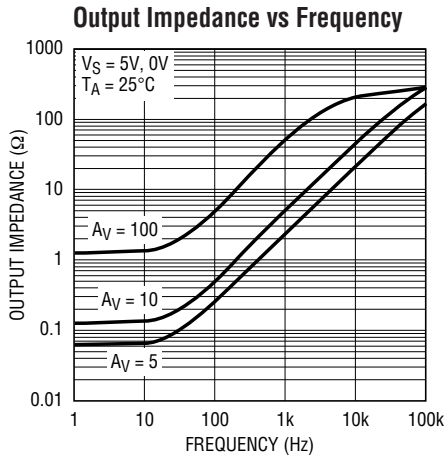

APPLICATIONS INFORMATION

Not Unity-Gain Stable

The LT6013 and LT6014 amplifiers are optimized for the lowest possible noise and smallest package size, and are intentionally decompensated to be stable in a gain configuration of 5 or greater. Do not connect the amplifiers in a gain less than 5 (such as unity-gain). For a unity-gain stable amplifier with similar performance though slightly higher noise and lower bandwidth, see the LT6010 and LT6011/LT6012 datasheets.

Figure 1 shows simple inverting and non-inverting op amp configurations and indicates how to achieve a gain of 5 or greater. For more general feedback networks, determine the gain that the op amp “sees” as follows:

1. Suppose the op amp is removed from the circuit.
2. Apply a small-signal voltage at the output node of the op amp.

3. Find the differential voltage that would appear across the two inputs of the op amp.
4. The ratio of the output voltage to the input voltage is the gain that the op amp “sees”. This ratio must be 5 or greater.

Do not place a capacitor bigger than 200pF between the output to the inverting input unless there is a 5 times larger capacitor from that input to AC ground. Otherwise, the op amp gain would drop to less than 5 at high frequencies, and the stability of the loop would be compromised.

The LT6013 and LT6014 can be used in lower gain configurations when an impedance is connected between the op amp inputs. Figure 2 shows inverting and non-inverting unity gain connections. The R_C network across the op amp inputs results in a large enough noise gain at high frequencies, thereby ensuring stability. At low frequencies, the capacitor is an open circuit so the DC precision (offset and noise) remains very good.

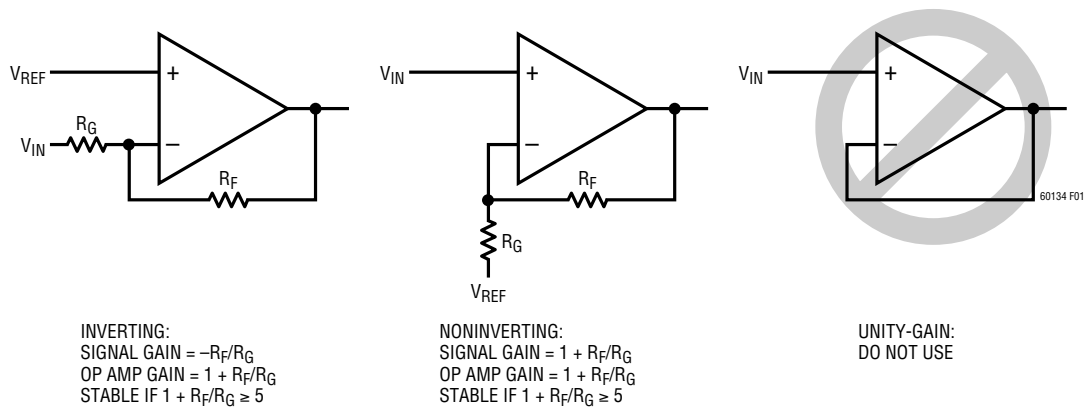

Figure 1. Use LT6013 and LT6014 in a Gain of 5 or Greater

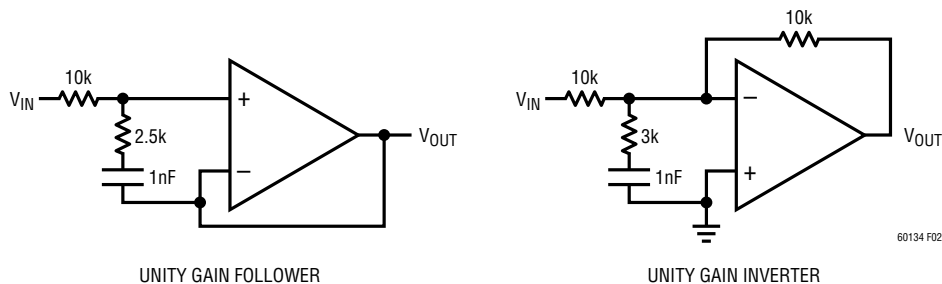

Figure 2. Stabilizing Op Amp for Unity Gain Operation

APPLICATIONS INFORMATION

Preserving Input Precision

Preserving the input accuracy of the LT6013 and LT6014 requires that the applications circuit and PC board layout do not introduce errors comparable to or greater than the $10\mu\text{V}$ typical offset of the amplifiers. Temperature differentials across the input connections can generate thermocouple voltages of 10's of microvolts so the connections to the input leads should be short, close together and away from heat dissipating components. Air currents across the board can also generate temperature differentials.

The extremely low input bias currents allow high accuracy to be maintained with high impedance sources and feedback resistors. The LT6013 and LT6014 low input bias currents are obtained by a cancellation circuit on-chip. This causes the resulting I_{B^+} and I_{B^-} to be uncorrelated, as implied by the I_{OS} specification being comparable to I_B . Do not try to balance the input resistances in each input lead; instead keep the resistance at either input as low as possible for maximum accuracy.

Leakage currents on the PC board can be higher than the input bias current. For example, $10\text{G}\Omega$ of leakage between a 15V supply lead and an input lead will generate 1.5nA! Surround the input leads with a guard ring driven to the same potential as the input common mode to avoid excessive leakage in high impedance applications.

Input Protection

The LT6013/LT6014 features on-chip back-to-back diodes between the input devices, along with 500Ω resistors in series with either input. This internal protection limits the input current to approximately 10mA (the maximum allowed) for a 10V differential input voltage. Use additional external series resistors to limit the input current to 10mA in applications where differential inputs of more than 10V

are expected. For example, a 1k resistor in series with each input provides protection against 30V differential voltage.

Input Common Mode Range

The LT6013/LT6014 output is able to swing close to each power supply rail (rail-to-rail out), but the input stage is limited to operating between $V^- + 1\text{V}$ and $V^+ - 1.2\text{V}$. Exceeding this common mode range will cause the gain to drop to zero; however, no phase reversal will occur.

Total Input Noise

The LT6013 and LT6014 amplifiers contribute negligible noise to the system when driven by sensors (sources) with impedance between $10\text{k}\Omega$ and $1\text{M}\Omega$. Throughout this range, total input noise is dominated by the $4kTR_S$ noise of the source. If the source impedance is less than $10\text{k}\Omega$, the input voltage noise of the amplifier starts to contribute with a minimum noise of $9.5\text{nV}/\sqrt{\text{Hz}}$ for very low source impedance. If the source impedance is more than $1\text{M}\Omega$, the input current noise of the amplifier, multiplied by this high impedance, starts to contribute and eventually dominate. Total input noise spectral density can be calculated as:

$$v_{n(\text{TOTAL})} = \sqrt{e_n^2 + 4kTR_S + (i_n R_S)^2}$$

where $e_n = 9.5\text{nV}/\sqrt{\text{Hz}}$, $i_n = 0.15\text{pA}/\sqrt{\text{Hz}}$ and R_S is the total impedance at the input, including the source impedance.

Capacitive Loads

The LT6013 and LT6014 can drive capacitive loads up to 500pF at a gain of 5. The capacitive load driving capability increases as the amplifier is used in higher gain configurations. A small series resistance between the output and the load further increases the amount of capacitance that the amplifier can drive.

SIMPLIFIED SCHEMATIC (One Amplifier)

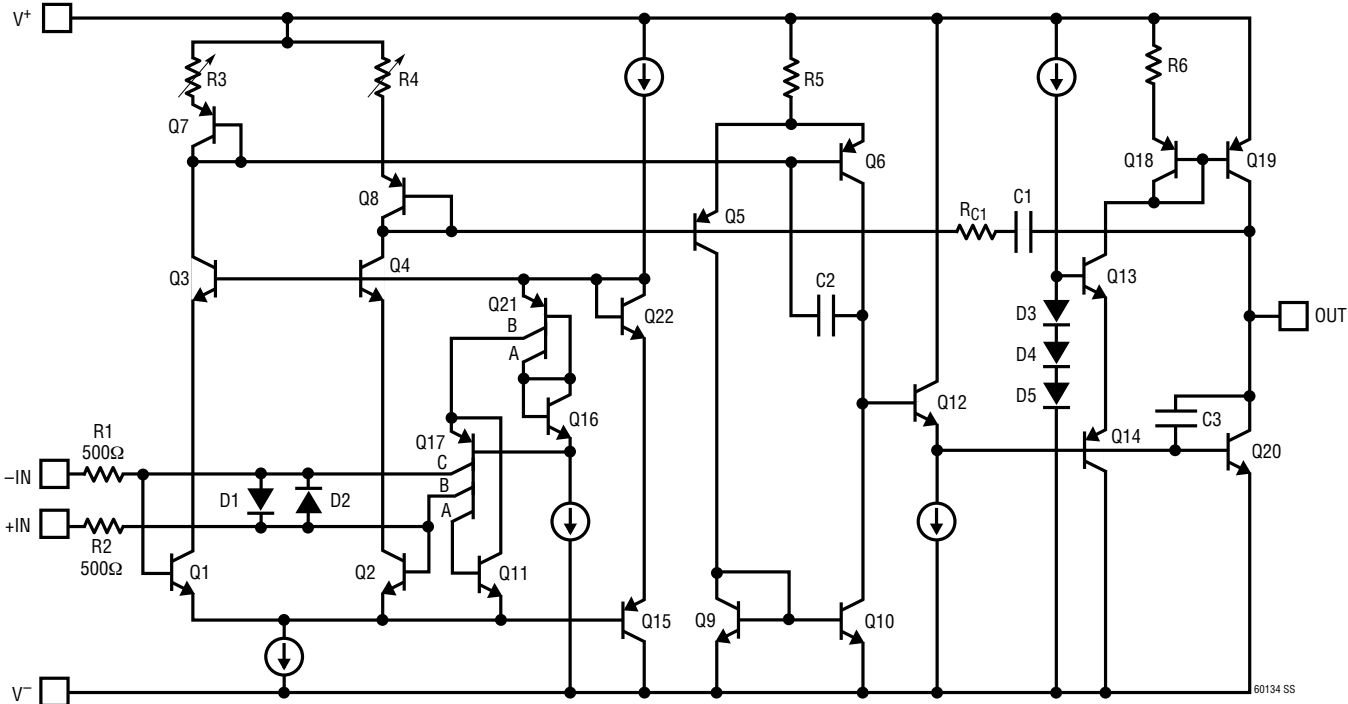

PACKAGE DESCRIPTION

DD Package 8-Lead Plastic DFN (3mm × 3mm) (Reference LTC DWG # 05-08-1698)

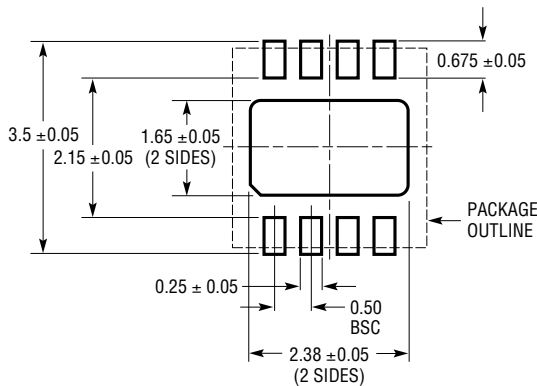

RECOMMENDED SOLDER PAD PITCH AND DIMENSIONS

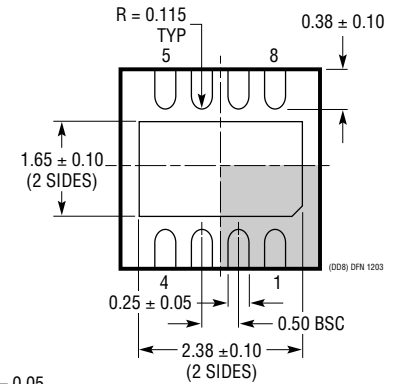
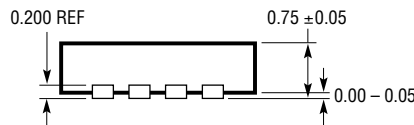
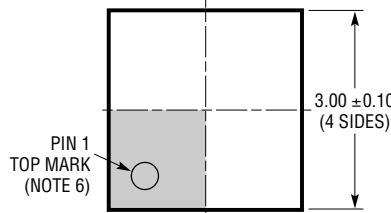

BOTTOM VIEW—EXPOSED PAD

NOTE:

1. DRAWING TO BE MADE A JEDEC PACKAGE OUTLINE M0-229 VARIATION OF (WEED-1)
2. DRAWING NOT TO SCALE
3. ALL DIMENSIONS ARE IN MILLIMETERS
4. DIMENSIONS OF EXPOSED PAD ON BOTTOM OF PACKAGE DO NOT INCLUDE MOLD FLASH. MOLD FLASH, IF PRESENT, SHALL NOT EXCEED 0.15mm ON ANY SIDE
5. EXPOSED PAD SHALL BE SOLDER PLATED
6. SHADED AREA IS ONLY A REFERENCE FOR PIN 1 LOCATION ON TOP AND BOTTOM OF PACKAGE

S8 Package 8-Lead Plastic Small Outline (Narrow .150 Inch) (Reference LTC DWG # 05-08-1610)

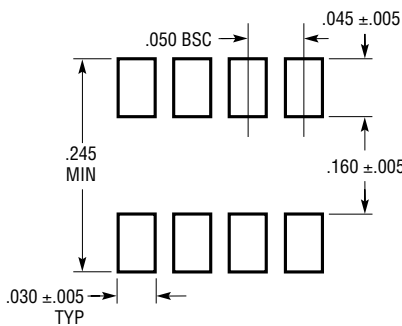

RECOMMENDED SOLDER PAD LAYOUT

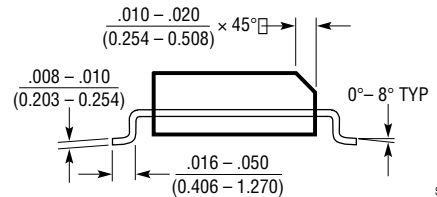
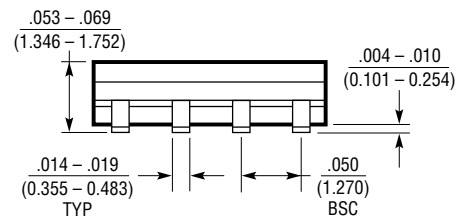
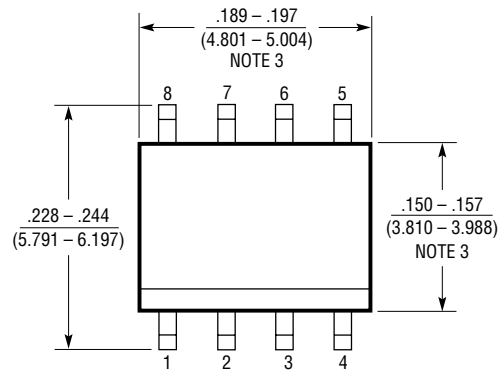

S08 0303

NOTE:

1. DIMENSIONS IN $\frac{\text{INCHES}}{\text{MILLIMETERS}}$
2. DRAWING NOT TO SCALE
3. THESE DIMENSIONS DO NOT INCLUDE MOLD FLASH OR PROTRUSIONS. MOLD FLASH OR PROTRUSIONS SHALL NOT EXCEED .006" (0.15mm)

TYPICAL APPLICATION

Low Power Hall Sensor Amplifier

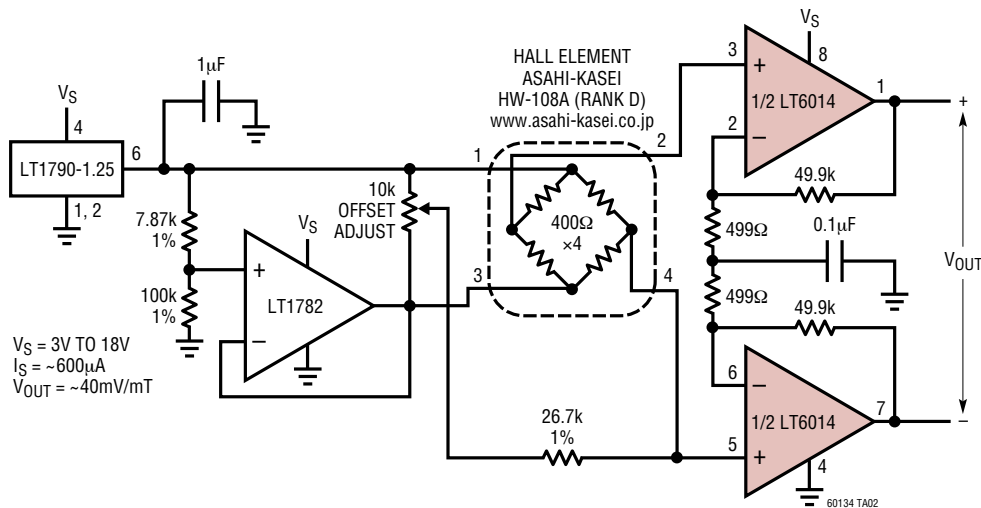

Precision Micropower Photodiode Amplifier

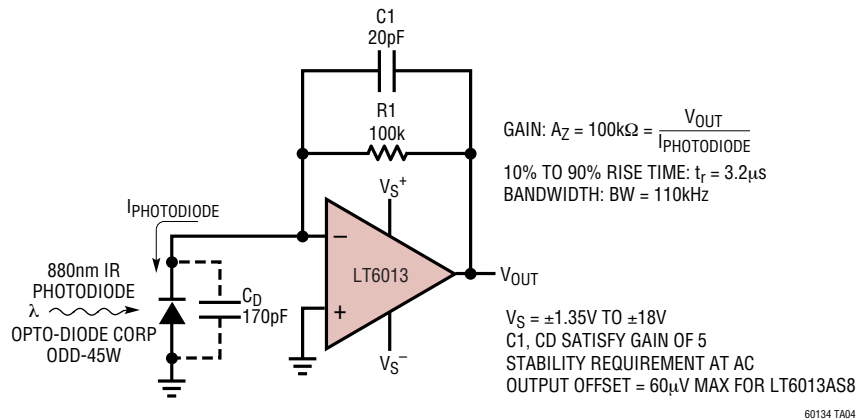

RELATED PARTS

PART NUMBER	DESCRIPTION	COMMENTS
LT1112/LT1114	Dual/Quad Low Power, Picoamp Input Precision Op Amps	250pA Input Bias Current
LT1880	Rail-to-Rail Output, Picoamp Input Precision Op Amp	SOT-23
LT1881/LT1882	Dual/Quad Rail-to-Rail Output, Picoamp Input Precision Op Amps	C_{LOAD} Up to 1000pF
LT1884/LT1885	Dual/Quad Rail-to-Rail Output, Picoamp Input Precision Op Amps	9.5nV/ \sqrt{Hz} Input Noise
LT6011/LT6012	Dual/Quad Low Power Rail-to-Rail Output, Precision Op Amps	14nV/ \sqrt{Hz} , Unity-Gain Stable Version of LT6014
LT6010	Single Low Power Rail-to-Rail Output, Precision Op Amp	200pA Input Bias Current, Shutdown Feature

Mouser Electronics

Authorized Distributor

Click to View Pricing, Inventory, Delivery & Lifecycle Information:

Analog Devices Inc.:

[LT6014CDD](#) [LT6013AIS8#TRPBF](#) [LT6013IDD#PBF](#) [LT6014ACDD#TRPBF](#) [LT6013AIDD](#) [LT6013IS8](#)
[LT6014AIS8#PBF](#) [LT6014ACS8#TR](#) [LT6013IS8#TRPBF](#) [LT6014CDD#TRPBF](#) [LT6014IDD#TR](#)
[LT6013AIDD#TRPBF](#) [LT6013ACS8#TR](#) [LT6014ACS8#TRPBF](#) [LT6014IS8#PBF](#) [LT6013AIDD#PBF](#)
[LT6014CDD#PBF](#) [LT6013CDD#TRPBF](#) [LT6014IDD#TRPBF](#) [LT6014IS8#TR](#) [LT6014CS8](#) [LT6014ACDD](#)
[LT6014CS8#TRPBF](#) [LT6014ACDD#PBF](#) [LT6013AIDD#TR](#) [LT6013AIS8](#) [LT6014CS8#PBF](#) [LT6014AIDD](#)
[LT6014IS8#TRPBF](#) [LT6013ACDD#TRPBF](#) [LT6013CS8](#) [LT6013CS8#TR](#) [LT6014AIDD#TRPBF](#) [LT6014IDD](#)
[LT6014AIS8#TR](#) [LT6013CDD](#) [LT6013CS8#TRPBF](#) [LT6013AIS8#PBF](#) [LT6013IS8#TR](#) [LT6013ACDD#PBF](#)
[LT6014ACDD#TR](#) [LT6014CS8#TR](#) [LT6013IDD](#) [LT6013IDD#TRPBF](#) [LT6013ACDD](#) [LT6014ACS8#PBF](#)
[LT6014AIS8#TRPBF](#) [LT6014IS8](#) [LT6014IDD#PBF](#) [LT6013AIS8#TR](#) [LT6013CDD#PBF](#) [LT6014AIDD#PBF](#)
[LT6014ACS8](#) [LT6014AIS8](#) [LT6013ACS8](#) [LT6013ACS8#PBF](#) [LT6013ACS8#TRPBF](#) [LT6013CS8#PBF](#)
[LT6013CDD#TR](#) [LT6013IS8#PBF](#) [LT6014AIDD#TR](#) [LT6013ACDD#TR](#) [LT6013IDD#TR](#) [LT6014CDD#TR](#)