

60 V power Schottky rectifier

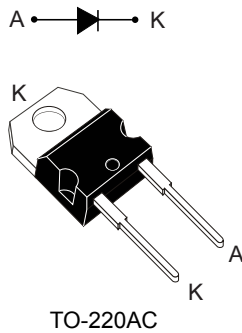

Features

- Low forward voltage drop
- Negligible switching losses
- Low thermal resistance
- Avalanche capability specified
- ECOPACK[®]2 compliant

Applications

- Switching diode
- SMPS
- DC/DC converter
- Lighting

Description

This Schottky rectifier is designed for switched mode power supplies (SMPS) and high frequency DC to DC converters.

Packaged in TO-220AC, the **STPS10L60** is optimized for use in DC/DC converters.

Product status link	
STPS10L60	
Product summary	
Symbol	Value
$I_{F(AV)}$	10 A
V_{RRM}	60 V
T_j (max.)	150 °C
V_F (typ.)	0.48 V

1 Characteristics

Table 1. Absolute ratings (limiting values, at 25 °C unless otherwise specified)

Symbol	Parameter	Value	Unit
V_{RRM}	Repetitive peak reverse voltage	60	V
$I_{F(RMS)}$	Forward rms current	30	A
$I_{F(AV)}$	Average forward current	$T_c = 135\text{ °C}, \delta = 0.5$	A
I_{FSM}	Surge non repetitive forward current	$t_p = 10\text{ ms sinusoidal}$	A
P_{ARM}	Repetitive peak avalanche power	$t_p = 10\text{ }\mu\text{s}, T_j = 125\text{ °C}$	W
T_{stg}	Storage temperature range	-65 to +175	°C
T_j	Maximum operating junction temperature ⁽¹⁾	150	°C

1. $(dP_{tot}/dT_j) < (1/R_{th(j-a)})$ condition to avoid thermal runaway for a diode on its own heatsink.

Table 2. Thermal resistance parameters

Symbol	Parameter	Max. value	Unit
$R_{th(j-c)}$	Junction to case	1.6	°C/W

Table 3. Static electrical characteristics

Symbol	Parameter	Test conditions	Min.	Typ.	Max.	Unit	
$I_R^{(1)}$	Reverse leakage current	$T_j = 25\text{ °C}$	$V_R = V_{RRM}$	-		350	μA
		$T_j = 125\text{ °C}$		-	65	95	mA
$V_F^{(2)}$	Forward voltage drop	$T_j = 25\text{ °C}$	$I_F = 10\text{ A}$	-		0.60	V
		$T_j = 125\text{ °C}$		-	0.48	0.56	
		$T_j = 25\text{ °C}$	$I_F = 20\text{ A}$	-		0.74	
		$T_j = 125\text{ °C}$		-	0.62	0.70	

1. $t_p = 5\text{ ms}, \delta < 2\%$

2. $t_p = 380\text{ }\mu\text{s}, \delta < 2\%$

To evaluate the conduction losses, use the following equation:

$$P = 0.42 \times I_{F(AV)} + 0.014 \times I_{F(RMS)}^2$$

For more information, please refer to the following application notes related to the power losses :

- AN604: Calculation of conduction losses in a power rectifier
- AN4021: Calculation of reverse losses on a power diode

1.1 Characteristics (curves)

Figure 1. Average forward power dissipation versus average forward current

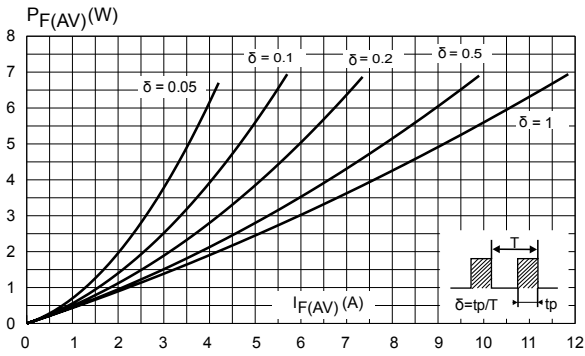

Figure 2. Average forward current versus ambient temperature ($\delta = 0.5$)

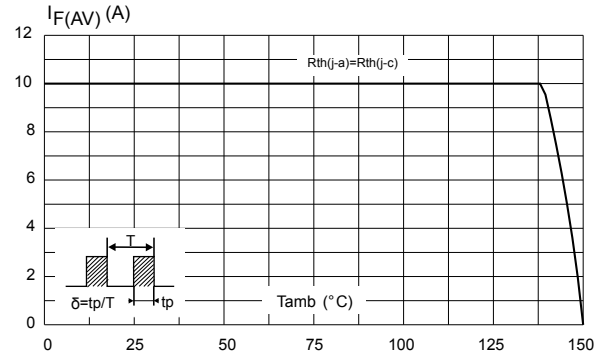

Figure 3. Normalized avalanche power derating versus pulse duration ($T_j = 125^{\circ}C$)

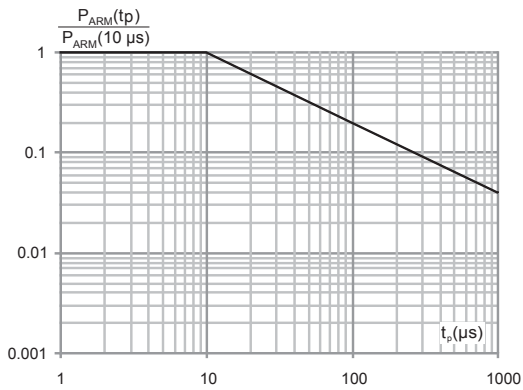

Figure 4. Relative variation of thermal impedance junction to case versus pulse duration

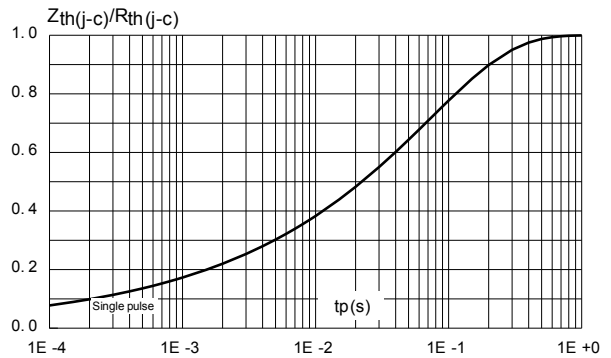

Figure 5. Reverse leakage current versus reverse voltage applied (typical values)

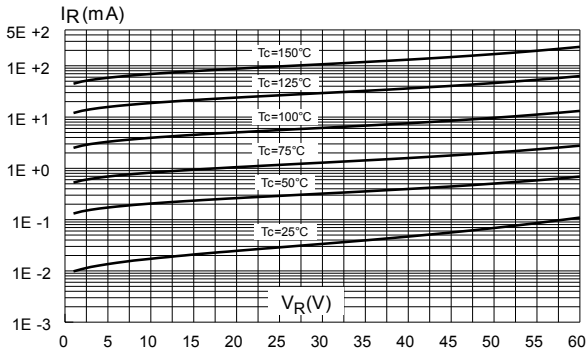

Figure 6. Junction capacitance versus reverse voltage applied (typical values)

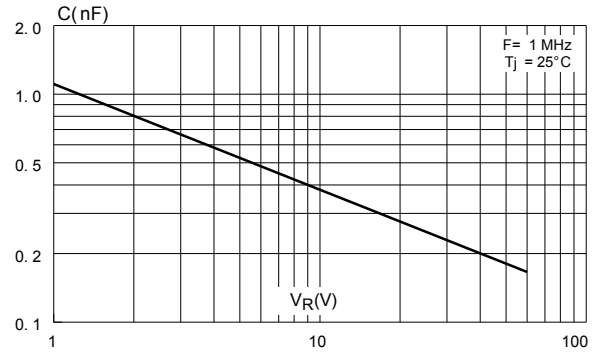
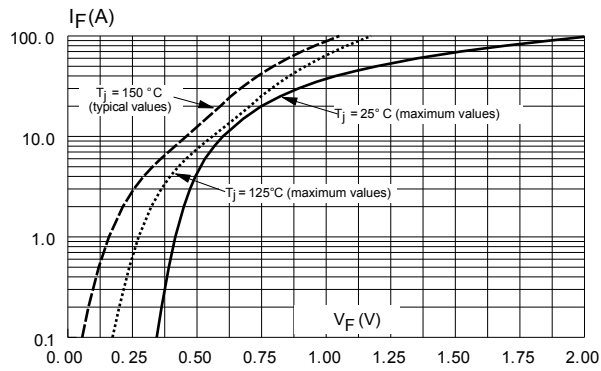

Figure 7. Forward voltage drop versus forward current.



2 Package information

In order to meet environmental requirements, ST offers these devices in different grades of ECOPACK® packages, depending on their level of environmental compliance. ECOPACK® specifications, grade definitions and product status are available at: www.st.com. ECOPACK® is an ST trademark.

2.1 TO-220AC package information

- Cooling method: by conduction (C)
- Epoxy meets UL94,V0
- Recommended torque value: 0.55 N·m
- Maximum torque value: 0.70 N·m

Figure 8. TO-220AC package outline

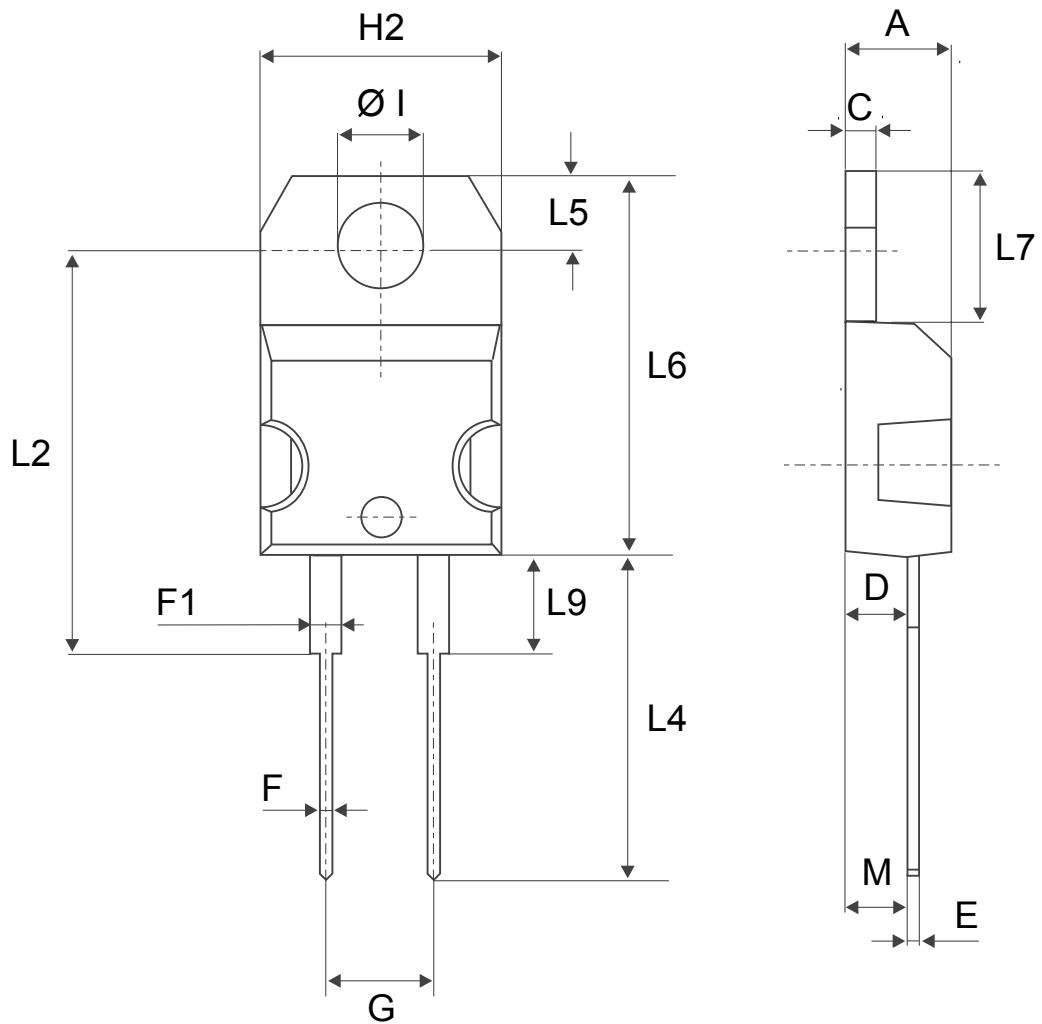

Table 4. TO-220AC package mechanical data

Ref.	Dimensions			
	Millimeters		Inches	
	Min.	Max.	Min.	Max.
A	4.40	4.60	0.173	0.181
C	1.23	1.32	0.048	0.051
D	2.40	2.72	0.094	0.107
E	0.49	0.70	0.019	0.027
F	0.61	0.88	0.024	0.034
F1	1.14	1.70	0.044	0.066
G	4.95	5.15	0.194	0.202
H2	10.00	10.40	0.393	0.409
L2	16.40 typ.		0.645 typ.	
L4	13.00	14.00	0.511	0.551
L5	2.65	2.95	0.104	0.116
L6	15.25	15.75	0.600	0.620
L7	6.20	6.60	0.244	0.259
L9	3.50	3.93	0.137	0.154
M	2.6 typ.		0.102 typ.	
Diam	3.75	3.85	0.147	0.151

3 Ordering Information

Table 5. Ordering information

Order code	Marking	Package	Weight	Base qty.	Delivery mode
STPS10L60D	STPS10L60D	TO-220AC	1.86 g	50	Tube

Revision history

Table 6. Document revision history

Date	Version	Changes
July-2003	4B	Previous release.
25-May-2018	5	Removed TO-220FPAC package. Removed figure 4, 5.1, 5.2 and 6.2. Updated Table 1. Absolute ratings (limiting values, at 25 °C unless otherwise specified) and Section 1.1 Characteristics (curves) . Minor text changes to improve readability.

IMPORTANT NOTICE – PLEASE READ CAREFULLY

STMicroelectronics NV and its subsidiaries (“ST”) reserve the right to make changes, corrections, enhancements, modifications, and improvements to ST products and/or to this document at any time without notice. Purchasers should obtain the latest relevant information on ST products before placing orders. ST products are sold pursuant to ST’s terms and conditions of sale in place at the time of order acknowledgement.

Purchasers are solely responsible for the choice, selection, and use of ST products and ST assumes no liability for application assistance or the design of Purchasers’ products.

No license, express or implied, to any intellectual property right is granted by ST herein.

Resale of ST products with provisions different from the information set forth herein shall void any warranty granted by ST for such product.

ST and the ST logo are trademarks of ST. All other product or service names are the property of their respective owners.

Information in this document supersedes and replaces information previously supplied in any prior versions of this document.

© 2018 STMicroelectronics – All rights reserved

Mouser Electronics

Authorized Distributor

Click to View Pricing, Inventory, Delivery & Lifecycle Information:

[STMicroelectronics:](#)

[STPS10L60D](#)