

THIS DRAWING IS UNPUBLISHED. RELEASED FOR PUBLICATION 20
 © COPYRIGHT 20 BY - ALL RIGHTS RESERVED.

LOC		DIST		REVISIONS			
GP	00	P	LTR	DESCRIPTION	DATE	DWN	APVD
		D2		REVISED PER ECR-17-005823	15MAY2017	O.C	D.Z

- 1 MATERIAL: HOUSING; PBT GLASS FILLED UL94V-0
PIN; BRASS
- 2 FINISH: PIN, 1.0µm MIN TIN OVER 0.8µm MIN NICKEL.
- 3 SKETCH SHOWS NO PIN MISSING.

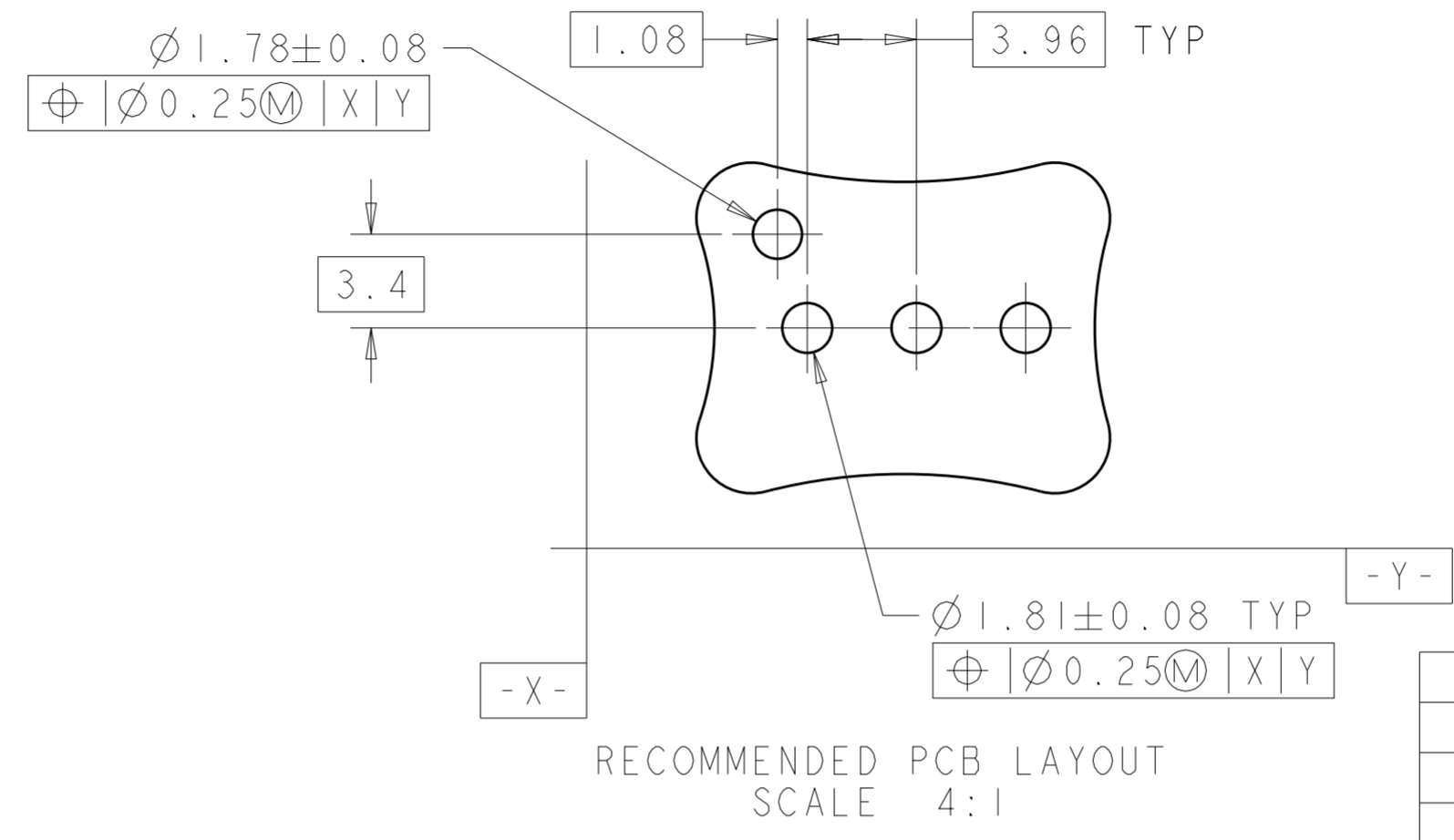
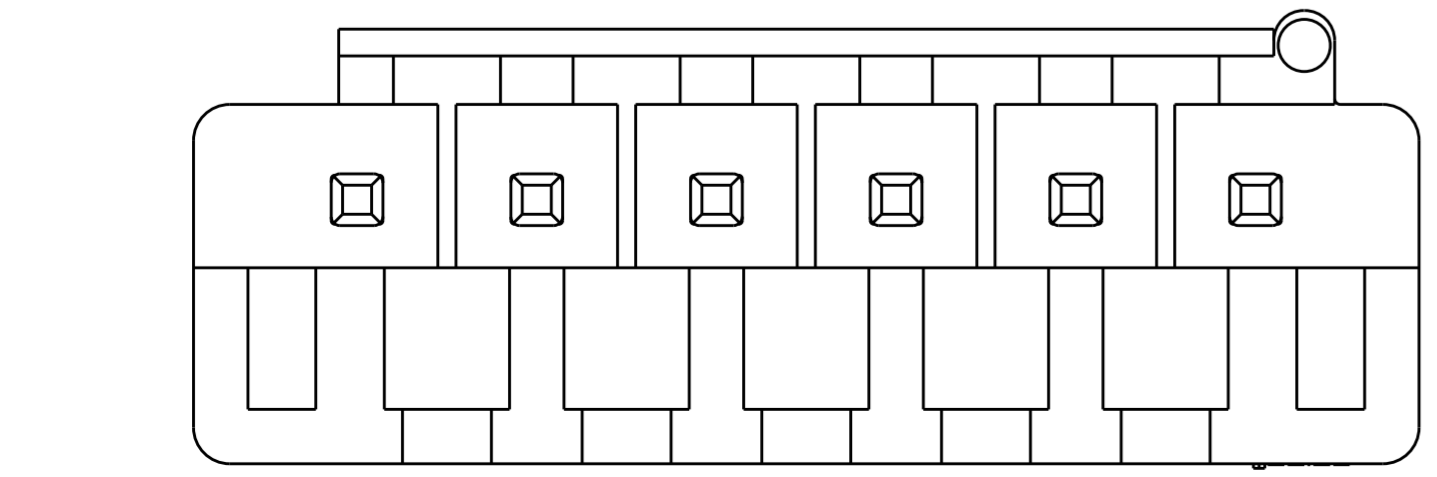
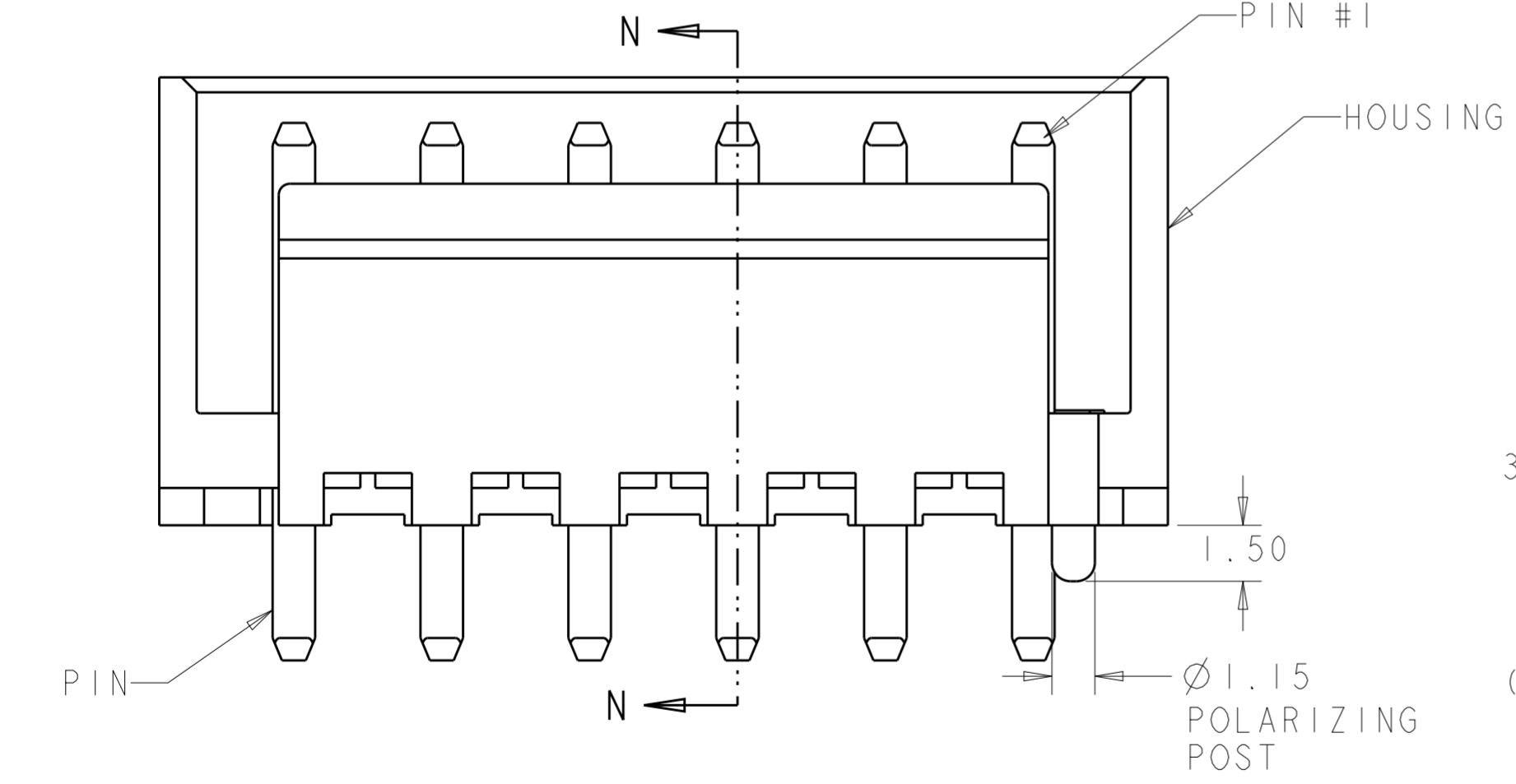
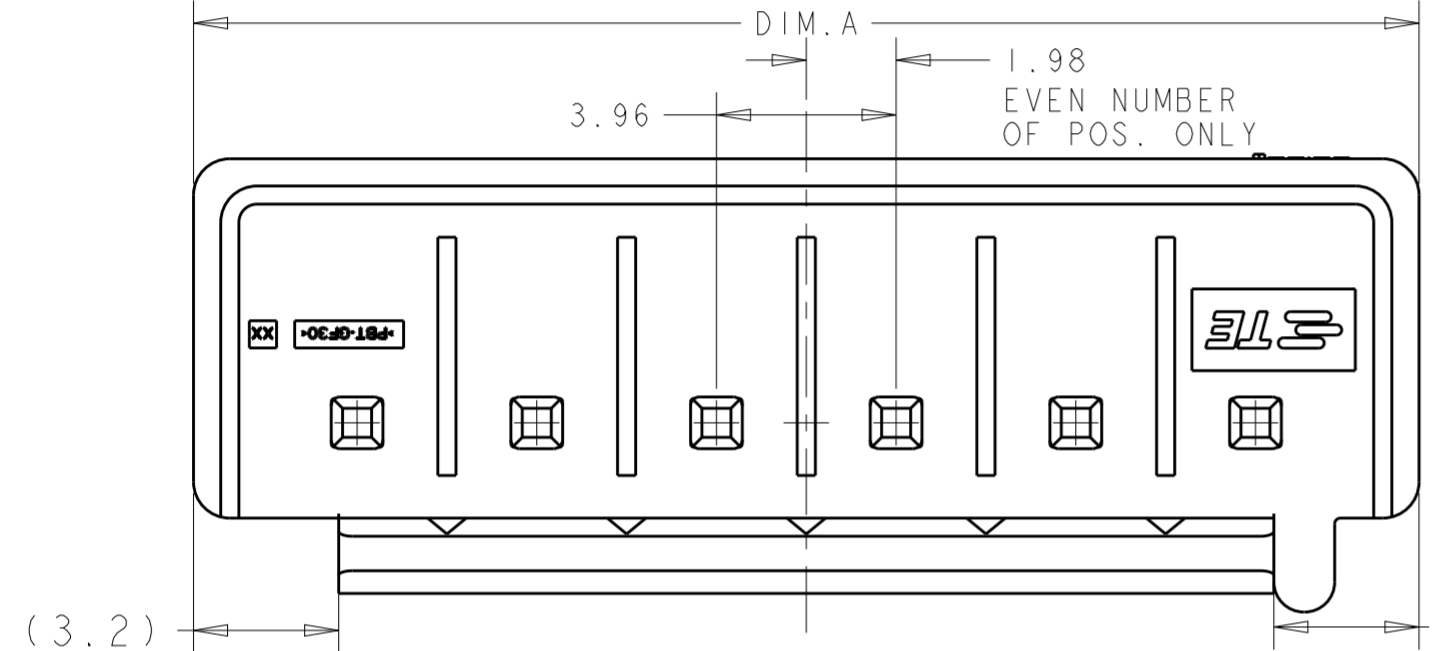
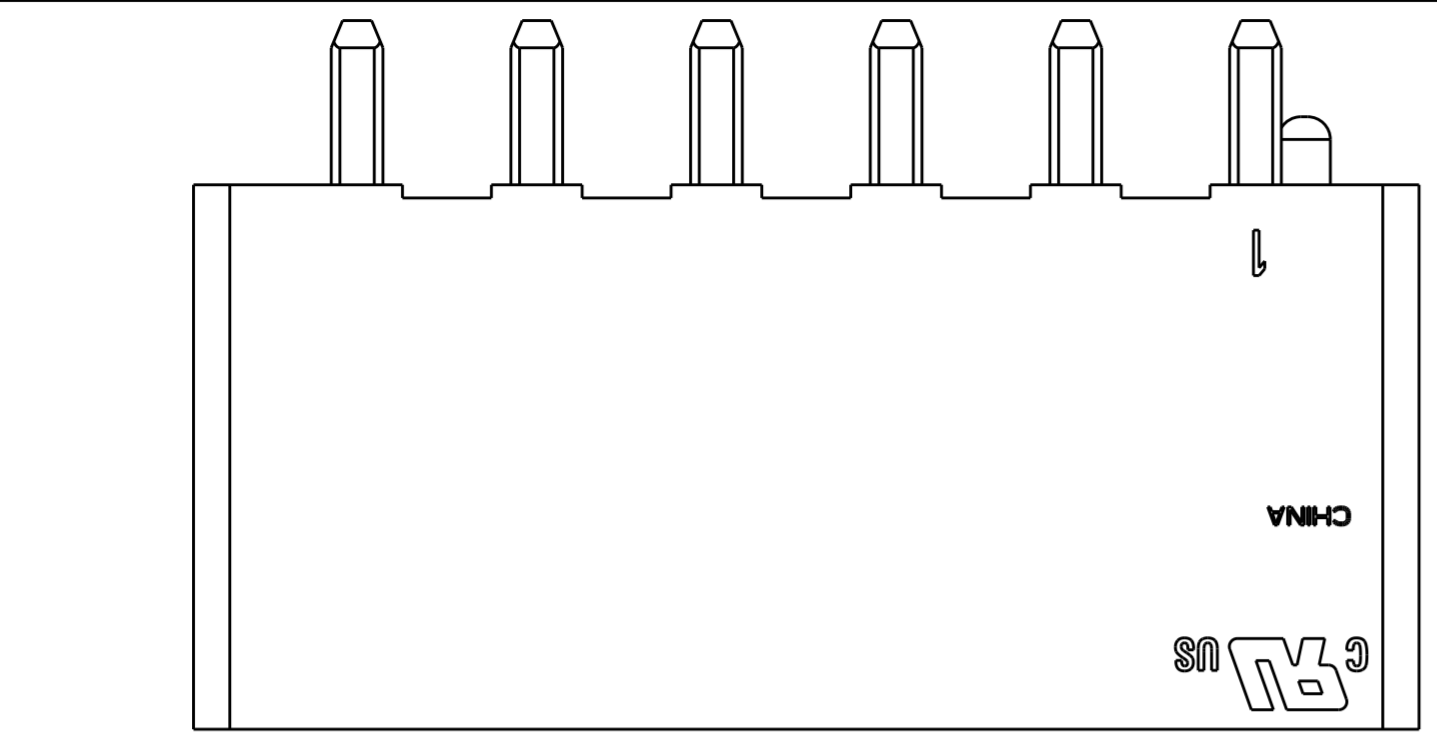

RECOMMENDED PCB LAYOUT
SCALE 4:1

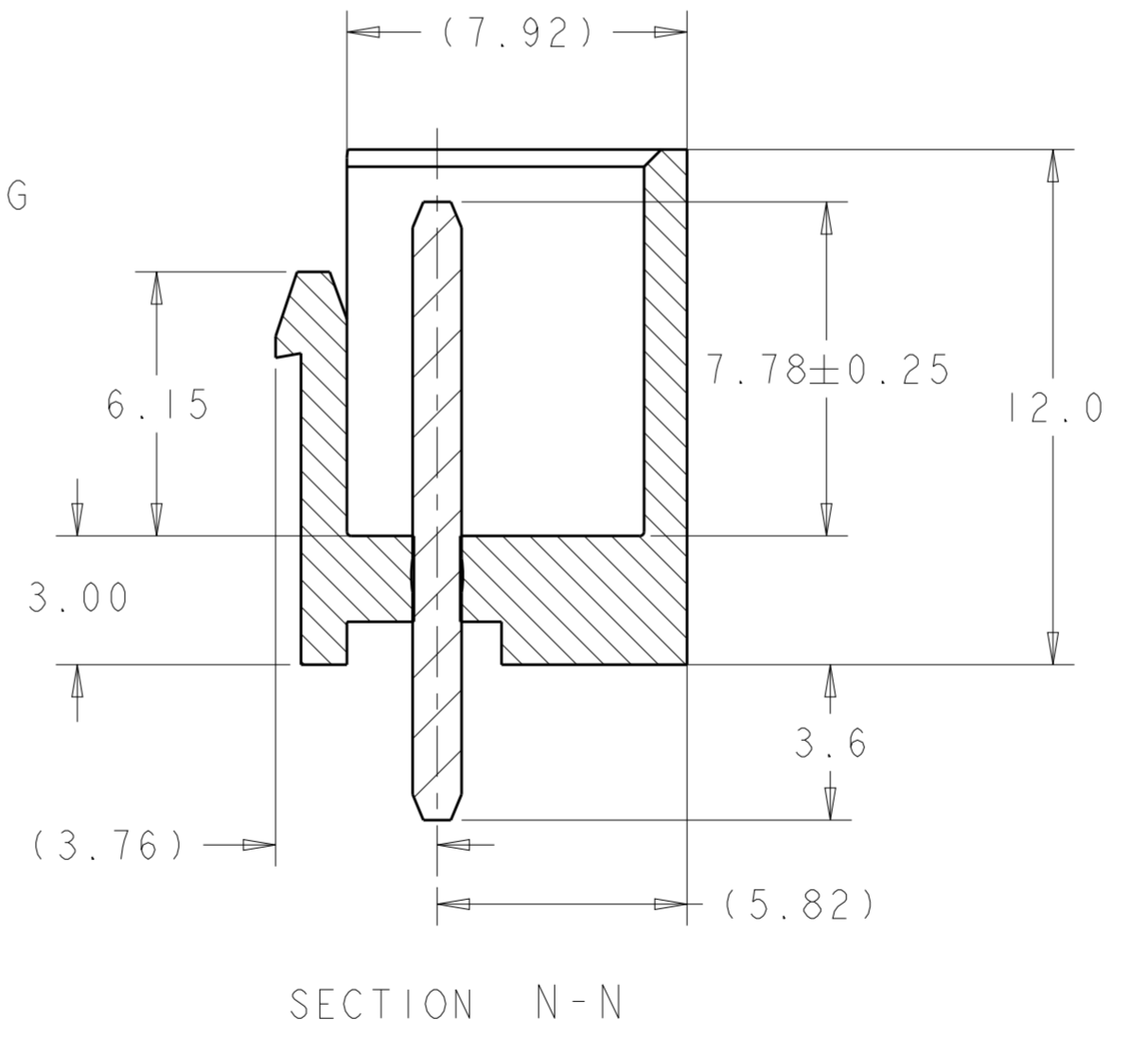

COLOR	DIM.A	OMIT PIN#	POS.	ASSEMBLY PART NO.
WHITE	30.97	6	7	1-1877285-7
WHITE	23.05	3	5	1-1877285-5
BLACK	50.77	-	12	3-1877285-2
BLACK	46.81	-	11	3-1877285-1
BLACK	42.85	-	10	3-1877285-0
BLACK	38.89	-	9	2-1877285-9
BLACK	34.93	-	8	2-1877285-8
BLACK	30.97	-	7	2-1877285-7
BLACK	27.01	-	6	2-1877285-6
BLACK	23.05	-	5	2-1877285-5
BLACK	19.09	-	4	2-1877285-4
BLACK	15.13	-	3	2-1877285-3
BLACK	11.17	-	2	2-1877285-2
WHITE	50.77	-	12	1-1877285-2
WHITE	46.81	-	11	1-1877285-1
WHITE	42.85	-	10	1-1877285-0
WHITE	38.89	-	9	1877285-9
WHITE	34.93	-	8	1877285-8
WHITE	30.97	-	7	1877285-7
WHITE	27.01	-	6	1877285-6
WHITE	23.05	-	5	1877285-5
WHITE	19.09	-	4	1877285-4
WHITE	15.13	-	3	1877285-3
WHITE	11.17	-	2	1877285-2

THIS DRAWING IS A CONTROLLED DOCUMENT.

DWN: W.G. LENKER 03OCT2005
 CHK: R. WALKER 03OCT2005
 APVD: S. RIDGILL 10SEP2008

PRODUCT SPEC: 108-5609
 APPLICATION SPEC: -

MATERIAL: 1
 FINISH: 2

NAME: SHROUDED HEADER ASSEMBLY, 2 THRU 12 POSITION, SINGLE LATCH, 3.96mm PITCH, ECONOMY POWER (EP)

SIZE: A2
 CAGE CODE: 00779
 DRAWING NO: C-1877285

RESTRICTED TO: -

CUSTOMER DRAWING SCALE: 6:1 SHEET 1 OF 1 REV D2

Mouser Electronics

Authorized Distributor

Click to View Pricing, Inventory, Delivery & Lifecycle Information:

[TE Connectivity:](#)

[1877285-7](#)