

# MJH11017, MJH11019, MJH11021 (PNP) MJH11018, MJH11020, MJH11022 (NPN)



ON Semiconductor®

[www.onsemi.com](http://www.onsemi.com)

## Complementary Darlington Silicon Power Transistors

These devices are designed for use as general purpose amplifiers, low frequency switching and motor control applications.

### Features

- High DC Current Gain @ 10 A<sub>dc</sub> — h<sub>FE</sub> = 400 Min (All Types)
- Collector–Emitter Sustaining Voltage
  - V<sub>CEO(sus)</sub> = 150 Vdc (Min) — MJH11018, 17
  - = 200 Vdc (Min) — MJH11020, 19
  - = 250 Vdc (Min) — MJH11022, 21
- Low Collector–Emitter Saturation Voltage
  - V<sub>CE(sat)</sub> = 1.2 V (Typ) @ I<sub>C</sub> = 5.0 A
  - = 1.8 V (Typ) @ I<sub>C</sub> = 10 A
- Monolithic Construction
- These are Pb–Free Devices

### MAXIMUM RATINGS

Rating	Symbol	Max	Unit
Collector–Emitter Voltage MJH11018, MJH11017 MJH11020, MJH11019 MJH11022, MJH11021	V <sub>CEO</sub>	150 200 250	Vdc
Collector–Base Voltage MJH11018, MJH11017 MJH11020, MJH11019 MJH11022, MJH11021	V <sub>CB</sub>	150 200 250	Vdc
Emitter–Base Voltage	V <sub>EB</sub>	5.0	Vdc
Collector Current – Continuous – Peak (Note 1)	I <sub>C</sub>	15 30	A <sub>dc</sub>
Base Current	I <sub>B</sub>	0.5	A <sub>dc</sub>
Total Device Dissipation @ T <sub>C</sub> = 25°C Derate above 25°C	P <sub>D</sub>	150 1.2	W W/°C
Operating and Storage Junction Temperature Range	T <sub>J</sub> , T <sub>stg</sub>	–65 to +150	°C

### THERMAL CHARACTERISTICS

Characteristic	Symbol	Max	Unit
Thermal Resistance, Junction–to–Case	R <sub>θJC</sub>	0.83	°C/W

Stresses exceeding those listed in the Maximum Ratings table may damage the device. If any of these limits are exceeded, device functionality should not be assumed, damage may occur and reliability may be affected.

1. Pulse Test: Pulse Width = 5.0 ms, Duty Cycle ≤ 10%.

## 15 AMPERE DARLINGTON COMPLEMENTARY SILICON POWER TRANSISTORS 150–250 VOLTS, 150 WATTS

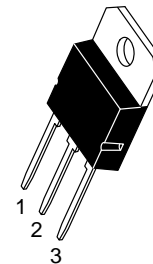
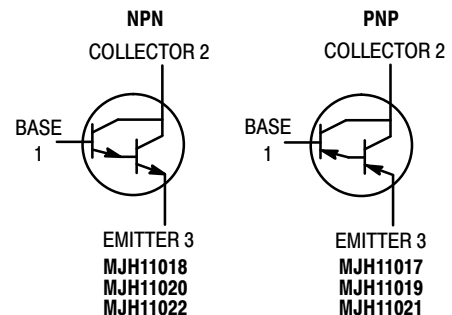

SOT-93  
(TO-218)  
CASE 340D  
STYLE 1

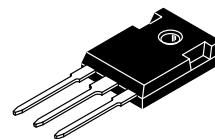

TO-247  
CASE 340L  
STYLE 3

**NOTE:** Effective June 2012 this device will be available only in the TO-247 package. Reference FPCN# 16827.

### ORDERING INFORMATION

See detailed ordering and shipping information in the package dimensions section on page 2 of this data sheet.

# MJH11017, MJH11019, MJH11021 (PNP) MJH11018, MJH11020, MJH11022 (NPN)

## MARKING DIAGRAMS

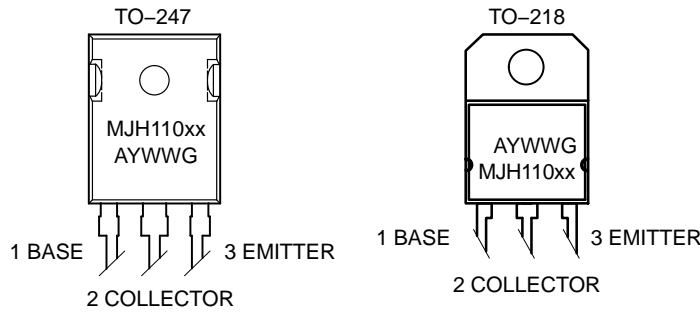

A = Assembly Location  
 Y = Year  
 WW = Work Week  
 G = Pb-Free Package  
 MJH110xx = Device Code  
 xx = 17, 19, 21, 18, 20, 22

## ORDERING INFORMATION

Device Order Number	Package Type	Shipping
MJH11017G	TO-218 (Pb-Free)	30 Units / Rail
MJH11018G	TO-218 (Pb-Free)	30 Units / Rail
MJH11019G	TO-218 (Pb-Free)	30 Units / Rail
MJH11020G	TO-218 (Pb-Free)	30 Units / Rail
MJH11021G	TO-218 (Pb-Free)	30 Units / Rail
MJH11022G	TO-218 (Pb-Free)	30 Units / Rail
MJH11017G	TO-247 (Pb-Free)	30 Units / Rail
MJH11018G	TO-247 (Pb-Free)	30 Units / Rail
MJH11019G	TO-247 (Pb-Free)	30 Units / Rail
MJH11020G	TO-247 (Pb-Free)	30 Units / Rail
MJH11021G	TO-247 (Pb-Free)	30 Units / Rail
MJH11022G	TO-247 (Pb-Free)	30 Units / Rail

# MJH11017, MJH11019, MJH11021 (PNP) MJH11018, MJH11020, MJH11022 (NPN)

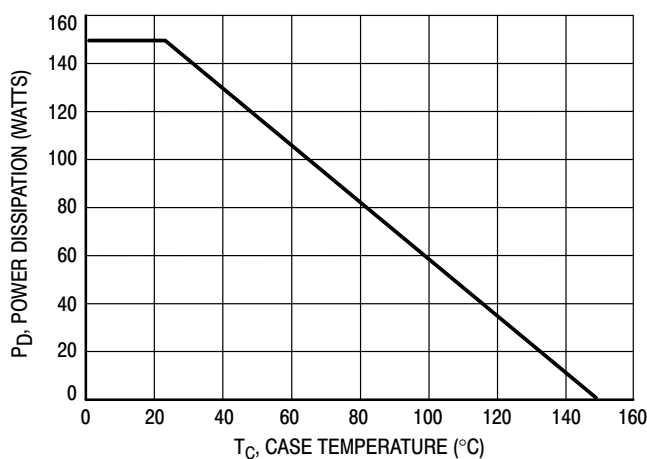

Figure 1. Power Derating

## ELECTRICAL CHARACTERISTICS (T<sub>C</sub> = 25°C unless otherwise noted)

Characteristic	Symbol	Min	Max	Unit
<b>OFF CHARACTERISTICS</b>				
Collector–Emitter Sustaining Voltage (Note 2) (I <sub>C</sub> = 0.1 Adc, I <sub>B</sub> = 0)	V <sub>CEO(sus)</sub>	150 200 250	– – –	Vdc
Collector Cutoff Current (V <sub>CE</sub> = 75 Vdc, I <sub>B</sub> = 0) (V <sub>CE</sub> = 100 Vdc, I <sub>B</sub> = 0) (V <sub>CE</sub> = 125 Vdc, I <sub>B</sub> = 0)	I <sub>CEO</sub>	– – –	1.0 1.0 1.0	mAdc
Collector Cutoff Current (V <sub>CE</sub> = Rated V <sub>CB</sub> , V <sub>BE(off)</sub> = 1.5 Vdc) (V <sub>CE</sub> = Rated V <sub>CB</sub> , V <sub>BE(off)</sub> = 1.5 Vdc, T <sub>J</sub> = 150°C)	I <sub>CEV</sub>	– –	0.5 5.0	mAdc
Emitter Cutoff Current (V <sub>BE</sub> = 5.0 Vdc I <sub>C</sub> = 0)	I <sub>EBO</sub>	–	2.0	mAdc
<b>ON CHARACTERISTICS (Note 2)</b>				
DC Current Gain (I <sub>C</sub> = 10 Adc, V <sub>CE</sub> = 5.0 Vdc) (I <sub>C</sub> = 15 Adc, V <sub>CE</sub> = 5.0 Vdc)	h <sub>FE</sub>	400 100	15,000 –	–
Collector–Emitter Saturation Voltage (I <sub>C</sub> = 10 Adc, I <sub>B</sub> = 100 mA) (I <sub>C</sub> = 15 Adc, I <sub>B</sub> = 150 mA)	V <sub>CE(sat)</sub>	– –	2.5 4.0	Vdc
Base–Emitter On Voltage (I <sub>C</sub> = 10 A, V <sub>CE</sub> = 5.0 Vdc)	V <sub>BE(on)</sub>	–	2.8	Vdc
Base–Emitter Saturation Voltage (I <sub>C</sub> = 15 Adc, I <sub>B</sub> = 150 mA)	V <sub>BE(sat)</sub>	–	3.8	Vdc

## DYNAMIC CHARACTERISTICS

Current–Gain Bandwidth Product (I <sub>C</sub> = 10 Adc, V <sub>CE</sub> = 3.0 Vdc, f = 1.0 MHz)	f <sub>T</sub>	3.0	–	–
Output Capacitance (V <sub>CB</sub> = 10 Vdc, I <sub>E</sub> = 0, f = 0.1 MHz)	C <sub>ob</sub>	– –	400 600	pF
Small–Signal Current Gain (I <sub>C</sub> = 10 Adc, V <sub>CE</sub> = 3.0 Vdc, f = 1.0 kHz)	h <sub>fe</sub>	75	–	–

## SWITCHING CHARACTERISTICS

Characteristic	Symbol	Typical		Unit
		NPN	PNP	
Delay Time	t <sub>d</sub>	150	75	ns
Rise Time	t <sub>r</sub>	1.2	0.5	μs
Storage Time	t <sub>s</sub>	4.4	2.7	μs
Fall Time	t <sub>f</sub>	2.5	2.5	μs

(V<sub>CC</sub> = 100 V, I<sub>C</sub> = 10 A, I<sub>B</sub> = 100 mA  
V<sub>BE(off)</sub> = 5.0 V) (See Figure 2)

2. Pulse Test: Pulse Width = 300 μs, Duty Cycle ≤ 2.0%.

# MJH11017, MJH11019, MJH11021 (PNP) MJH11018, MJH11020, MJH11022 (NPN)

$R_B$  &  $R_C$  varied to obtain desired current levels  
 $D_1$ , must be fast recovery types, e.g.:  
 1N5825 used above  $I_B \approx 100$  mA  
 MSD6100 used below  $I_B \approx 100$  mA

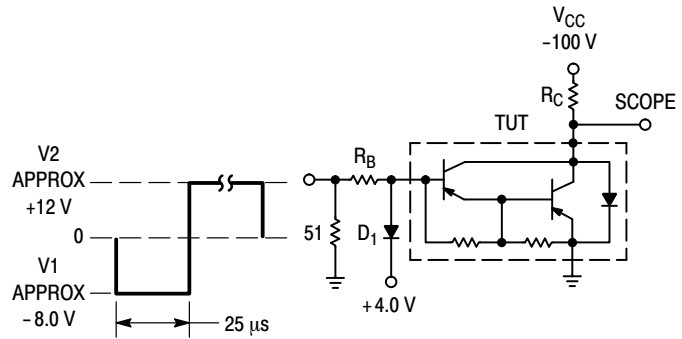

$t_r, t_f \leq 10$  ns  
 Duty Cycle = 1.0% For NPN test circuit, reverse diode and voltage polarities.

For  $t_d$  and  $t_r$ ,  $D_1$  is disconnected and  $V_2 = 0$

Figure 2. Switching Times Test Circuit

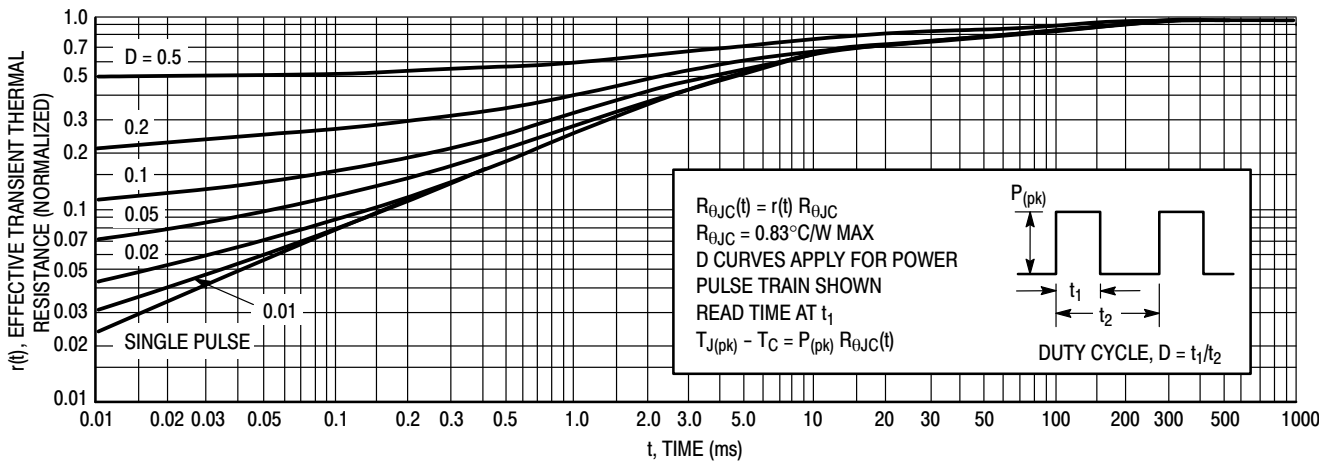

Figure 3. Thermal Response

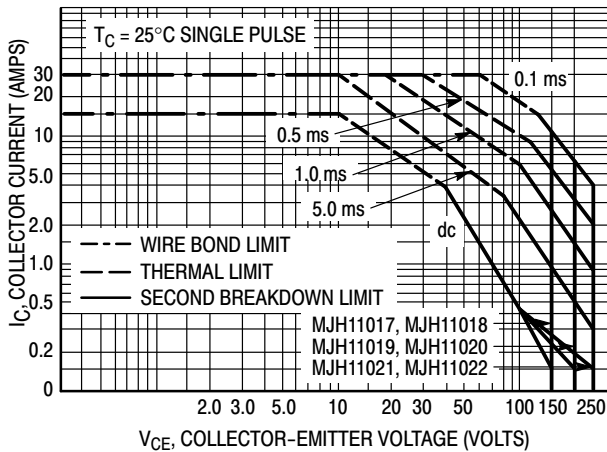

Figure 4. Maximum Rated Forward Bias Safe Operating Area (FBSOA)

## FORWARD BIAS

There are two limitations on the power handling ability of a transistor: average junction temperature and second breakdown. Safe operating area curves indicate  $I_C - V_{CE}$  limits of the transistor that must be observed for reliable operation; i.e., the transistor must not be subjected to greater dissipation than the curves indicate.

The data of Figure 4 is based on  $T_{J(pk)} = 150^\circ\text{C}$ ;  $T_C$  is variable depending on conditions. Second breakdown pulse limits are valid for duty cycles to 10% provided  $T_{J(pk)} \leq 150^\circ\text{C}$ .  $T_{J(pk)}$  may be calculated from the data in Figure 3. At high case temperatures, thermal limitations will reduce the power that can be handled to values less than the limitations imposed by second breakdown.

MJH11017, MJH11019, MJH11021 (PNP) MJH11018, MJH11020, MJH11022 (NPN)

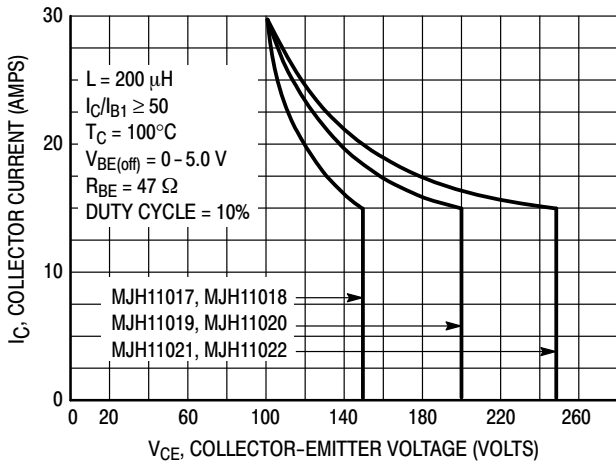

Figure 5. Maximum Rated Reverse Bias Safe Operating Area (RBSOA)

REVERSE BIAS

For inductive loads, high voltage and high current must be sustained simultaneously during turn-off, in most cases, with the base to emitter junction reverse biased. Under these conditions the collector voltage must be held to a safe level at or below a specific value of collector current. This can be accomplished by several means such as active clamping, RC snubbing, load line shaping, etc. The safe level for these devices is specified as Reverse Bias Safe Operating Area and represents the voltage-current conditions during reverse biased turn-off. This rating is verified under clamped conditions so that the device is never subjected to an avalanche mode. Figure 5 gives RBSOA characteristics.

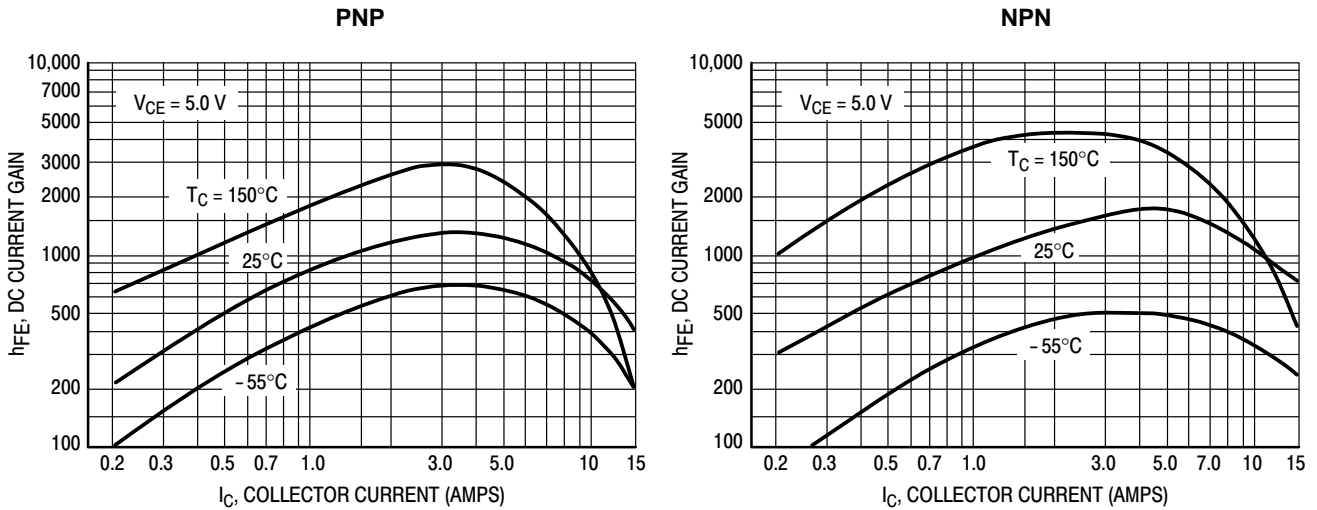

Figure 6. DC Current Gain

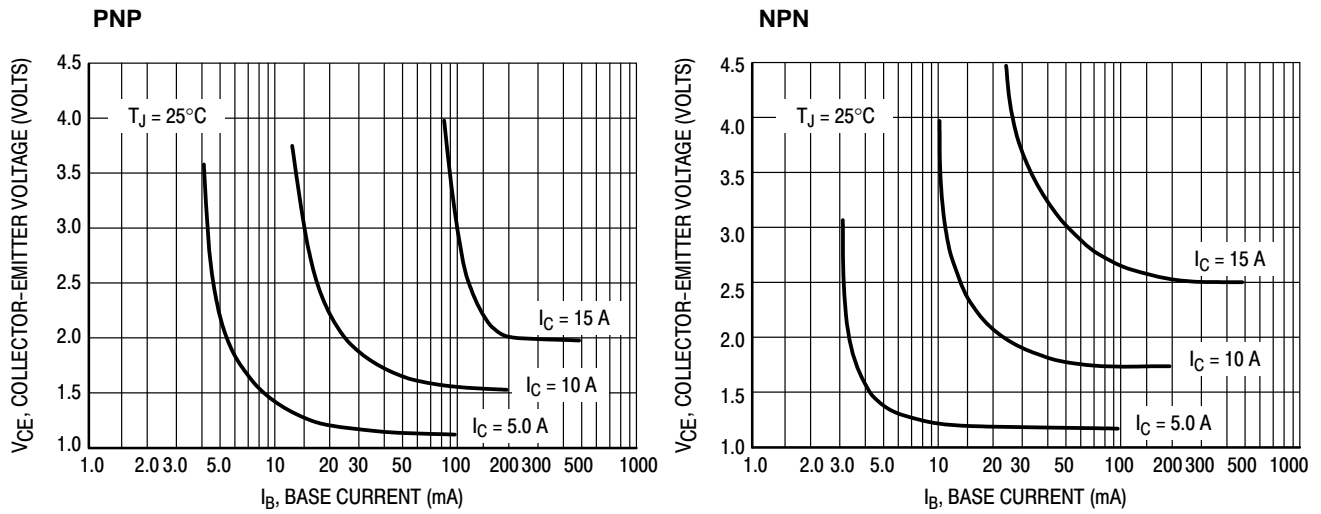

Figure 7. Collector Saturation Region

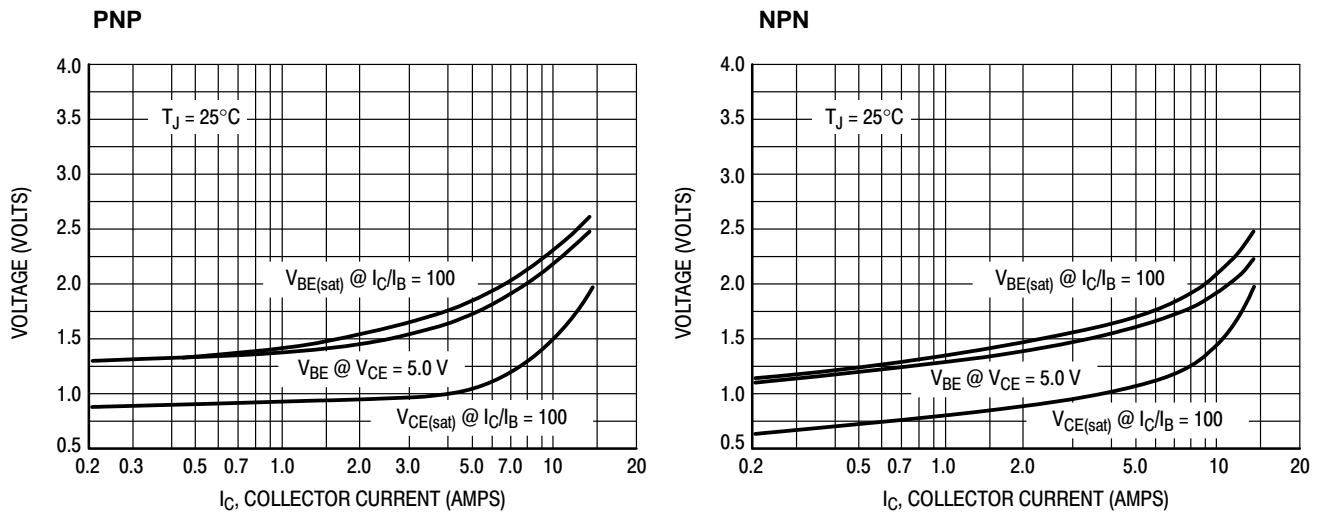

Figure 8. "On" Voltages

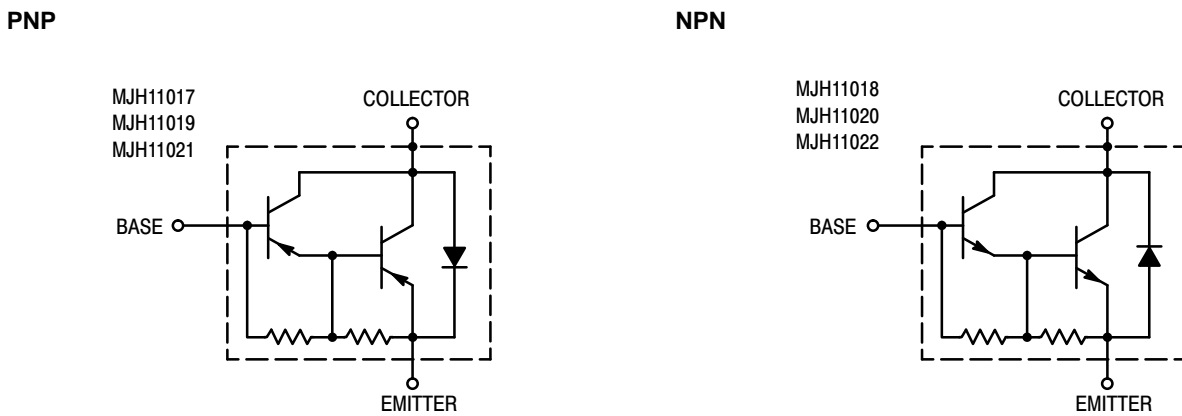
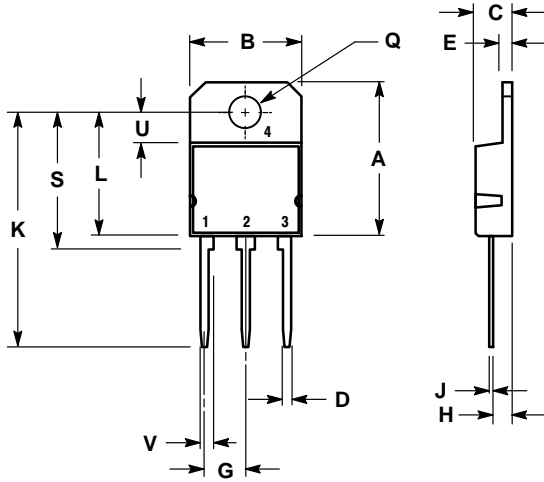

Figure 9. Darlington Schematic

# MJH11017, MJH11019, MJH11021 (PNP) MJH11018, MJH11020, MJH11022 (NPN)

## PACKAGE DIMENSIONS

### SOT-93 (TO-218) CASE 340D-02 ISSUE E



- NOTES:  
1. DIMENSIONING AND TOLERANCING PER ANSI Y14.5M, 1982.  
2. CONTROLLING DIMENSION: MILLIMETER.

DIM	MILLIMETERS		INCHES	
	MIN	MAX	MIN	MAX
A	---	20.35	---	0.801
B	14.70	15.20	0.579	0.598
C	4.70	4.90	0.185	0.193
D	1.10	1.30	0.043	0.051
E	1.17	1.37	0.046	0.054
G	5.40	5.55	0.213	0.219
H	2.00	3.00	0.079	0.118
J	0.50	0.78	0.020	0.031
K	31.00 REF		1.220 REF	
L	---	16.20	---	0.638
Q	4.00	4.10	0.158	0.161
S	17.80	18.20	0.701	0.717
U	4.00 REF		0.157 REF	
V	1.75 REF		0.069	

- STYLE 1:  
PIN 1. BASE  
2. COLLECTOR  
3. EMITTER  
4. COLLECTOR

### TO-247 CASE 340L-02 ISSUE F

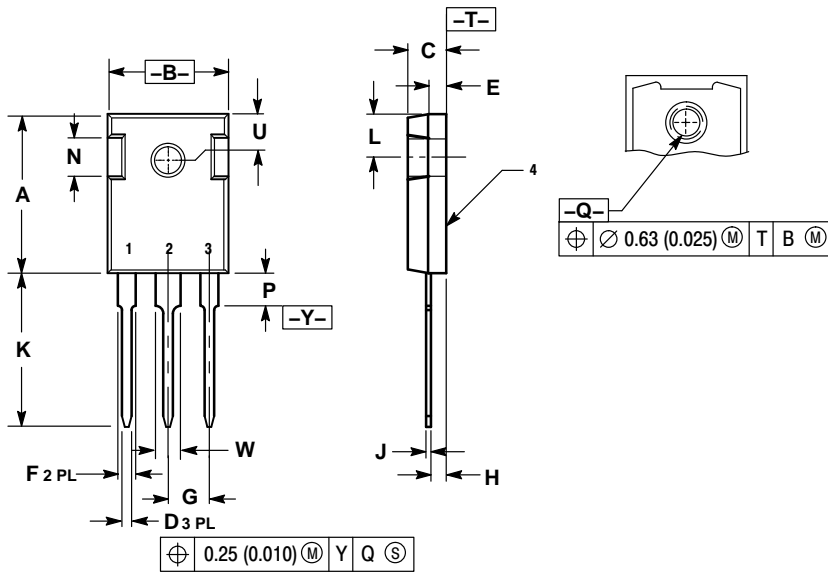

- NOTES:  
1. DIMENSIONING AND TOLERANCING PER ANSI Y14.5M, 1982.  
2. CONTROLLING DIMENSION: MILLIMETER.

DIM	MILLIMETERS		INCHES	
	MIN	MAX	MIN	MAX
A	20.32	21.08	0.800	0.830
B	15.75	16.26	0.620	0.640
C	4.70	5.30	0.185	0.209
D	1.00	1.40	0.040	0.055
E	1.90	2.60	0.075	0.102
F	1.65	2.13	0.065	0.084
G	5.45 BSC		0.215 BSC	
H	1.50	2.49	0.059	0.098
J	0.40	0.80	0.016	0.031
K	19.81	20.83	0.780	0.820
L	5.40	6.20	0.212	0.244
N	4.32	5.49	0.170	0.216
P	---	4.50	---	0.177
Q	3.55	3.65	0.140	0.144
U	6.15 BSC		0.242 BSC	
W	2.87	3.12	0.113	0.123

- STYLE 3:  
PIN 1. BASE  
2. COLLECTOR  
3. EMITTER  
4. COLLECTOR

ON Semiconductor and  are trademarks of Semiconductor Components Industries, LLC dba ON Semiconductor or its subsidiaries in the United States and/or other countries. ON Semiconductor owns the rights to a number of patents, trademarks, copyrights, trade secrets, and other intellectual property. A listing of ON Semiconductor's product/patent coverage may be accessed at [www.onsemi.com/site/pdf/Patent-Marking.pdf](http://www.onsemi.com/site/pdf/Patent-Marking.pdf). ON Semiconductor reserves the right to make changes without further notice to any products herein. ON Semiconductor makes no warranty, representation or guarantee regarding the suitability of its products for any particular purpose, nor does ON Semiconductor assume any liability arising out of the application or use of any product or circuit, and specifically disclaims any and all liability, including without limitation special, consequential or incidental damages. Buyer is responsible for its products and applications using ON Semiconductor products, including compliance with all laws, regulations and safety requirements or standards, regardless of any support or applications information provided by ON Semiconductor. "Typical" parameters which may be provided in ON Semiconductor data sheets and/or specifications can and do vary in different applications and actual performance may vary over time. All operating parameters, including "Typicals" must be validated for each customer application by customer's technical experts. ON Semiconductor does not convey any license under its patent rights nor the rights of others. ON Semiconductor products are not designed, intended, or authorized for use as a critical component in life support systems or any FDA Class 3 medical devices or medical devices with a same or similar classification in a foreign jurisdiction or any devices intended for implantation in the human body. Should Buyer purchase or use ON Semiconductor products for any such unintended or unauthorized application, Buyer shall indemnify and hold ON Semiconductor and its officers, employees, subsidiaries, affiliates, and distributors harmless against all claims, costs, damages, and expenses, and reasonable attorney fees arising out of, directly or indirectly, any claim of personal injury or death associated with such unintended or unauthorized use, even if such claim alleges that ON Semiconductor was negligent regarding the design or manufacture of the part. ON Semiconductor is an Equal Opportunity/Affirmative Action Employer. This literature is subject to all applicable copyright laws and is not for resale in any manner.

#### PUBLICATION ORDERING INFORMATION

##### LITERATURE FULFILLMENT:

Literature Distribution Center for ON Semiconductor  
P.O. Box 5163, Denver, Colorado 80217 USA  
**Phone:** 303-675-2175 or 800-344-3860 Toll Free USA/Canada  
**Fax:** 303-675-2176 or 800-344-3867 Toll Free USA/Canada  
**Email:** [orderlit@onsemi.com](mailto:orderlit@onsemi.com)

**N. American Technical Support:** 800-282-9855 Toll Free  
USA/Canada  
**Europe, Middle East and Africa Technical Support:**  
Phone: 421 33 790 2910  
**Japan Customer Focus Center**  
Phone: 81-3-5817-1050

**ON Semiconductor Website:** [www.onsemi.com](http://www.onsemi.com)  
**Order Literature:** <http://www.onsemi.com/orderlit>  
For additional information, please contact your local  
Sales Representative



# Mouser Electronics

Authorized Distributor

Click to View Pricing, Inventory, Delivery & Lifecycle Information:

[ON Semiconductor:](#)

[MJH11017G](#) [MJH11019G](#) [MJH11020G](#) [MJH11021G](#) [MJH11022G](#)