



# 120×120×38 mm

San Ace 120 9G type

## General Specifications

- Material ..... Frame: Plastic (Flammability: UL 94V-0), Impeller: Plastic (Flammability: UL 94V-1)
- Expected life ..... See the table below. (L10 life: 90% survival rate for continuous operation in free air at 60°C, rated voltage)
- Motor protection function ..... Locked rotor burnout protection, Reverse polarity protection  
For details, please refer to p. 529.
- Dielectric strength ..... 50/60 Hz, 500 VAC, for 1 minute (between lead wire conductors and frame)
- Insulation resistance ..... 10 MΩ or more with a 500 VDC megger (between lead wire conductors and frame)
- Sound pressure level (SPL) ..... At 1 m away from the air inlet
- Storage temperature ..... -30 to +70°C (Non-condensing)
- Lead wire ..... ⊕Red ⊖Black or Blue (Sensor) Yellow
- Mass ..... 330 g

## Specifications

The models listed below **have ribs and pulse sensors**. For models without ribs, append "1" to the end of model numbers.

Model no.	Rated voltage [V]	Operating voltage range [V]	Rated current [A]	Rated input [W]	Rated speed [min <sup>-1</sup> ]	Max. airflow [m <sup>3</sup> /min] [CFM]	Max. static pressure [Pa] [inchH <sub>2</sub> O]	SPL [dB (A)]	Operating temperature [°C]	Expected life [h]
9G1212G101	12	10.2 to 13.8	0.98	11.76	3600	3.88 137	135 0.542	49	-20 to +70	40000/60°C
9G1212E101			0.61	7.32	3100	3.34 118	100 0.402	46		
9G1212H101		7 to 13.8	0.38	4.56	2600	2.8 99	70.4 0.283	39		
9G1212F101			0.28	3.36	2280	2.45 87	54.2 0.218	36		
9G1212M101			0.21	2.52	1950	2.1 74	39.6 0.159	32		
9G1224G101	24	20.4 to 27.6	0.5	12	3600	3.88 137	135 0.542	49		
9G1224E101			0.34	8.16	3100	3.34 118	100 0.402	46		
9G1224H101		14 to 27.6	0.22	5.28	2600	2.8 99	70.4 0.283	39		
9G1224F101			0.16	3.84	2280	2.45 87	54.2 0.218	36		
9G1224M101			0.11	2.64	1950	2.1 74	39.6 0.159	32		
9G1248G101	48	40.8 to 55.2	0.25	12	3600	3.88 137	135 0.542	49		
9G1248E101			0.17	8.16	3100	3.34 118	100 0.402	46		
9G1248H101			0.11	5.28	2600	2.8 99	70.4 0.283	39		
9G1248F101			0.09	4.32	2280	2.45 87	54.2 0.218	36		
9G1248M101			0.07	3.36	1950	2.1 74	39.6 0.159	32		

Other sensor specifications are available as options. Refer to the index (pp. 549 to 550).

## Airflow - Static Pressure Characteristics

**9G1212G101** With pulse sensor

Operating voltage range

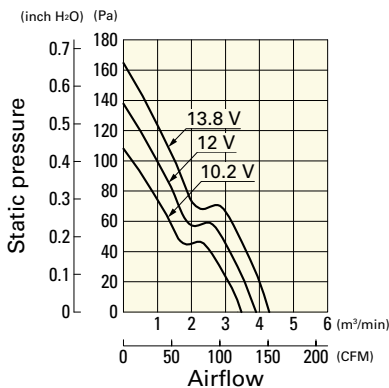

**9G1212E101** With pulse sensor

Operating voltage range

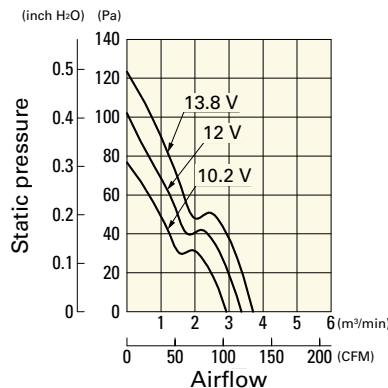

**9G1212H101** With pulse sensor

Operating voltage range

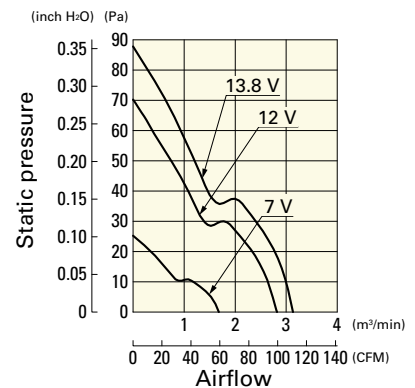

# Airflow - Static Pressure Characteristics

**9G1212F101** With pulse sensor

Operating voltage range

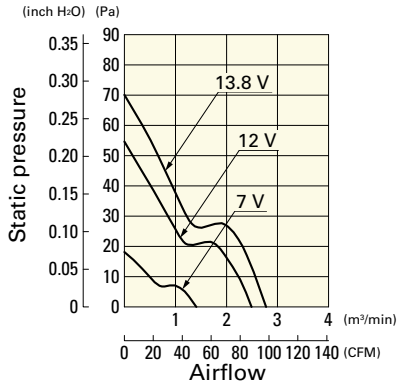

**9G1212M101** With pulse sensor

Operating voltage range

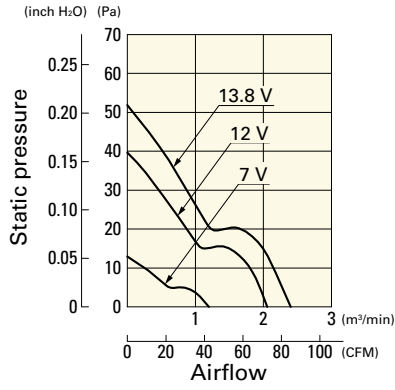

**9G1224G101** With pulse sensor

Operating voltage range

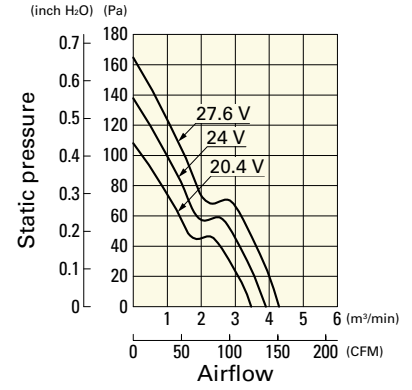

**9G1224E101** With pulse sensor

Operating voltage range

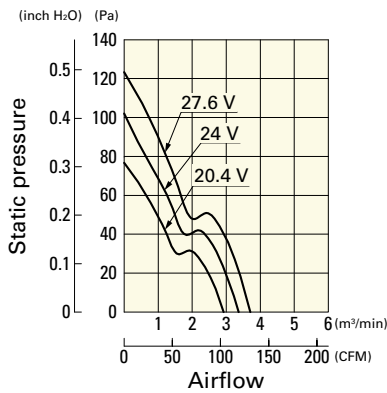

**9G1224H101** With pulse sensor

Operating voltage range

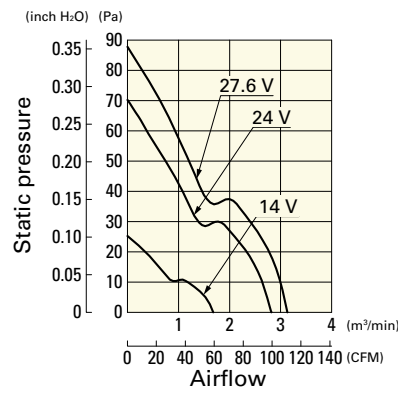

**9G1224F101** With pulse sensor

Operating voltage range

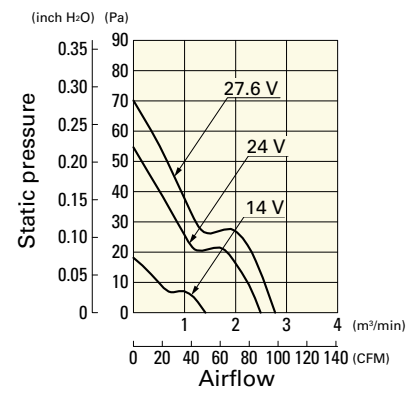

**9G1224M101** With pulse sensor

Operating voltage range

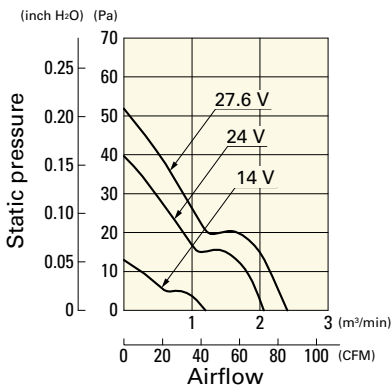

**9G1248G101** With pulse sensor

Operating voltage range

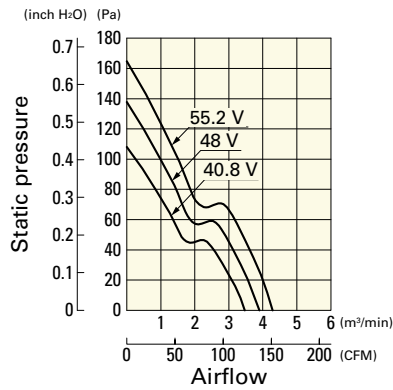

**9G1248E101** With pulse sensor

Operating voltage range

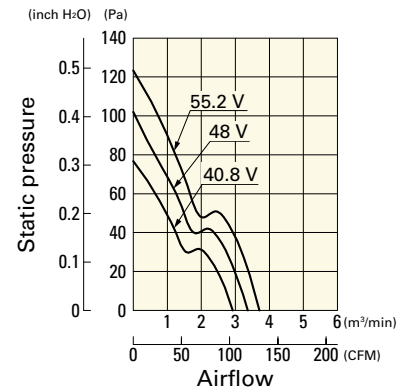

**9G1248H101** With pulse sensor

Operating voltage range

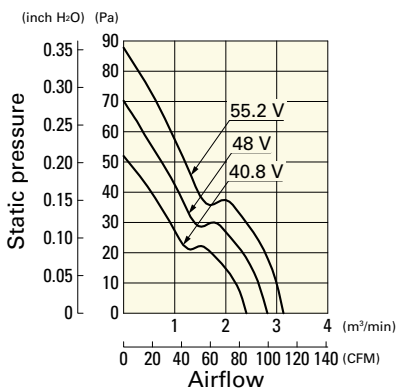

**9G1248F101** With pulse sensor

Operating voltage range

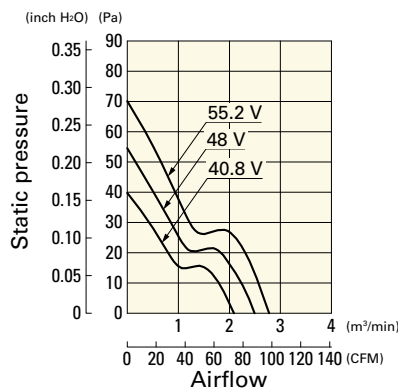

**9G1248M101** With pulse sensor

Operating voltage range

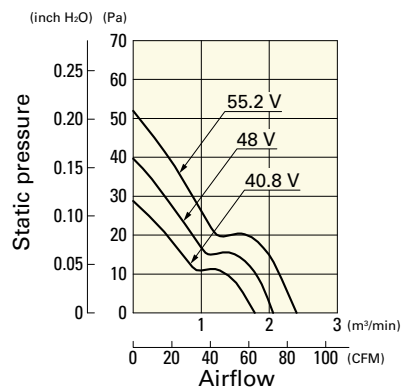

**Dimensions (unit: mm)** (With ribs)

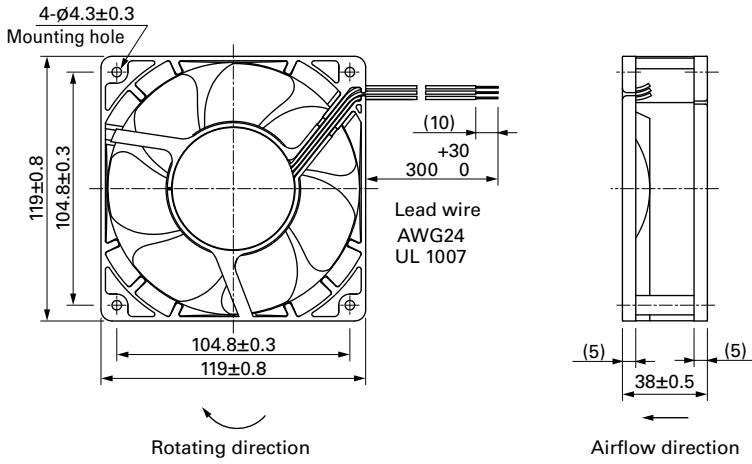

**Reference Dimensions of Mounting Holes and Vent Opening (unit: mm)**

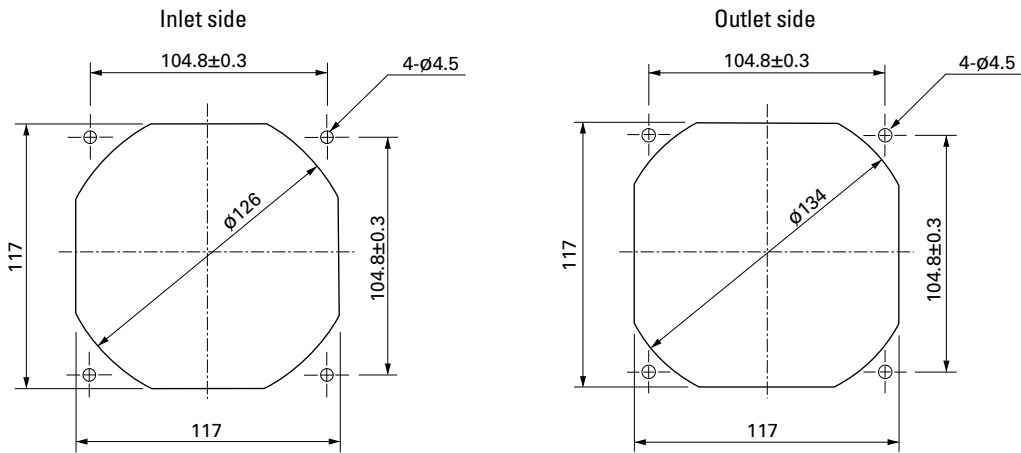

**Options**

**Finger guards**

page: p. 514

Model no.: 109-019C, 109-019H, 109-019E, 109-019K

**Resin finger guards**

page: p. 520

Model no.: 109-1000G

**Resin filter kits**

page: p. 521

Model no.: 109-1000F13 (13PPI), 109-1000F20 (20PPI),  
109-1000F30 (30PPI), 109-1000F40 (40PPI)

# Mouser Electronics

Authorized Distributor

Click to View Pricing, Inventory, Delivery & Lifecycle Information:

## Sanyo Denki:

[9G1212M101](#) [9G1212M1011](#) [9G1224G1011](#) [9G1224H101](#) [9G1248H101](#) [9G1212F102](#) [9G1212H102](#)  
[9G1224E102](#) [9G1224E1021](#) [9G1224H102](#) [9G1224M1021](#) [9G1212H1011](#) [9G1224G101](#) [9G1224M1011](#)  
[9G1248H1011](#) [9G1212M1021](#) [9G1212F101](#) [9G1248E1011](#) [9G1248E102](#) [9G1212G101](#) [9G1248F101](#) [9G1212E102](#)  
[9G1212E101](#) [9G1212E1011](#) [9G1224E101](#) [9G1212E1021](#) [9G1224F102](#) [9G1212M102](#) [9G1248E101](#) [9G1224M101](#)  
[9G1224M102](#) [9G1248E1021](#) [9G1224E1011](#) [9G1224G1021](#) [9G1224F101](#) [9G1224G102](#) [9G1248G101](#)  
[9G1212G1021](#) [9G1248G1011](#) [9G1212H101](#) [9G1224H1D01](#) [9G1212G1011](#) [9G1224F1011](#) [9G1248F1011](#)  
[9G1248M1011](#) [9G1212F1011](#) [9G1248M101](#) [9G1224H1011](#) [9G1212E1D011](#) [9G1212E1D01](#) [9G1212H1021](#)  
[9G1224M1D01](#) [9G1248F1021](#) [9G1248F1D01](#) [9G1224E1D011](#) [9G1248H1D01](#) [9G1248G102](#) [9G1248M1021](#)  
[9G1248G1021](#) [9G1248M1D01](#) [9G1212G1D01](#) [9G1248H1D011](#) [9G1224H1021](#) [9G1248M102](#) [9G1212M1D011](#)  
[9G1248G1D011](#) [9G1224G1D01](#) [9G1224G1D011](#) [9G1248H1021](#) [9G1212G102](#) [9G1212H1D01](#) [9G1224E1D01](#)  
[9G1248E1D01](#) [9G1248F102](#) [9G1248G1D01](#) [9G1212F1021](#) [9G1224F1021](#) [9G1224F1D01](#) [9G1212M1D01](#)  
[9G1224M1D011](#) [9G1212G1D011](#) [9G1212H1D011](#) [9G1248H102](#) [9G1248E1D011](#) [9G1224P1G01](#) [9G1248P1G041](#)  
[9G1224EG101](#) [9G1212P1G04](#) [9G1212P1G081](#) [9G1248P1G04](#)