

THIS DRAWING IS UNPUBLISHED. VERTRAULICHE UNVERÖFFENTLICHTE ZEICHNUNG. RELEASED FOR PUBLICATION FREI FUER VERÖFFENTLICHUNG. 2000. MATED WITH: PASSEND ZU: 1355639

© COPYRIGHT 2000 BY TYCO ELECTRONICS CORPORATION. ALL RIGHTS RESERVED. ALLE RECHTE VORBEHALTEN.

LOC	DIST	REVISIONS					
A	-	P	LTR	DESCRIPTION	DATE	DWN	APVD
PROJEKT NR.: 95-52384			A	New Drawing	31JAN100	ASC	JWO
			B	Locking latch improved	17APR2001	ASC	JWO
			BI	Spec number added	03NOV2003	SBL	ASC

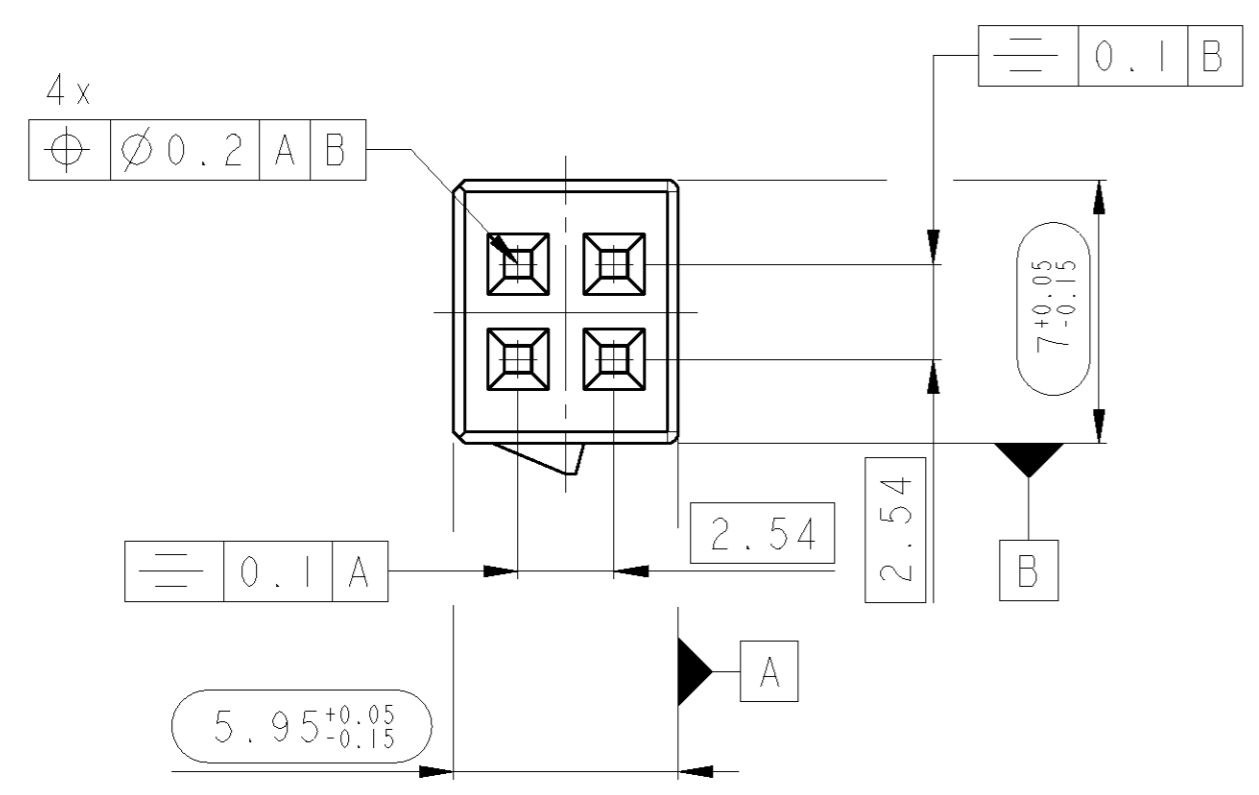

NOTES
Bemerkungen

1. ONLY THE GERMAN-LANGUAGE VERSION SHALL BE BINDING
Massgebend ist der deutsche Text
2. WIRE SIZE RANGE UNTIL 0,75mm²
Drahtgrössenbereich bis 0,75mm²
3. DETAILS OF DESIGN ARE LEFT TO MANUFACTURER
Einzelheiten der Ausführung bleiben dem Hersteller überlassen

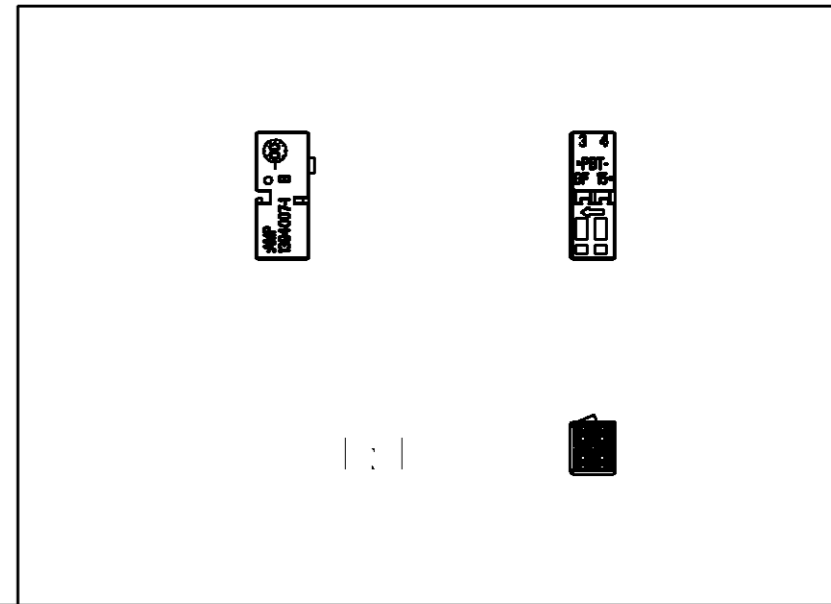
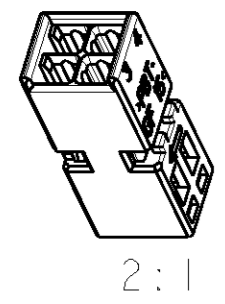
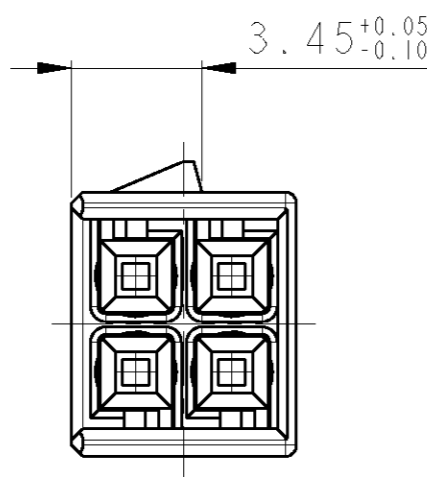
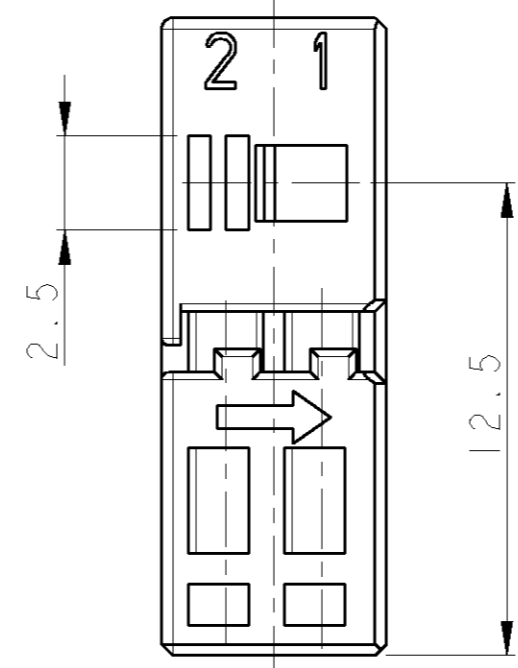
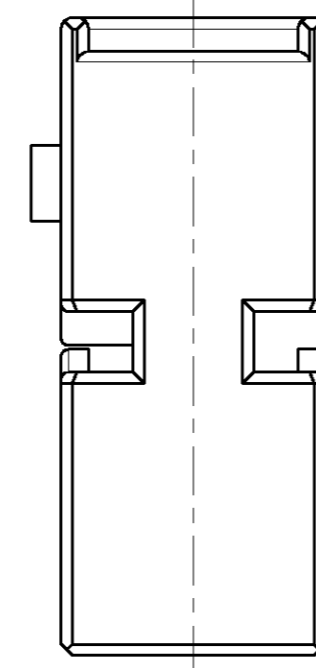
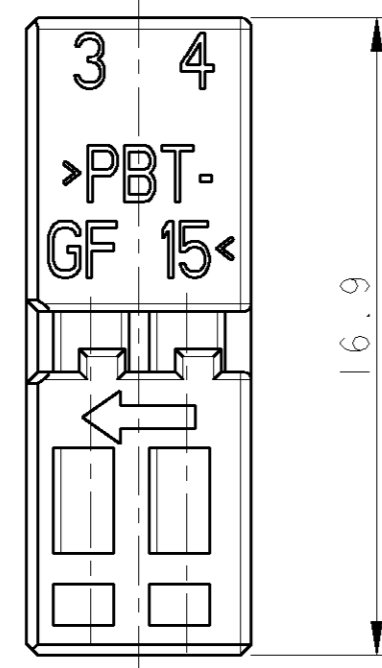
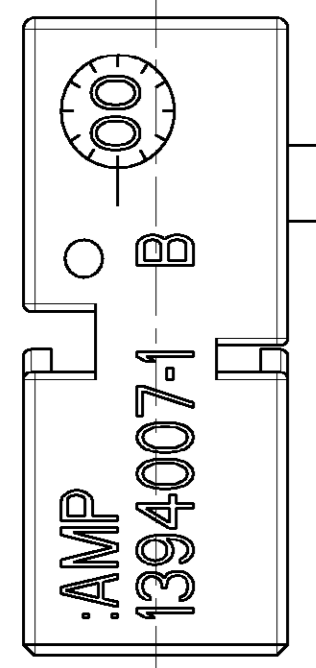

AMP PART NO.	REV.	MATERIAL	SURFACE COLOR	DESCRIPTION	ITEM NO.
1394007-1	B	PBT-GF15	schwarz/BLACK	SOCKET HOUSING	1

<small>THIS DRAWING IS A CONTROLLED DOCUMENT FOR TYCO ELECTRONICS CORPORATION IT IS SUBJECT TO CHANGE AND THE CONTROLLING ENGINEERING ORGANIZATION SHOULD BE CONTACTED FOR THE LATEST REVISION.</small> <small>DIESSES ZEICHNUNGSDOKUMENT WIRD DURCH AMP INCORPORATED KONTROLLIERT. ÄNDERUNGEN, DIE DEN TECHNISCHEN FORTSCHRITT DIESER, SIND VORBEHALTEN. DEN JEWEILS LETZTBESTEHENDEN ÄNDERUNGSSTAND ERFAHREN SIE AUF ANFRAGE.</small>		DWN A. Schroebel	10JAN2000
<small>TOLERANCES UNLESS OTHERWISE SPECIFIED: ALLGEMEINTOLERANZEN DIN 16901-140</small> 0 PLC ± 1 PLC ± 2 PLC ± 3 PLC ± 4 PLC ± <small>ANGLES/WINKEL ±°</small> <small>FINISH/OBERFLÄCHE/FARBE</small>		CHK J. Woller	10JAN2000
<small>DIMENSIONS: MASSEINHEITEN: MM</small> 		APVD -	-
<small>MATERIAL</small> PBT-GF15		PRODUCT SPEC 108-18214	
		APPLICATION SPEC 114-18351	
		WEIGHT 0.47g	
		CUSTOMER DRAWING	/KUNDENZEICHNUNG

		tyco Electronics AMP GmbH D - 64625 Bensheim	
NAME: MOS Buchsengehäuse, 4polig MOS SOCKET HOUSING, 4POS.			
SIZE A2	CAGE CODE 00779	DRAWING NO. 1394007	RESTRICTED TO NUR FUER -
SCALE MASSTAB 5:1	SHEET BLATT	OF VON	REV BI

Mouser Electronics

Authorized Distributor

Click to View Pricing, Inventory, Delivery & Lifecycle Information:

[TE Connectivity:](#)

[1394007-1](#)