

600 V power Schottky silicon carbide diode

Features

- No or negligible reverse recovery
- Switching behavior independent of temperature
- Dedicated to PFC boost diode

Description

The SiC diode is an ultrahigh performance power Schottky diode. It is manufactured using a silicon carbide substrate. The wide bandgap material allows the design of a Schottky diode structure with a 600 V rating. Due to the Schottky construction no recovery is shown at turn-off and ringing patterns are negligible. The minimal capacitive turn-off behavior is independent of temperature.

ST SiC diodes will boost the performance of PFC operations in hard switching conditions.

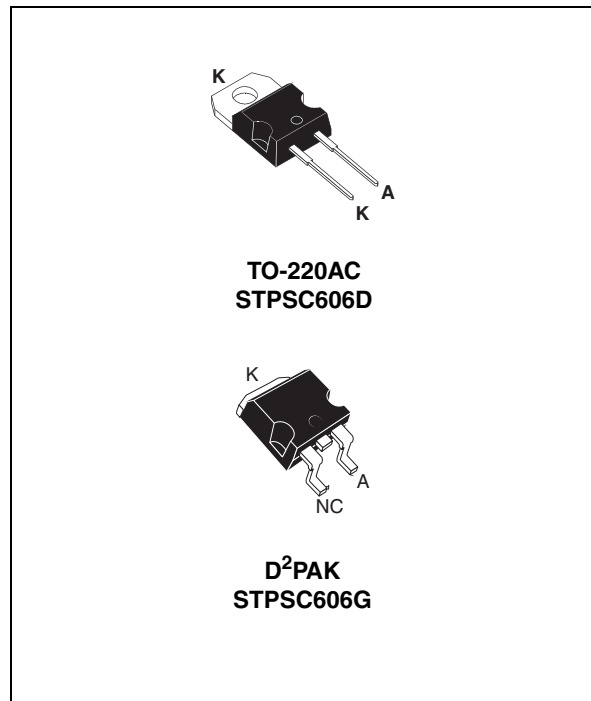

Table 1. Device summary

| | |
|-------------|--------|
| $I_{F(AV)}$ | 6 A |
| V_{RRM} | 600 V |
| $T_j(max)$ | 175 °C |
| $Q_C (typ)$ | 6 nC |

1 Characteristics

Table 2. Absolute ratings (limiting values at 25 °C unless otherwise specified)

| Symbol | Parameter | | Value | Unit |
|--------------|--------------------------------------|--|-------------|------|
| V_{RRM} | Repetitive peak reverse voltage | | 600 | V |
| $I_{F(RMS)}$ | Forward rms current | | 18 | A |
| $I_{F(AV)}$ | Average forward current | $T_c = 125\text{ °C}, \delta = 0.5$ | 6 | A |
| I_{FSM} | Surge non repetitive forward current | $t_p = 10\text{ ms sinusoidal}, T_c = 25\text{ °C}$ | 27 | A |
| | | $t_p = 10\text{ ms sinusoidal}, T_c = 125\text{ °C}$ | 22 | |
| | | $t_p = 10\text{ }\mu\text{s square}, T_c = 25\text{ °C}$ | 110 | |
| I_{FRM} | Repetitive peak forward current | $\delta = 0.1, T_c = 110\text{ °C}, T_j = 150\text{ °C}$ | 27 | A |
| T_{stg} | Storage temperature range | | -55 to +175 | °C |
| T_j | Operating junction temperature range | | -40 to +175 | °C |

Table 3. Thermal resistance

| Symbol | Parameter | Value | Unit |
|---------------|------------------|-------|------|
| $R_{th(j-c)}$ | Junction to case | 2.8 | °C/W |

Table 4. Static electrical characteristics (per diode)

| Symbol | Parameter | Tests conditions | | Min. | Typ. | Max. | Unit |
|-------------|-------------------------|-----------------------|--------------------|------|------|------|---------------|
| $I_R^{(1)}$ | Reverse leakage current | $T_j = 25\text{ °C}$ | $V_R = V_{RRM}$ | - | 15 | 75 | μA |
| | | $T_j = 150\text{ °C}$ | | - | 100 | 750 | |
| $V_F^{(2)}$ | Forward voltage drop | $T_j = 25\text{ °C}$ | $I_F = 6\text{ A}$ | - | 1.4 | 1.7 | V |
| | | $T_j = 150\text{ °C}$ | | - | 1.6 | 2.1 | |

1. $t_p = 10\text{ ms}, \delta < 2\%$
2. $t_p = 500\text{ }\mu\text{s}, \delta < 2\%$

To evaluate the conduction losses use the following equation:

$$P = 1.20 \times I_{F(AV)} + 0.15 \times I_{F(RMS)}^2$$

Table 5. Other parameters

| Symbol | Parameter | Test conditions | Typ. | Unit |
|--------|-------------------------|--|------|------|
| Q_c | Total capacitive charge | $V_r = 400\text{ V}, I_F = 6\text{ A}, di_F/dt = -200\text{ A}/\mu\text{s}$ $T_j = 150\text{ °C}$ | 6 | nC |
| C | Total capacitance | $V_r = 0\text{ V}, T_c = 25\text{ °C}, F = 1\text{ Mhz}$ | 375 | pF |
| | | $V_r = 400\text{ V}, T_c = 25\text{ °C}, F = 1\text{ Mhz}$ | 30 | |

Figure 1. Forward voltage drop versus forward current (typical values)

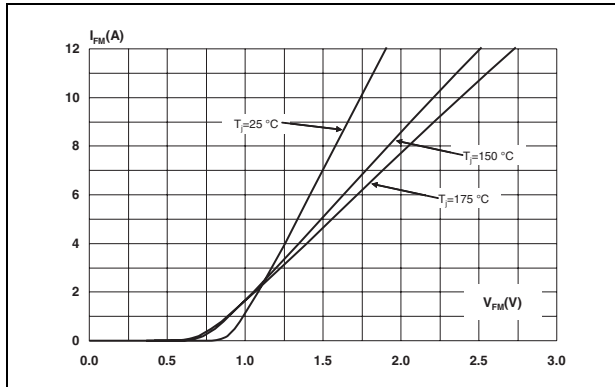

Figure 2. Reverse leakage current versus reverse voltage applied (maximum values)

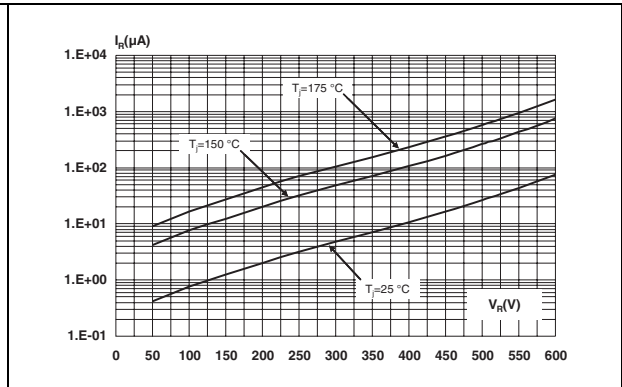

Figure 3. Peak forward current versus case temperature

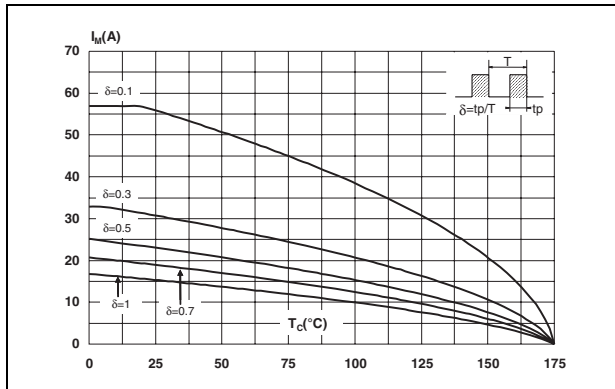

Figure 4. Junction capacitance versus reverse voltage applied (typical values)

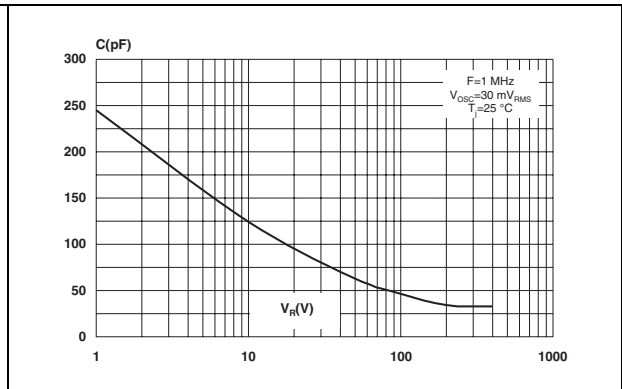

Figure 5. Relative variation of thermal impedance junction to case versus pulse duration

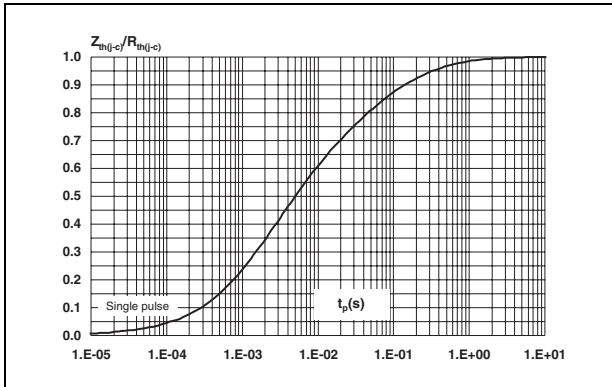

Figure 6. Non-repetitive peak surge forward current versus pulse duration (sinusoidal waveform)

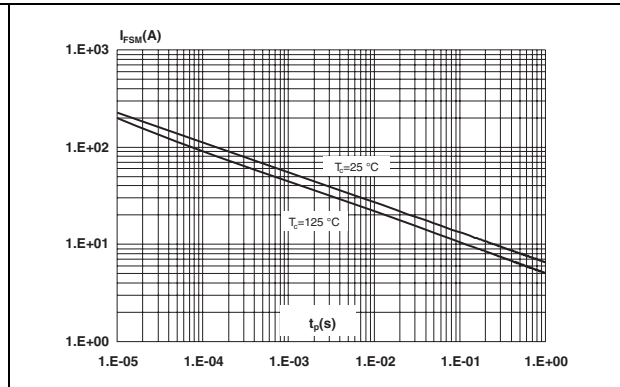
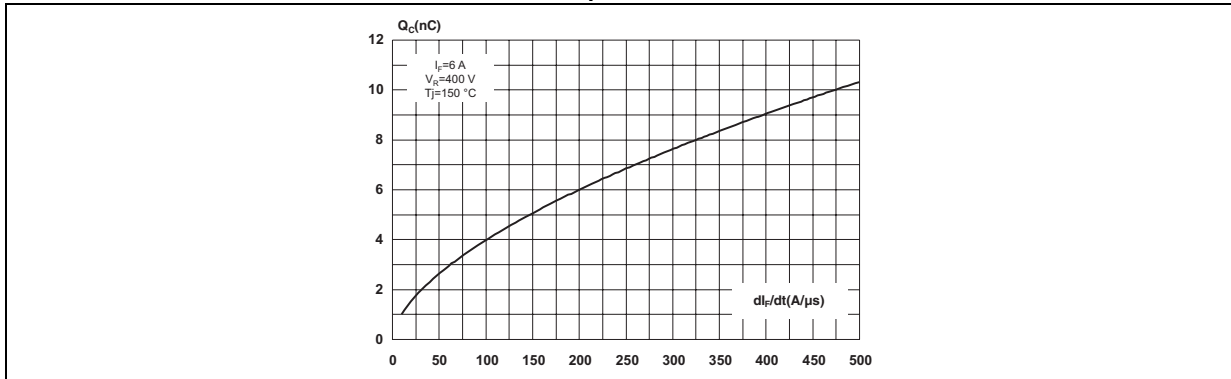

Figure 7. Total capacitive charges versus di_F/dt (typical values)



2 Package information

- Epoxy meets UL94, V0
- Cooling method: convection (C)
- Recommended torque: 0.4 to 0.6 N·m

In order to meet environmental requirements, ST offers these devices in different grades of ECOPACK® packages, depending on their level of environmental compliance. ECOPACK® specifications, grade definitions and product status are available at: www.st.com. ECOPACK® is an ST trademark.

Table 6. TO-220AC dimensions

| Ref. | Dimensions | | | |
|---------|-------------|-------|------------|-------|
| | Millimeters | | Inches | |
| | Min. | Max. | Min. | Max. |
| A | 4.40 | 4.60 | 0.173 | 0.181 |
| C | 1.23 | 1.32 | 0.048 | 0.051 |
| D | 2.40 | 2.72 | 0.094 | 0.107 |
| E | 0.49 | 0.70 | 0.019 | 0.027 |
| F | 0.61 | 0.88 | 0.024 | 0.034 |
| F1 | 1.14 | 1.70 | 0.044 | 0.066 |
| G | 4.95 | 5.15 | 0.194 | 0.202 |
| H2 | 10.00 | 10.40 | 0.393 | 0.409 |
| L2 | 16.40 typ. | | 0.645 typ. | |
| L4 | 13.00 | 14.00 | 0.511 | 0.551 |
| L5 | 2.65 | 2.95 | 0.104 | 0.116 |
| L6 | 15.25 | 15.75 | 0.600 | 0.620 |
| L7 | 6.20 | 6.60 | 0.244 | 0.259 |
| L9 | 3.50 | 3.93 | 0.137 | 0.154 |
| M | 2.6 typ. | | 0.102 typ. | |
| Diam. I | 3.75 | 3.85 | 0.147 | 0.151 |

Table 7. D²PAK dimensions

| Ref. | Dimensions | | | |
|------|-------------|-------|------------|-------|
| | Millimeters | | Inches | |
| | Min. | Max. | Min. | Max. |
| A | 4.40 | 4.60 | 0.173 | 0.181 |
| A1 | 2.49 | 2.69 | 0.098 | 0.106 |
| A2 | 0.03 | 0.23 | 0.001 | 0.009 |
| B | 0.70 | 0.93 | 0.027 | 0.037 |
| B2 | 1.14 | 1.70 | 0.045 | 0.067 |
| C | 0.45 | 0.60 | 0.017 | 0.024 |
| C2 | 1.23 | 1.36 | 0.048 | 0.054 |
| D | 8.95 | 9.35 | 0.352 | 0.368 |
| E | 10.00 | 10.40 | 0.393 | 0.409 |
| G | 4.88 | 5.28 | 0.192 | 0.208 |
| L | 15.00 | 15.85 | 0.590 | 0.624 |
| L2 | 1.27 | 1.40 | 0.050 | 0.055 |
| L3 | 1.40 | 1.75 | 0.055 | 0.069 |
| M | 2.40 | 3.20 | 0.094 | 0.126 |
| R | 0.40 typ. | | 0.016 typ. | |
| V2 | 0° | 8° | 0° | 8° |

Figure 8. Footprint (dimensions in mm)

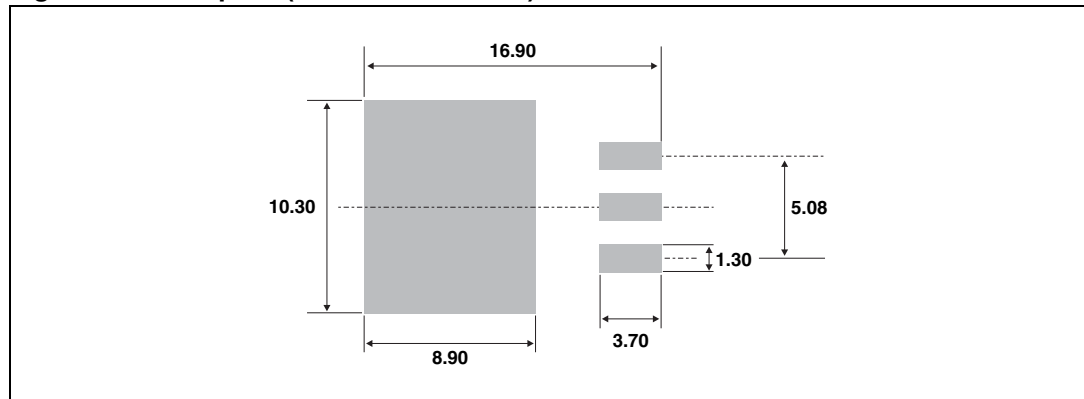

3 Ordering information

Table 8. Ordering information

| Order code | Marking | Package | Weight | Base qty | Delivery mode |
|--------------|-----------|--------------------|--------|----------|---------------|
| STPSC606D | STPSC606D | TO-220AC | 1.86 g | 50 | Tube |
| STPSC606G-TR | STPSC606G | D ² PAK | 1.48 g | 1000 | Tape and reel |

4 Revision history

Table 9. Document revision history

| Date | Revision | Changes |
|-------------|----------|--------------|
| 24-Sep-2009 | 1 | First issue. |

Please Read Carefully:

Information in this document is provided solely in connection with ST products. STMicroelectronics NV and its subsidiaries ("ST") reserve the right to make changes, corrections, modifications or improvements, to this document, and the products and services described herein at any time, without notice.

All ST products are sold pursuant to ST's terms and conditions of sale.

Purchasers are solely responsible for the choice, selection and use of the ST products and services described herein, and ST assumes no liability whatsoever relating to the choice, selection or use of the ST products and services described herein.

No license, express or implied, by estoppel or otherwise, to any intellectual property rights is granted under this document. If any part of this document refers to any third party products or services it shall not be deemed a license grant by ST for the use of such third party products or services, or any intellectual property contained therein or considered as a warranty covering the use in any manner whatsoever of such third party products or services or any intellectual property contained therein.

UNLESS OTHERWISE SET FORTH IN ST'S TERMS AND CONDITIONS OF SALE ST DISCLAIMS ANY EXPRESS OR IMPLIED WARRANTY WITH RESPECT TO THE USE AND/OR SALE OF ST PRODUCTS INCLUDING WITHOUT LIMITATION IMPLIED WARRANTIES OF MERCHANTABILITY, FITNESS FOR A PARTICULAR PURPOSE (AND THEIR EQUIVALENTS UNDER THE LAWS OF ANY JURISDICTION), OR INFRINGEMENT OF ANY PATENT, COPYRIGHT OR OTHER INTELLECTUAL PROPERTY RIGHT.

UNLESS EXPRESSLY APPROVED IN WRITING BY AN AUTHORIZED ST REPRESENTATIVE, ST PRODUCTS ARE NOT RECOMMENDED, AUTHORIZED OR WARRANTED FOR USE IN MILITARY, AIR CRAFT, SPACE, LIFE SAVING, OR LIFE SUSTAINING APPLICATIONS, NOR IN PRODUCTS OR SYSTEMS WHERE FAILURE OR MALFUNCTION MAY RESULT IN PERSONAL INJURY, DEATH, OR SEVERE PROPERTY OR ENVIRONMENTAL DAMAGE. ST PRODUCTS WHICH ARE NOT SPECIFIED AS "AUTOMOTIVE GRADE" MAY ONLY BE USED IN AUTOMOTIVE APPLICATIONS AT USER'S OWN RISK.

Resale of ST products with provisions different from the statements and/or technical features set forth in this document shall immediately void any warranty granted by ST for the ST product or service described herein and shall not create or extend in any manner whatsoever, any liability of ST.

ST and the ST logo are trademarks or registered trademarks of ST in various countries.

Information in this document supersedes and replaces all information previously supplied.

The ST logo is a registered trademark of STMicroelectronics. All other names are the property of their respective owners.

© 2009 STMicroelectronics - All rights reserved

STMicroelectronics group of companies

Australia - Belgium - Brazil - Canada - China - Czech Republic - Finland - France - Germany - Hong Kong - India - Israel - Italy - Japan - Malaysia - Malta - Morocco - Philippines - Singapore - Spain - Sweden - Switzerland - United Kingdom - United States of America

www.st.com

Mouser Electronics

Authorized Distributor

Click to View Pricing, Inventory, Delivery & Lifecycle Information:

[STMicroelectronics:](#)

[STPSC606G-TR](#) [STPSC606D](#)