

FS36-170

Description:

The FS36-170 is a dual primary and dual secondary, split bobbin design which operates with either a parallel input of 115V or a series input of 230V. The output voltage will be either 36.0V with a center-tap under a 0.17A load with the secondaries wired in series, or 18.0V under a 0.34A load with the secondaries wired in parallel. The split bobbin design eliminates the need for costly electrostatic shielding.

Electrical Specifications (@25C)

1. Maximum Power: 6.0VA
2. Primary: Series: 230V; Parallel: 115V
3. Secondary: Series: 36.0V CT @ 0.17A; Parallel: 18.0V @ 0.34A
4. Voltage Regulation: 25% TYP @ full load to no load
5. Temperature Rise: 25C TYP
6. Hipot tested 100% at 2500 VRMS

Construction:

Three flange bobbin construction with primaries and secondaries wound side by side for low capacitive coupling.

Agency File:

UL: File E53148, UL 5085-2 (506), Class B General Purpose Transformer, cUL: File E53148, UL 5085-2 (506), Class B General Purpose Transformer, Canadian Use (CSA 22.2, No.66.2-06)

This model is also available in Class 3, UL 5085-3 (1585) version as [FS36-170-C2](#)



Dimensions:

Units in inches.

H	W	L	A	B	C	D	E	F
1.312	1.312	1.625	0.250	0.350	1.280	0.041	0.020	0.234

Weight: 0.44 lbs

Schematic:



RoHS Compliance: As of manufacturing date February 2005, all standard products meet the requirements of 2011/65/EU, known as the RoHS initiative.

As of April 7, 2008, UL standards 506 and 1585 will be migrated to UL 5085-2 and 5085-3, respectively.

*Upon printing, this document is considered "uncontrolled". Please contact Triad Magnetics website for the most current version. For soldering and washing information please see <http://www.triadmagnetics.com/faq.html>

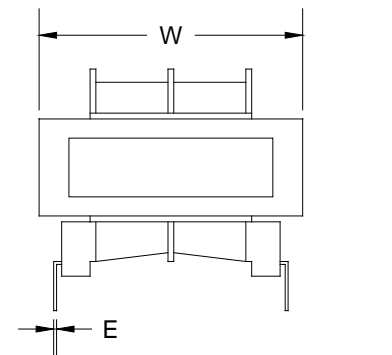

Board Layout

Mouser Electronics

Authorized Distributor

Click to View Pricing, Inventory, Delivery & Lifecycle Information:

[Triad Magnetics:](#)

[FS36-170](#)