

DESCRIPTION: FEMALE - DIP SOLDER / MACHINED - PREMIUM

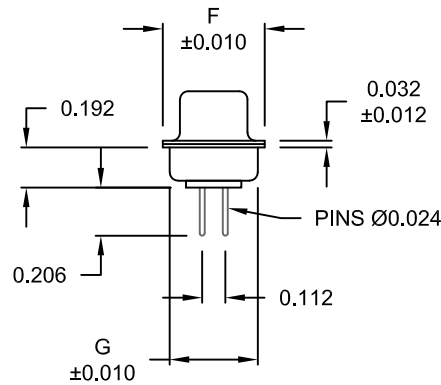
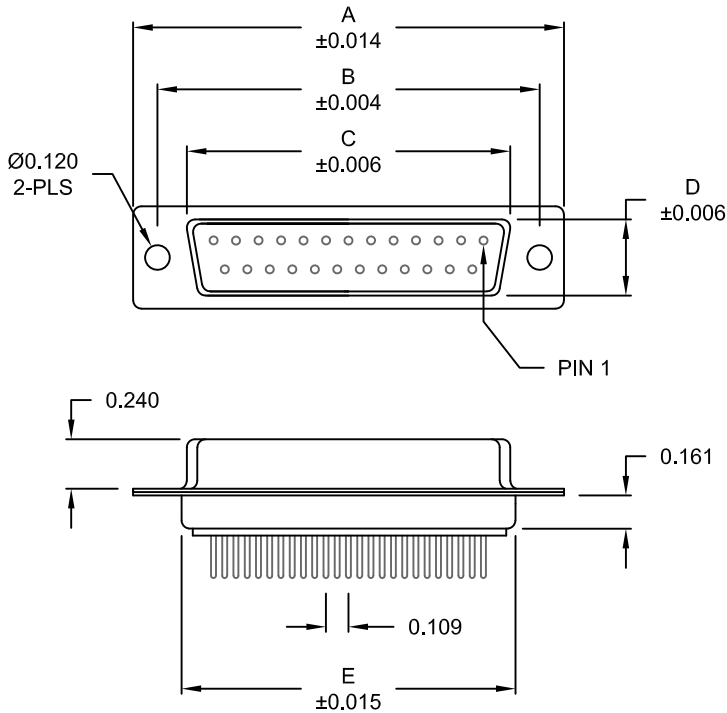

No. OF PINS	DIMENSIONS						
	A	B	C	D	E	F	G
9	1.213	0.984	0.642	0.315	0.760	0.496	0.429
	30.80	24.99	16.30	8.00	19.30	12.60	10.90
15	1.541	1.312	0.969	0.315	1.083	0.496	0.429
	39.15	33.32	24.60	8.00	27.51	12.60	10.90
25	2.088	1.852	1.512	0.315	1.630	0.496	0.429
	53.04	47.04	38.40	8.00	41.40	12.60	10.90
37	2.729	2.500	2.157	0.315	2.276	0.496	0.429
	69.32	63.50	54.80	8.00	57.81	12.60	10.90
50	2.635	2.406	2.059	0.425	2.182	0.598	0.535
	66.93	61.11	52.30	10.80	55.42	15.20	13.60

172-YYY-212RYY1

- SERIES _____
- POSITIONS _____
- 009 _____
- 015 _____
- 025 _____
- 037 _____
- 050 _____
- GENDER _____
- 2 = FEMALE
- TERMINATION _____
- 1 = DIP SOLDER
- SHELL PLATING _____
- 2 = TIN
- RoHS COMPLIANT _____
- HARDWARE OPTIONS _____
- 00 = NO HARDWARE
- 01 = .065" CLINCH NUT (BOARD SIDE)
- 02 = .250" CLINCH NUT (BOARD SIDE)
- 03 = .250" CLINCH NUT (MOUNTING SIDE)
- 05 = .237" 4-40 BOARD LOCK
- 90 = .237" 4-40 BOARD LOCK
- FOR 0.093" BOARD MAX.
- 91 = .237" 4-40 SPACER/ BOARD LOCK
- 92 = .237" 4-40 SPACER/ BOARD LOCK
- FOR 0.093" BOARD MAX.
- PLATING OPTIONS _____
- 1 = GOLD FLASH
- 2 = 30MICRO-INCH GOLD

MATERIAL:

- SHELL: STEEL, TIN
- INSULATOR: UL 94V-O RATED, PA6T
- PROCESS TEMP.: 260°C
- CONTACT: BRASS (FLOATING CONTACTS)

ELECTRICAL:

- CURRENT RATING: 5 AMPS
- CONTACT RESISTANCE: 15 mOhms Max.
- INSULATION RESISTANCE: 1,000 MOhms Min.
- VOLTAGE: 500VAC FOR 1 MINUTE
- TEMPERATURE: -50° C TO 100° C

DO NOT SCALE FROM DRAWING



THESE DRAWINGS AND SPECIFICATIONS ARE THE PROPERTY OF NorComp AND SHALL NOT BE REPRODUCED, COPIED OR USED AS THE BASIS FOR THE MANUFACTURE OF SALE OF APPARATUS WITHOUT WRITTEN PERMISSION.

DRAWN: PAM JENKINS		DATE: 09-12-05	
SCALE: NTS	SHEET 1	OF 3	REV 18
DWG NO. 172-YYY-212RYY1			

RoHS COMPLIANT

NorComp

DESCRIPTION: PCB LAYOUT - STANDARD "D" - MALE & FEMALE

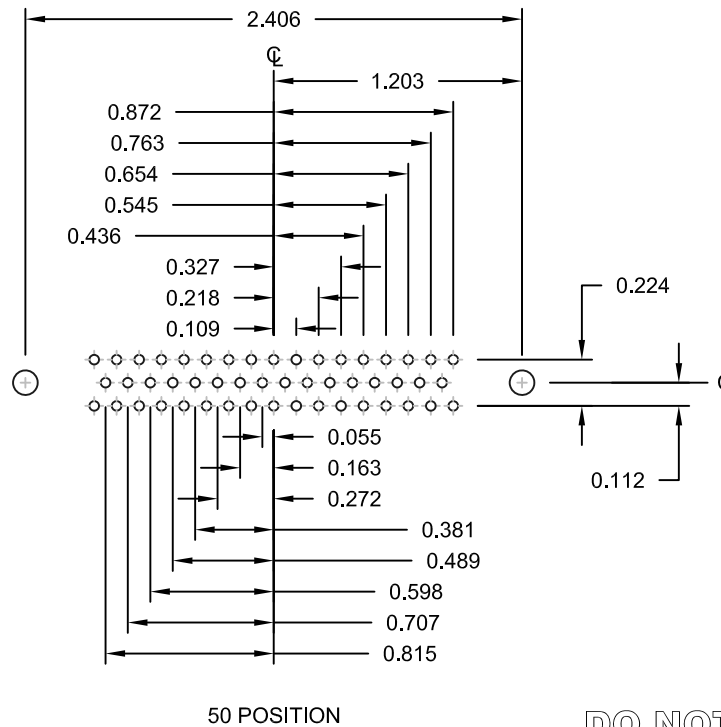
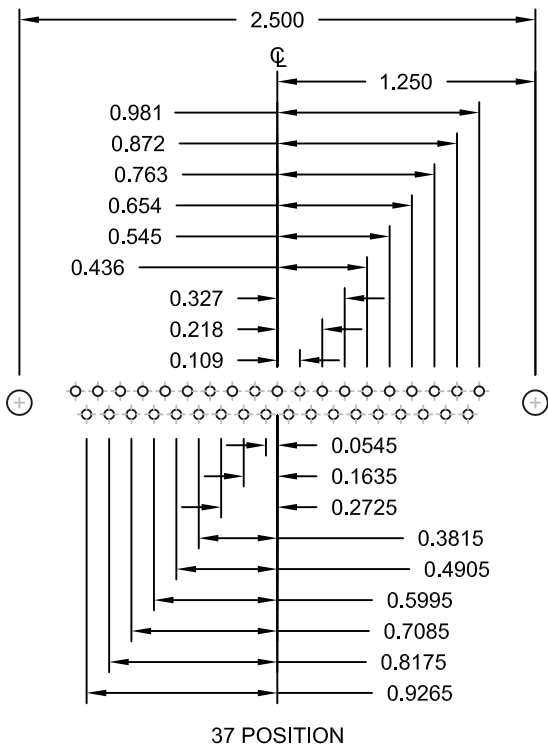
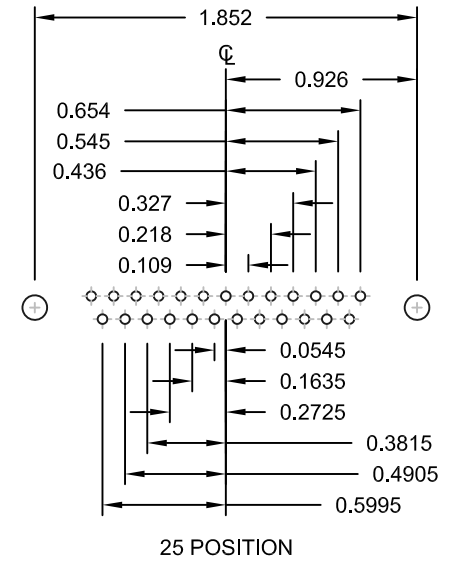
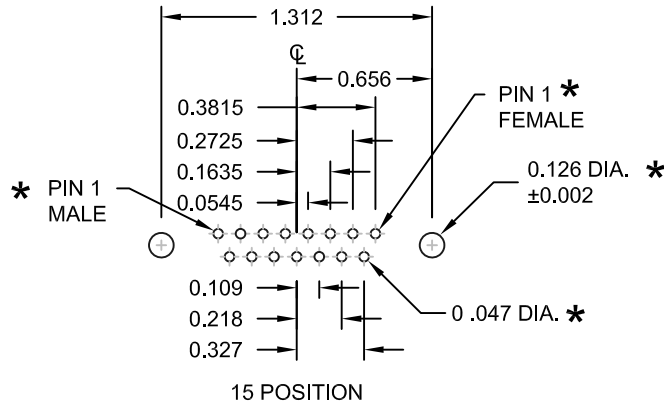
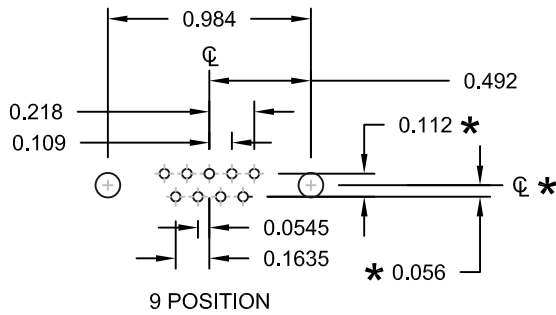

* TYP. ON ALL SIZES

DO NOT SCALE FROM DRAWING

	THESE DRAWINGS AND SPECIFICATIONS ARE THE PROPERTY OF NorComp AND SHALL NOT BE REPRODUCED, COPIED OR USED AS THE BASIS FOR THE MANUFACTURE OF SALE OF APPARATUS WITHOUT WRITTEN PERMISSION.		DRAWN: PAM JENKINS	DATE: 09-12-05
	NorComp		SCALE: NTS	SHEET 2 OF 3
DWG NO. 172-YYY-212RYY1				

DESCRIPTION: CLINCH NUT HARDWARE

ALL CLINCH-NUTS ARE 4-40 INTERNAL THREADS

TOLERANCE:
ALL DIMENSIONS ARE ±0.010

01X 0.065" (BOARD SIDE) - CN1

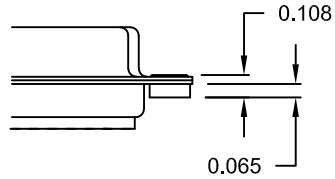

02X 0.250" (BOARD SIDE) - CN2

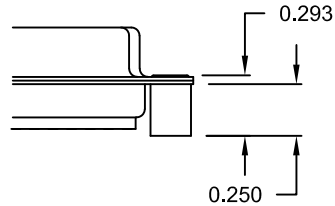

03X..... 0.250" (MATING SIDE) - CN8

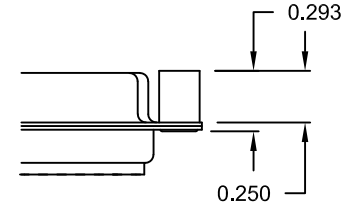

05X 0.237" (BOARD SIDE) - CN10

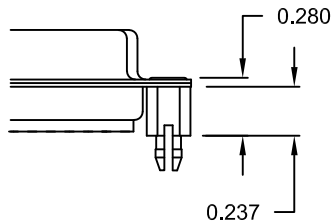

91X 0.237" (BOARD SIDE) - 0.197 MATING SIDE - CN10/SFISO4404

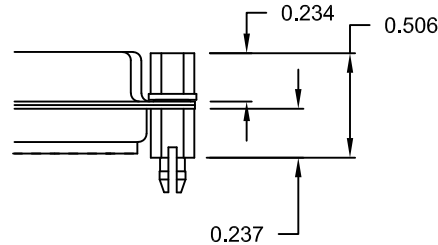

NOTE: 4-40 FEMALE SCREW LOCK IS REMOVABLE

90X 0.237" (BOARD SIDE) - CN10-237-093

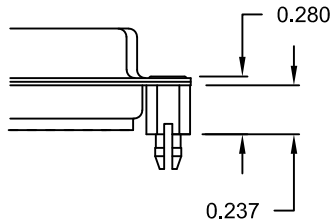

92X 0.237" BOARD SIDE
0.197 MATING SIDE
CN10-237-093/SFISO4404

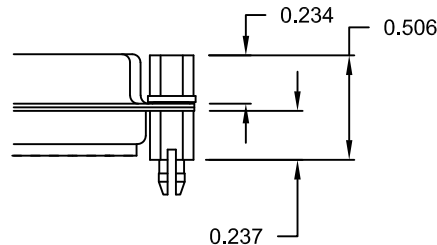

NOTE: 4-40 FEMALE SCREW LOCK IS REMOVABLE

NOTE: 90 & 92 OPTION FOR 0.093" MAX. BOARD THICKNESS

DO NOT SCALE FROM DRAWING



THESE DRAWINGS AND SPECIFICATIONS ARE THE PROPERTY OF NorComp AND SHALL NOT BE REPRODUCED, COPIED OR USED AS THE BASIS FOR THE MANUFACTURE OF SALE OF APPARATUS WITHOUT WRITTEN PERMISSION.

DRAWN: PAM JENKINS		DATE: 09-12-05	
SCALE: NTS	SHEET 3	OF 3	REV 18
DWG NO. 172-YYY-212RYY1			

RoHS COMPLIANT

NorComp

Mouser Electronics

Authorized Distributor

Click to View Pricing, Inventory, Delivery & Lifecycle Information:

NorComp:

[172-009-212R911](#) [172-015-212R911](#) [172-025-212R011](#) [172-025-212R911](#) [172-037-212R911](#) [172-050-212R011](#)
[172-050-212R911](#) [172-050-212R051](#) [172-025-212R051](#) [172-009-212R051](#) [172-015-212R051](#) [172-037-212R051](#)