

# F93 Series

## Resin-Molded Chip, Standard Tantalum J-Lead



### FEATURES

- Compliant to the RoHS3 directive 2015/863/EU
- SMD J-Lead
- 100% Surge Current Tested

### APPLICATIONS

- Low Power DC/DC



LEAD-FREE

LEAD-FREE COMPATIBLE COMPONENT



RoHS COMPLIANT

### CASE DIMENSIONS:

millimeters (inches)

Code	EIA Code	EIA Metric	L	W <sub>1</sub>	W <sub>2</sub>	H	S
A	1206	3216-18	3.20 ± 0.20 (0.126 ± 0.008)	1.60 ± 0.20 (0.063 ± 0.008)	1.20 ± 0.10 (0.047 ± 0.004)	1.60 ± 0.20 (0.063 ± 0.008)	0.80 ± 0.20 (0.031 ± 0.008)
B	1210	3528-21	3.50 ± 0.20 (0.138 ± 0.008)	2.80 ± 0.20 (0.110 ± 0.008)	2.20 ± 0.10 (0.087 ± 0.004)	1.90 ± 0.20 (0.075 ± 0.008)	0.80 ± 0.20 (0.031 ± 0.008)
C	2312	6032-27	6.00 ± 0.20 (0.236 ± 0.008)	3.20 ± 0.20 (0.126 ± 0.008)	2.20 ± 0.10 (0.087 ± 0.004)	2.50 ± 0.20 (0.098 ± 0.008)	1.30 ± 0.20 (0.051 ± 0.008)
N	2917	7343-30	7.30 ± 0.20 (0.287 ± 0.008)	4.30 ± 0.20 (0.169 ± 0.008)	2.40 ± 0.10 (0.094 ± 0.004)	2.80 ± 0.20 (0.110 ± 0.008)	1.30 ± 0.20 (0.051 ± 0.008)

#### A, B CASE

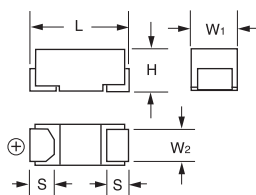

#### C, N CASE

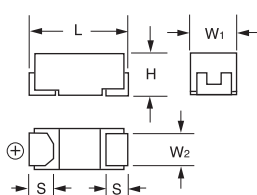

#### MARKING

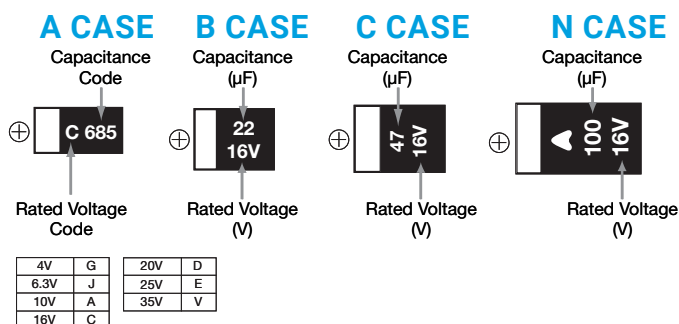

### HOW TO ORDER

**F93**

Type

**1A**

Rated Voltage

**106**

Capacitance Code  
pF code: 1st two digits represent significant figures, 3rd digit represents multiplier (number of zeros to follow)

**M**

Tolerance  
K = ±10%  
M = ±20%

**A**

Case Size  
See table above

**□**

Packaging  
See Tape & Reel Packaging Section

### TECHNICAL SPECIFICATIONS

Category Temperature Range:	-55 to +125°C
Rated Temperature:	+85°C
Capacitance Tolerance:	±20%, ±10% at 120Hz
Dissipation Factor:	Refer to next page
ESR 100kHz:	Refer to next page
Leakage Current:	After 1 minute's application of rated voltage, leakage current at 20°C is not more than 0.01CV or 0.5µA, whichever is greater. After 1 minute's application of rated voltage, leakage current at 85°C is not more than 0.1CV or 5µA, whichever is greater. After 1 minute's application of derated voltage, leakage current at 125°C is not more than 0.125CV or 6.3µA, whichever is greater.
Capacitance Change By Temperature	+15% Max. at +125°C +10% Max. at +85°C -10% Max. at -55°C

# F93 Series

## Resin-Molded Chip, Standard Tantalum J-Lead



### CAPACITANCE AND RATED VOLTAGE RANGE (LETTER DENOTES CASE SIZE)

Capacitance		Rated Voltage						
µF	Code	4V (0G)	6.3V (0J)	10V (1A)	16V (1C)	20V (1D)	25V (1E)	35V (1V)
0.33	334							A
0.47	474							A
0.68	684							A
1.0	105				A		A	A
1.5	155				A		A	A
2.2	225				A	A	A	A/B
3.3	335				A	A	A	B
4.7	475			A	A	A/B	A/B	B/C
6.8	685			A	A	A/B		C
10	106		A	A	A/B	A/B	B/C	C
15	156		A	A	A/B	C	C	N
22	226	A	A	A/B	A/B/C	B/C	C/N	N
33	336	A	A	A/B	B/C	C/N	N	N
47	476	A	A/B	A/B/C	B/C/N	C/N	N	
68	686	A	A/B	B/C	C/N			
100	107	A/B	A/B/C	B/C/N	C/N	N		
150	157	B	B/C	C/N	N			
220	227	B/C	B/C/N	C/N	N			
330	337	C	N	N				
470	477	N	N					
680	687	N	N					

Released ratings

Please contact to your local AVX sales office when these series are being designed in your application.

### RATINGS & PART NUMBER REFERENCE

AVX Part No.	Case Size	Capacitance (µF)	Rated Voltage (V)	DCL (µA)	DF @ 120Hz (%)	ESR @ 100kHz (Ω)	100kHz RMS Current (mA)			*1 ΔC/C (%)	MSL
							25°C	85°C	125°C		
<b>4 Volt</b>											
F930G226#AA	A	22	4	0.9	6	2.5	173	156	69	*	1
F930G336#AA	A	33	4	1.3	8	2.5	173	156	69	*	1
F930G476#AA	A	47	4	1.9	18	2.5	173	156	69	*	1
F930G686#AA	A	68	4	2.7	24	2.5	173	156	69	*	1
F930G107#AA	A	100	4	4.0	30	2.0	194	174	77	*	1
F930G107#BA	B	100	4	4.0	14	0.9	307	277	123	*	1
F930G157#BA	B	150	4	6.0	16	0.7	348	314	139	*	1
F930G227#BA	B	220	4	8.8	18	0.7	348	314	139	*	1
F930G227#CC	C	220	4	8.8	12	0.7	396	357	159	*	1
F930G337#CC	C	330	4	13.2	14	0.7	396	357	159	*	1
F930G477#NC	N	470	4	18.8	16	0.3	707	636	283	*	1
F930G687#NC	N	680	4	27.2	18	0.3	707	636	283	*	1
<b>6.3 Volt</b>											
F930J106#AA	A	10	6.3	0.6	6	3.0	158	142	63	*	1
F930J156#AA	A	15	6.3	0.9	6	2.9	161	145	64	*	1
F930J226#AA	A	22	6.3	1.4	8	2.5	173	156	69	*	1
F930J336#AA	A	33	6.3	2.1	8	2.5	173	156	69	*	1
F930J476#AA	A	47	6.3	3.0	18	2.5	173	156	69	*	1
F930J476#BA	B	47	6.3	3.0	6	1.0	292	262	117	*	1
F930J686#AA	A	68	6.3	4.3	20	2.0	194	174	77	*	1
F930J686#BA	B	68	6.3	4.3	8	1.0	292	262	117	*	1
F930J107#AA	A	100	6.3	6.3	35	2.0	194	174	77	±15	1
F930J107#BA	B	100	6.3	6.3	14	0.9	307	277	123	*	1
F930J107#CC	C	100	6.3	6.3	8	0.7	396	357	159	*	1
F930J157#BA	B	150	6.3	9.5	18	0.9	307	277	123	*	1
F930J157#CC	C	150	6.3	9.5	12	0.7	396	357	159	*	1
F930J227#BA	B	220	6.3	13.9	30	1.2	266	240	106	±15	3
F930J227#CC	C	220	6.3	13.9	14	0.7	396	357	159	*	1
F930J227#NC	N	220	6.3	13.9	10	0.5	548	493	219	*	1
F930J337#NC	N	330	6.3	20.8	14	0.5	548	493	219	*	1
F930J477#NC	N	470	6.3	29.6	16	0.3	707	636	283	*	1
F930J687#NC	N	680	6.3	42.8	40	0.3	707	636	283	±15	3
<b>10 Volt</b>											
F931A475#AA	A	4.7	10	0.5	6	4.0	137	123	55	*	1
F931A685#AA	A	6.8	10	0.7	6	3.5	146	132	59	*	1
F931A106#AA	A	10	10	1.0	6	3.0	158	142	63	*	1
F931A156#AA	A	15	10	1.5	8	2.9	161	145	64	*	1



The Important Information/Disclaimer is incorporated in the catalog where these specifications came from or available online at [www.avx.com/disclaimer/](http://www.avx.com/disclaimer/) by reference and should be reviewed in full before placing any order.

# F93 Series

## Resin-Molded Chip, Standard Tantalum J-Lead



### RATINGS & PART NUMBER REFERENCE

AVX Part No.	Case Size	Capacitance (µF)	Rated Voltage (V)	DCL (µA)	DF @ 120Hz (%)	ESR @ 100kHz (Ω)	100kHz RMS Current (mA)			*1 ΔC/C (%)	MSL
							25°C	85°C	125°C		
F931A226#AA	A	22	10	2.2	12	2.5	173	156	69	*	1
F931A226#BA	B	22	10	2.2	6	1.9	212	190	85	*	1
F931A336#AA	A	33	10	3.3	18	2.5	173	156	69	*	1
F931A336#BA	B	33	10	3.3	8	1.4	246	222	99	*	1
F931A476#AA	A	47	10	4.7	40	2.0	194	174	77	±15	1
F931A476#BA	B	47	10	4.7	8	1.0	292	262	117	*	1
F931A476#CC	C	47	10	4.7	6	0.9	350	315	140	*	1
F931A686#BA	B	68	10	6.8	12	0.9	307	277	123	±15	1
F931A686#CC	C	68	10	6.8	8	0.8	371	334	148	*	1
F931A107#BA	B	100	10	10.0	18	1.2	266	240	106	±15	1
F931A107#CC	C	100	10	10.0	10	0.7	396	357	159	*	1
F931A107#NC	N	100	10	10.0	8	0.6	500	450	200	*	3
F931A157#CC	C	150	10	15.0	14	0.7	396	357	159	*	1
F931A157#NC	N	150	10	15.0	10	0.6	500	450	200	*	1
F931A227#CC	C	220	10	22.0	40	0.9	350	315	140	±15	1
F931A227#NC	N	220	10	22.0	12	0.5	548	493	219	*	3
F931A337#NC	N	330	10	33.0	18	0.5	548	493	219	*	1
<b>16 Volt</b>											
F931C105#AA	A	1	16	0.5	4	7.5	100	90	40	*	1
F931C155#AA	A	1.5	16	0.5	4	6.0	112	101	45	*	1
F931C225#AA	A	2.2	16	0.5	4	5.0	122	110	49	*	1
F931C335#AA	A	3.3	16	0.5	4	4.5	129	116	52	*	1
F931C475#AA	A	4.7	16	0.8	6	4.0	137	123	55	*	1
F931C685#AA	A	6.8	16	1.1	6	3.5	146	132	59	*	1
F931C106#AA	A	10	16	1.6	6	3.0	158	142	63	*	1
F931C106#BA	B	10	16	1.6	6	2.0	206	186	82	*	1
F931C156#AA	A	15	16	2.4	10	3.0	158	142	63	*	1
F931C156#BA	B	15	16	2.4	6	2.0	206	186	82	*	1
F931C226#AA	A	22	16	3.5	15	3.0	158	142	63	±15	1
F931C226#BA	B	22	16	3.5	8	1.9	212	190	85	*	1
F931C226#CC	C	22	16	3.5	6	1.1	316	285	126	*	1
F931C336#BA	B	33	16	5.3	8	1.9	212	190	85	*	1
F931C336#CC	C	33	16	5.3	6	1.1	316	285	126	*	1
F931C476#BA	B	47	16	7.5	16	2.0	206	186	82	±15	1
F931C476#CC	C	47	16	7.5	8	0.9	350	315	140	*	1
F931C476#NC	N	47	16	7.5	6	0.7	463	417	185	*	1
F931C686#CC	C	68	16	10.9	10	0.8	371	334	148	±10	1
F931C686#NC	N	68	16	10.9	6	0.6	500	450	200	*	1
F931C107#CC	C	100	16	16.0	15	0.7	396	357	159	±10	1
F931C107#NC	N	100	16	16.0	10	0.6	500	450	200	*	3
F931C157#NC	N	150	16	24.0	15	0.6	500	450	200	*	1
F931C227#NC	N	220	16	35.2	25	0.7	463	417	185	±10	3
<b>20 Volt</b>											
F931D225#AA	A	2.2	20	0.5	4	5.0	122	110	49	*	1
F931D335#AA	A	3.3	20	0.7	4	4.5	129	116	52	*	1
F931D475#AA	A	4.7	20	0.9	6	3.0	158	142	63	*	1
F931D475#BA	B	4.7	20	0.9	6	2.8	174	157	70	*	1
F931D685#AA	A	6.8	20	1.4	6	3.5	146	132	59	*	1
F931D685#BA	B	6.8	20	1.4	6	2.5	184	166	74	*	1
F931D106#AA	A	10	20	2.0	8	3.5	146	132	59	*	1
F931D106#BA	B	10	20	2.0	6	2.1	201	181	80	*	1
F931D156#CC	C	15	20	3.0	6	1.2	303	272	121	*	1
F931D226#BA	B	22	20	4.4	8	1.9	212	190	85	*	1
F931D226#CC	C	22	20	4.4	8	1.1	316	285	126	*	1
F931D336#CC	C	33	20	6.6	8	1.1	316	285	126	*	1
F931D336#NC	N	33	20	6.6	6	0.7	463	417	185	*	1
F931D476#CC	C	47	20	9.4	10	1.1	316	285	126	*	1
F931D476#NC	N	47	20	9.4	8	0.7	463	417	185	*	1
F931D107#NC	N	100	20	20.0	12	0.5	548	493	219	±10	3
<b>25 Volt</b>											
F931E105#AA	A	1	25	0.5	4	7.5	100	90	40	*	1
F931E155#AA	A	1.5	25	0.5	4	6.7	106	95	42	*	1
F931E225#AA	A	2.2	25	0.6	6	6.3	109	98	44	*	1
F931E335#AA	A	3.3	25	0.8	6	6.0	112	101	45	*	1
F931E475#AA	A	4.7	25	1.2	8	4.0	137	123	55	*	1
F931E475#BA	B	4.7	25	1.2	6	2.8	174	157	70	*	1
F931E106#BA	B	10	25	2.5	12	1.9	212	190	85	*	1
F931E106#CC	C	10	25	2.5	6	1.5	271	244	108	*	1
F931E156#CC	C	15	25	3.8	8	1.2	303	272	121	*	1
F931E226#CC	C	22	25	5.5	8	1.1	316	285	126	*	1
F931E226#NC	N	22	25	5.5	6	0.7	463	417	185	*	1
F931E336#NC	N	33	25	8.3	8	0.7	463	417	185	*	1
F931E476#NC	N	47	25	11.8	8	0.7	463	417	185	*	1

# F93 Series

## Resin-Molded Chip, Standard Tantalum J-Lead

### RATINGS & PART NUMBER REFERENCE

AVX Part No.	Case Size	Capacitance (μF)	Rated Voltage (V)	DCL (μA)	DF @ 120Hz (%)	ESR @ 100kHz (Ω)	100kHz RMS Current (mA)			*1 ΔC/C (%)	MSL
							25°C	85°C	125°C		
F931E226#NC	N	22	25	5.5	6	0.7	463	417	185	*	1
F931E336#NC	N	33	25	8.3	8	0.7	463	417	185	*	1
F931E476#NC	N	47	25	11.8	8	0.7	463	417	185	*	1
<b>35 Volt</b>											
F931V334#AA	A	0.33	35	0.5	4	12.0	79	71	32	*	1
F931V474#AA	A	0.47	35	0.5	4	10.0	87	78	35	*	1
F931V684#AA	A	0.68	35	0.5	4	7.6	99	89	40	*	1
F931V105#AA	A	1	35	0.5	4	7.5	100	90	40	*	1
F931V155#AA	A	1.5	35	0.5	6	7.5	100	90	40	*	1
F931V225#AA	A	2.2	35	0.8	6	7.0	104	93	41	*	1
F931V225#BA	B	2.2	35	0.8	4	3.8	150	135	60	*	1
F931V335#BA	B	3.3	35	1.2	4	3.5	156	140	62	*	1
F931V475#BA	B	4.7	35	1.6	8	3.1	166	149	66	*	1
F931V475#CC	C	4.7	35	1.6	6	1.8	247	222	99	*	1
F931V685#CC	C	6.8	35	2.4	6	1.8	247	222	99	*	1
F931V106#CC	C	10	35	3.5	6	1.6	262	236	105	*	1
F931V156#NC	N	15	35	5.3	6	0.7	463	417	185	*	1
F931V226#NC	N	22	35	7.7	8	0.7	463	417	185	*	1
F931V336#NC	N	33	35	11.6	8	0.7	463	417	185	*	1

\*1: ΔC/C Marked "\*\*"

#: "M" for ±20% tolerance, "K" for ±10% tolerance.  
Moisture Sensitivity Level (MSL) is defined according to J-STD-020.

Item	All Case (%)
Damp Heat	±10
Temperature cycles	±5
Resistance soldering heat	±5
Surge	±5
Endurance	±10

### QUALIFICATION TABLE

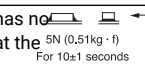
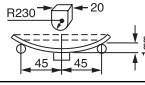
TEST	F93 series (Temperature range -55°C to +125°C)	
	Condition	
<b>Damp Heat (Steady State)</b>	At 40°C, 90 to 95% R.H., 500 hours (No voltage applied) Capacitance Change ..... Refer to page 33 (*1) Dissipation Factor ..... Initial specified value or less Leakage Current ..... Initial specified value or less	
<b>Temperature Cycles</b>	-55°C / +125°C, 30 minutes each, 5 cycles Capacitance Change ..... Refer to page 33 (*1) Dissipation Factor ..... Initial specified value or less Leakage Current ..... Initial specified value or less	
<b>Resistance to Soldering Heat</b>	10 seconds reflow at 260°C, 5 seconds immersion at 260°C. Capacitance Change ..... Refer to page 33 (*1) Dissipation Factor ..... Initial specified value or less Leakage Current ..... Initial specified value or less	
<b>Surge</b>	After application of surge voltage in series with a 33Ω resistor at the rate of 30 seconds ON, 30 seconds OFF, for 1000 successive test cycles at 85°C, capacitors shall meet the characteristic requirements in the table above. Capacitance Change Refer to page 33 (*1) Dissipation Factor ..... Initial specified value or less Leakage Current ..... Initial specified value or less	
<b>Endurance</b>	After 2000 hours' application of rated voltage in series with a 3Ω resistor at 85°C, or derated voltage in series with a 3Ω resistor at 125°C, capacitors shall meet the characteristic requirements in the table above. Capacitance Change ..... Refer to page 33 (*1) Dissipation Factor ..... Initial specified value or less Leakage Current ..... Initial specified value or less	
<b>Shear Test</b>	After applying the pressure load of 5N for 10±1 seconds horizontally to the center of capacitor side body which has no electrode and has been soldered beforehand on a substrate, there shall be found neither exfoliation nor its sign at the terminal electrode. 	
<b>Terminal Strength</b>	Keeping a capacitor surface-mounted on a substrate upside down and supporting the substrate at both of the opposite bottom points 45mm apart from the center of capacitor, the pressure strength is applied with a specified jig at the center of substrate so that the substrate may bend by 1mm as illustrated. Then, there shall be found no remarkable abnormality on the capacitor terminals. 	
<b>Failure Rate</b>	1% per 1000 hours at 85°C, V <sub>R</sub> with 0.1Ω/V series impedance, 60% confidence level.	

We can supply the type of compliance to AEC-Q200. Please contact to your local AVX sales office when these series are being designed in your application.

# F93 Series

## Resin-Molded Chip, Standard Tantalum J-Lead



### AVX SOLID ELECTROLYTIC CAPACITOR ROADMAP

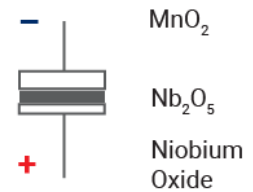
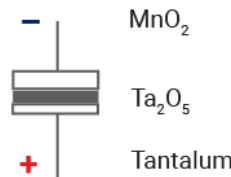
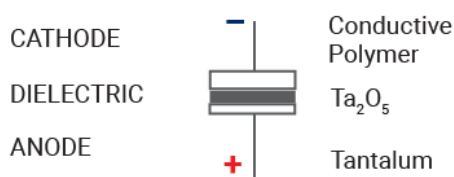
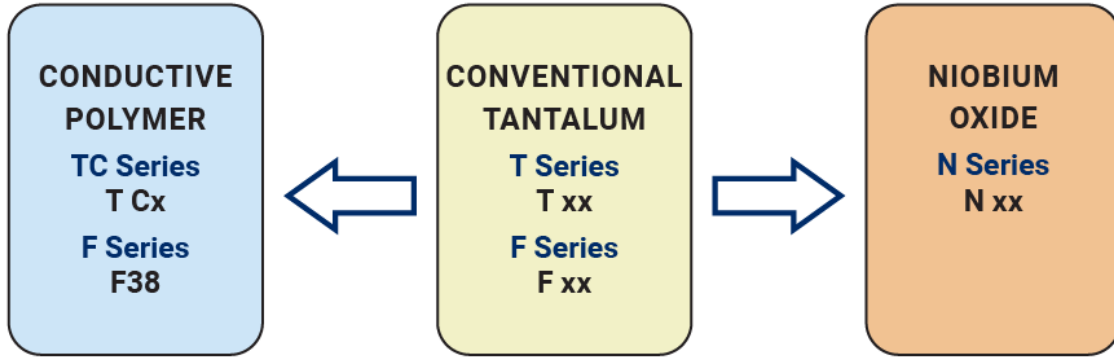

### FIVE CAPACITOR CONSTRUCTION STYLES

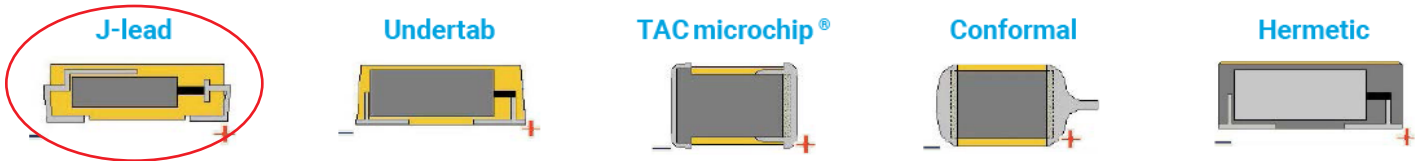

### SERIES LINE UP: CONVENTIONAL SMD MnO<sub>2</sub>

