

VDR Metal Oxide Varistors Standard



ADDITIONAL RESOURCES



3D Models



Design Tools



Models

| QUICK REFERENCE DATA | | |
|---|---|------|
| PARAMETER | VALUE | UNIT |
| Maximum continuous voltage in operating temperature range: | | |
| RMS | 14 to 680 | V |
| DC | 18 to 895 | V |
| Maximum non-repetitive transient current I_{NRP} (8 x 20 μ s) | 100 to 6500 | A |
| Maximum energy (10/1000 μ s) | 0.5 to 496 | J |
| Detailed specification | Based on IEC 61051-1 IEC 61051-2 IEC 61051-2-2 | |
| Storage temperature | -40 to +125 | °C |
| Operating temperature | -40 to +85 | °C |

ORDERING INFORMATION

The varistors are available in a number of packaging options:

- Bulk
- On tape and reel
- On tape in ammpack (fanfold)

The basic ordering code for each option is given in tables titled Varistors on Tape on Reel, Varistors on Tape in Ammpack and Varistors in Bulk. To complete the catalog number and to determine the required operating parameters, see Electrical Data and Ordering Information table.

Note

- Special lead-configuration as inside or outside crimped leads on request

AGENCY APPROVALS

- cUL certificate
- ULus certificate
- VDE certificate

Note

- Agency approval documents, please see: www.vishay.com/varistors/list/product-29081/tab/documents/

FEATURES

- Low β high purity zinc oxide disc
- Halogen free insulating epoxy coating
- Straight leads and kinked leads
- Straight leads with flange (VDRS05 and VDRS07 only)
- Certified for operation up to 85 °C according to UL 1449 edition 4, VDE/IEC 61051-1/2
- Material categorization: for definitions of compliance please see www.vishay.com/doc?99912

RoHS
COMPLIANT
HALOGEN
FREE

APPLICATION

- Overvoltage and transient voltage protection

DESCRIPTION

The varistors consist of a disc of low- β ZnO ceramic material with two solid copper leads (S20 types only) or copper clad steel wire. The wires have a matte tin plating. They are coated with UL 94 V-0 approved ochre colored halogen-free epoxy, which provides electrical, mechanical and climatic protection.

MOUNTING

The varistors are suitable for hand-mounting (bulk) or automatic pick and place mounting (tape on reel or fanfold). The parts can be soldered by hand or wave soldering. Pin-in-paste reflow soldering is not recommended. Bending of the leads for different angle placement is not recommended.

Typical soldering

235 °C, duration: 5 s (Pb-bearing)

245 °C, duration: 5 s (lead (Pb)-free)

Resistance to soldering heat

260 °C, duration: 10 s max.

MARKING

The varistors are marked with the following information:

- Maximum continuous RMS voltage
- Series numbers
 - 592 for VDRS05
 - 593 for VDRS07
 - 594 for VDRS10
 - 595 for VDRS14
 - 596 for VDRS20
- Safety marks on VDRS10-14-20 types
- Manufacturers logo
- Date of manufacture (YYWW)

INFLAMMABILITY

The varistors are passive non-flammable.

The encapsulation is made of flammable resistant epoxy in accordance with UL 94 V-0.



ELECTRICAL DATA AND ORDERING INFORMATION

| MAXIMUM CONTINUOUS VOLTAGE | | VOLTAGE AT 1 mA ⁽³⁾ | MAXIMUM VOLTAGE AT STATED CURRENT | | MAXIMUM ENERGY ⁽⁴⁾ (10 x 1000 µs) | MAXIMUM NON-REP. TRANSIENT CURRENT ⁽⁵⁾ I _{NRP} (8 x 20 µs) | NOMINAL DISCHARGE CURRENT ⁽⁷⁾ I _N | TYPICAL CAPACITANCE AT 1 kHz | T (max.) | E | SAP MATERIAL AND ORDERING NUMBER ⁽¹⁾ xy ⁽⁶⁾ |
|----------------------------|-----------|--------------------------------|-----------------------------------|----------|---|---|--|------------------------------|----------|-----------|--|
| RMS ⁽²⁾ (V) | DC (V) | (V) | V (V) | I (A) | (J) | (A) | (kA) | (pF) | (mm) | (mm) | |
| 14 | 18 | 22 | 48 | 1.0 | 0.5 | 100 | 0.10 | 1300 | 4.1 | 0.7 ± 0.3 | VDRS05A014xyE |
| | | | 43 | 2.5 | 1.7 | 250 | 0.15 | 2800 | 4.1 | 0.7 ± 0.3 | VDRS07B014xyE |
| | | | 43 | 5.0 | 4.3 | 500 | 0.25 | 6000 | 4.4 | 0.9 ± 0.3 | VDRS10D014xyE |
| | | | 43 | 10.0 | 5.4 | 1000 | 1.00 | 15 000 | 4.4 | 0.9 ± 0.3 | VDRS14G014xyE |
| | | | 43 | 20.0 | 8.0 | 2000 | 2.00 | 30 000 | 4.6 | 1.1 ± 0.3 | VDRS20M014ByE |
| 17 | 22 | 27 | 60 | 1.0 | 0.7 | 100 | 0.10 | 1050 | 4.1 | 0.8 ± 0.3 | VDRS05A017xyE |
| | | | 53 | 2.5 | 2.0 | 250 | 0.15 | 2000 | 4.1 | 0.8 ± 0.3 | VDRS07B017xyE |
| | | | 53 | 5.0 | 5.3 | 500 | 0.25 | 4000 | 4.4 | 1.0 ± 0.3 | VDRS10D017xyE |
| | | | 53 | 10.0 | 6.9 | 1000 | 1.00 | 10 000 | 4.4 | 1.0 ± 0.3 | VDRS14G017xyE |
| | | | 53 | 20.0 | 10.0 | 2000 | 2.00 | 20 000 | 4.6 | 1.2 ± 0.3 | VDRS20M017ByE |
| 20 | 26 | 33 | 73 | 1.0 | 0.8 | 100 | 0.10 | 900 | 4.1 | 1.0 ± 0.3 | VDRS05A020xyE |
| | | | 65 | 2.5 | 2.5 | 250 | 0.15 | 1500 | 4.1 | 1.0 ± 0.3 | VDRS07B020xyE |
| | | | 65 | 5.0 | 6.5 | 500 | 0.25 | 3000 | 4.4 | 1.2 ± 0.3 | VDRS10D020xyE |
| | | | 65 | 10.0 | 8.8 | 1000 | 1.00 | 7500 | 4.4 | 1.2 ± 0.3 | VDRS14G020xyE |
| | | | 65 | 20.0 | 12.0 | 2000 | 2.00 | 15 000 | 4.8 | 1.4 ± 0.3 | VDRS20M020ByE |
| 25 | 31 | 39 | 86 | 1.0 | 0.9 | 100 | 0.10 | 500 | 4.2 | 1.2 ± 0.3 | VDRS05A025xyE |
| | | | 77 | 2.5 | 3.0 | 250 | 0.15 | 1350 | 4.2 | 1.2 ± 0.3 | VDRS07B025xyE |
| | | | 77 | 5.0 | 7.7 | 500 | 0.25 | 2600 | 4.6 | 1.4 ± 0.3 | VDRS10D025xyE |
| | | | 77 | 10.0 | 9.4 | 1000 | 1.00 | 6500 | 4.6 | 1.4 ± 0.3 | VDRS14G025xyE |
| | | | 77 | 20.0 | 14.0 | 2000 | 2.00 | 13 000 | 5.0 | 1.6 ± 0.3 | VDRS20M025ByE |
| 30 | 38 | 47 | 96 | 1.0 | 1.1 | 100 | 0.10 | 700 | 4.4 | 1.4 ± 0.5 | VDRS05A030xyE |
| | | | 93 | 2.5 | 3.6 | 250 | 0.15 | 1600 | 4.4 | 1.4 ± 0.5 | VDRS07B030xyE |
| | | | 93 | 5.0 | 9.2 | 500 | 0.25 | 2700 | 4.8 | 1.6 ± 0.5 | VDRS10D030xyE |
| | | | 93 | 10.0 | 12.0 | 1000 | 1.00 | 6000 | 4.8 | 1.6 ± 0.5 | VDRS14G030xyE |
| | | | 93 | 20.0 | 17.0 | 2000 | 2.00 | 12 000 | 5.2 | 1.8 ± 0.5 | VDRS20M030ByE |
| 35 | 45 | 56 | 123 | 1.0 | 1.4 | 100 | 0.10 | 560 | 4.8 | 1.7 ± 0.5 | VDRS05A035xyE |
| | | | 110 | 2.5 | 4.4 | 250 | 0.15 | 1300 | 4.8 | 1.7 ± 0.5 | VDRS07B035xyE |
| | | | 110 | 5.0 | 11.0 | 500 | 0.25 | 2200 | 5.2 | 1.9 ± 0.5 | VDRS10D035xyE |
| | | | 110 | 10.0 | 14.0 | 1000 | 1.00 | 4800 | 5.2 | 1.9 ± 0.5 | VDRS14G035xyE |
| | | | 110 | 20.0 | 20.0 | 2000 | 2.00 | 9600 | 5.6 | 2.1 ± 0.5 | VDRS20M035ByE |
| 40 | 56 | 68 | 145 | 1.0 | 1.6 | 100 | 0.10 | 460 | 5.1 | 2.1 ± 0.5 | VDRS05A040xyE |
| | | | 135 | 2.5 | 5.2 | 250 | 0.15 | 1000 | 5.1 | 2.1 ± 0.5 | VDRS07B040xyE |
| | | | 135 | 5.0 | 13.0 | 500 | 0.25 | 1800 | 5.5 | 2.3 ± 0.5 | VDRS10D040xyE |
| | | | 135 | 10.0 | 17.0 | 1000 | 1.00 | 3800 | 5.5 | 2.3 ± 0.5 | VDRS14G040xyE |
| | | | 135 | 20.0 | 24.0 | 2000 | 2.00 | 7600 | 5.9 | 2.5 ± 0.5 | VDRS20M040ByE |
| 50 | 65 | 82 | 145 | 5.0 | 2.6 | 400 | 0.10 | 370 | 4.1 | 0.6 ± 0.3 | VDRS05C050xyE |
| | | | 140 | 10.0 | 7.0 | 1200 | 0.50 | 900 | 4.1 | 0.6 ± 0.3 | VDRS07H050xyE |
| | | | 140 | 25.0 | 12.0 | 2500 | 1.50 | 1500 | 4.4 | 0.8 ± 0.3 | VDRS10P050xyE |
| | | | 140 | 50.0 | 21.0 | 4500 | 3.00 | 3100 | 4.4 | 0.8 ± 0.3 | VDRS14T050xyE |
| | | | 170 | 5.0 | 2.9 | 400 | 0.10 | 290 | 4.1 | 0.7 ± 0.3 | VDRS05C060xyE |
| 60 | 85 | 100 | 165 | 10.0 | 8.3 | 1200 | 0.50 | 700 | 4.1 | 0.7 ± 0.3 | VDRS07H060xyE |
| | | | 165 | 25.0 | 15.0 | 2500 | 1.50 | 1200 | 4.4 | 0.9 ± 0.3 | VDRS10P060xyE |
| | | | 165 | 50.0 | 24.0 | 4500 | 3.00 | 2300 | 4.4 | 0.9 ± 0.3 | VDRS14T060xyE |
| | | | 165 | 100.0 | 56.0 | 6500 | 3.00 | 4700 | 4.5 | 1.1 ± 0.3 | VDRS20W060ByE |
| | | | 210 | 5.0 | 3.4 | 400 | 0.10 | 240 | 4.1 | 0.9 ± 0.3 | VDRS05C075xyE |
| 75 | 100 | 120 | 200 | 10.0 | 10.0 | 1200 | 0.50 | 530 | 4.1 | 0.9 ± 0.3 | VDRS07H075xyE |
| | | | 200 | 25.0 | 18.0 | 2500 | 1.50 | 1000 | 4.4 | 1.1 ± 0.3 | VDRS10P075xyE |
| | | | 200 | 50.0 | 29.0 | 4500 | 3.00 | 1900 | 4.4 | 1.1 ± 0.3 | VDRS14T075xyE |
| | | | 200 | 100.0 | 64.0 | 6500 | 3.00 | 3900 | 4.8 | 1.3 ± 0.3 | VDRS20W075ByE |
| | | | 250 | 5.0 | 4.1 | 400 | 0.10 | 180 | 4.2 | 1.1 ± 0.3 | VDRS05C095xyE |
| 95 | 125 | 150 | 250 | 10.0 | 13.0 | 1200 | 0.50 | 450 | 4.2 | 1.1 ± 0.3 | VDRS07H095xyE |
| | | | 250 | 25.0 | 22.0 | 2500 | 1.50 | 800 | 4.6 | 1.3 ± 0.3 | VDRS10P095xyE |
| | | | 250 | 50.0 | 37.0 | 4500 | 3.00 | 1500 | 4.6 | 1.3 ± 0.3 | VDRS14T095xyE |
| | | | 250 | 100.0 | 88.0 | 6500 | 3.00 | 3000 | 5.2 | 1.5 ± 0.3 | VDRS20W095ByE |



| ELECTRICAL DATA AND ORDERING INFORMATION | | | | | | | | | | | |
|--|--------|--------------------------------|-----------------------------------|-------|--|--|---|------------------------------|----------|-----------|---|
| MAXIMUM CONTINUOUS VOLTAGE | | VOLTAGE ⁽³⁾ AT 1 mA | MAXIMUM VOLTAGE AT STATED CURRENT | | MAXIMUM ENERGY ⁽⁴⁾ (10 x 1000 µs) | MAXIMUM NON-REP. TRANSIENT CURRENT ⁽⁵⁾ I _{NRP} (8 x 20 µs) | NOMINAL DISCHARGE CURRENT ⁽⁷⁾ I _N | TYPICAL CAPACITANCE AT 1 kHz | T (max.) | E | SAP MATERIAL AND ORDERING NUMBER ⁽¹⁾ xy ⁽⁶⁾ |
| RMS ⁽²⁾ (V) | DC (V) | (V) | V (V) | I (A) | (J) | (A) | (kA) | (pF) | (mm) | (mm) | |
| 130 | 170 | 205 | 345 | 5.0 | 5.5 | 400 | 0.10 | 130 | 4.2 | 1.0 ± 0.3 | VDRS05C130xyE |
| | | | 340 | 10.0 | 17.0 | 1200 | 0.50 | 320 | 4.2 | 1.0 ± 0.3 | VDRS07H130xyE |
| | | | 340 | 25.0 | 30.0 | 2500 | 1.50 | 580 | 4.6 | 1.2 ± 0.3 | VDRS10P130xyE |
| | | | 340 | 50.0 | 56.0 | 4500 | 3.00 | 1050 | 4.6 | 1.2 ± 0.3 | VDRS14T130xyE |
| | | | 340 | 100.0 | 114.0 | 6500 | 3.00 | 2100 | 5.3 | 1.4 ± 0.3 | VDRS20W130ByE |
| 140 | 180 | 220 | 380 | 5.0 | 6.3 | 400 | 0.10 | 120 | 4.4 | 1.0 ± 0.3 | VDRS05C140xyE |
| | | | 360 | 10.0 | 21.0 | 1200 | 0.50 | 290 | 4.4 | 1.0 ± 0.3 | VDRS07H140xyE |
| | | | 360 | 25.0 | 33.0 | 2500 | 1.50 | 540 | 4.8 | 1.2 ± 0.3 | VDRS10P140xyE |
| | | | 360 | 50.0 | 57.0 | 4500 | 3.00 | 950 | 4.8 | 1.2 ± 0.3 | VDRS14T140xyE |
| | | | 360 | 100.0 | 124.0 | 6500 | 3.00 | 1900 | 5.4 | 1.5 ± 0.3 | VDRS20W140ByE |
| 150 | 200 | 240 | 400 | 5.0 | 7.1 | 400 | 0.10 | 110 | 4.4 | 1.1 ± 0.3 | VDRS05C150xyE |
| | | | 395 | 10.0 | 20.0 | 1200 | 0.50 | 270 | 4.4 | 1.1 ± 0.3 | VDRS07H150xyE |
| | | | 395 | 25.0 | 36.0 | 2500 | 1.50 | 490 | 4.8 | 1.3 ± 0.3 | VDRS10P150xyE |
| | | | 395 | 50.0 | 59.0 | 4500 | 3.00 | 850 | 4.8 | 1.3 ± 0.3 | VDRS14T150xyE |
| | | | 395 | 100.0 | 134.0 | 6500 | 3.00 | 1700 | 5.5 | 1.6 ± 0.3 | VDRS20W150ByE |
| 175 | 225 | 275 | 455 | 5.0 | 7.3 | 400 | 0.10 | 90 | 4.6 | 1.3 ± 0.3 | VDRS05C175xyE |
| | | | 455 | 10.0 | 23.0 | 1200 | 0.50 | 230 | 4.6 | 1.3 ± 0.3 | VDRS07H175xyE |
| | | | 455 | 25.0 | 41.0 | 2500 | 1.50 | 430 | 5.0 | 1.5 ± 0.3 | VDRS10P175xyE |
| | | | 455 | 50.0 | 67.0 | 4500 | 3.00 | 750 | 5.0 | 1.5 ± 0.3 | VDRS14T175xyE |
| | | | 455 | 100.0 | 158.0 | 6500 | 3.00 | 1500 | 5.7 | 1.7 ± 0.3 | VDRS20W175ByE |
| 230 | 300 | 360 | 600 | 5.0 | 10.0 | 400 | 0.10 | 70 | 4.9 | 1.7 ± 0.8 | VDRS05C230xyE |
| | | | 595 | 10.0 | 30.0 | 1200 | 0.50 | 170 | 4.9 | 1.7 ± 0.8 | VDRS07H230xyE |
| | | | 595 | 25.0 | 54.0 | 2500 | 1.50 | 320 | 5.4 | 1.9 ± 0.8 | VDRS10P230xyE |
| | | | 595 | 50.0 | 88.0 | 4500 | 3.00 | 540 | 5.4 | 1.9 ± 0.8 | VDRS14T230xyE |
| | | | 595 | 100.0 | 208.0 | 6500 | 3.00 | 1100 | 6.2 | 2.2 ± 0.8 | VDRS20W230ByE |
| 250 | 320 | 390 | 650 | 5.0 | 11.0 | 400 | 0.10 | 60 | 4.9 | 1.9 ± 0.8 | VDRS05C250xyE |
| | | | 650 | 10.0 | 33.0 | 1200 | 0.50 | 160 | 4.9 | 1.9 ± 0.8 | VDRS07H250xyE |
| | | | 650 | 25.0 | 58.0 | 2500 | 1.50 | 300 | 5.4 | 2.1 ± 0.8 | VDRS10P250xyE |
| | | | 650 | 50.0 | 96.0 | 4500 | 3.00 | 480 | 5.4 | 2.1 ± 0.8 | VDRS14T250xyE |
| | | | 650 | 100.0 | 240.0 | 6500 | 3.00 | 960 | 6.4 | 2.3 ± 0.8 | VDRS20W250ByE |
| 275 | 350 | 430 | 710 | 5.0 | 12.0 | 400 | 0.10 | 55 | 4.9 | 2.0 ± 0.8 | VDRS05C275xyE |
| | | | 710 | 10.0 | 36.0 | 1200 | 0.50 | 140 | 4.9 | 2.0 ± 0.8 | VDRS07H275xyE |
| | | | 710 | 25.0 | 63.0 | 2500 | 1.50 | 270 | 5.4 | 2.2 ± 0.8 | VDRS10P275xyE |
| | | | 710 | 50.0 | 104.0 | 4500 | 3.00 | 440 | 5.4 | 2.2 ± 0.8 | VDRS14T275xyE |
| | | | 710 | 100.0 | 264.0 | 6500 | 3.00 | 900 | 6.6 | 2.5 ± 0.8 | VDRS20W275ByE |
| 300 | 385 | 470 | 800 | 5.0 | 13.0 | 400 | 0.10 | 50 | 5.3 | 2.2 ± 0.8 | VDRS05C300xyE |
| | | | 775 | 10.0 | 40.0 | 1200 | 0.50 | 130 | 5.3 | 2.2 ± 0.8 | VDRS07H300xyE |
| | | | 775 | 25.0 | 71.0 | 2500 | 1.50 | 240 | 5.9 | 2.4 ± 0.8 | VDRS10P300xyE |
| | | | 775 | 50.0 | 117.0 | 4500 | 3.00 | 400 | 5.9 | 2.4 ± 0.8 | VDRS14T300xyE |
| | | | 775 | 100.0 | 280.0 | 6500 | 3.00 | 810 | 6.9 | 2.7 ± 0.8 | VDRS20W300ByE |
| 320 | 420 | 510 | 850 | 5.0 | 15.0 | 400 | 0.10 | 45 | 5.5 | 2.4 ± 0.8 | VDRS05C320xyE |
| | | | 842 | 10.0 | 44.0 | 1200 | 0.50 | 120 | 5.5 | 2.4 ± 0.8 | VDRS07H320xyE |
| | | | 842 | 25.0 | 77.0 | 2500 | 1.50 | 220 | 6.2 | 2.6 ± 0.8 | VDRS10P320xyE |
| | | | 842 | 50.0 | 120.0 | 4500 | 3.00 | 370 | 6.2 | 2.6 ± 0.8 | VDRS14T320xyE |
| | | | 842 | 100.0 | 296.0 | 6500 | 3.00 | 750 | 7.1 | 2.9 ± 0.8 | VDRS20W320ByE |
| 350 | 460 | 560 | 940 | 5.0 | 19.5 | 400 | 0.10 | 42 | 5.8 | 2.7 ± 0.8 | VDRS05C350xyE |
| | | | 920 | 10.0 | 39.0 | 1200 | 0.50 | 110 | 5.8 | 2.7 ± 0.8 | VDRS07H350xyE |
| | | | 920 | 25.0 | 78.0 | 2500 | 1.50 | 200 | 6.6 | 2.9 ± 0.8 | VDRS10P350xyE |
| | | | 920 | 50.0 | 156.0 | 4500 | 3.00 | 325 | 6.6 | 2.9 ± 0.8 | VDRS14T350xyE |
| | | | 920 | 100.0 | 312.0 | 6500 | 3.00 | 660 | 7.4 | 3.2 ± 0.8 | VDRS20W350ByE |
| 385 | 505 | 620 | 1025 | 5.0 | 18.0 | 400 | 0.10 | 40 | 6.0 | 3.0 ± 0.8 | VDRS05C385xyE |
| | | | 1025 | 10.0 | 51.0 | 1200 | 0.50 | 95 | 6.0 | 3.0 ± 0.8 | VDRS07H385xyE |
| | | | 1025 | 25.0 | 67.0 | 2500 | 1.50 | 180 | 6.6 | 3.2 ± 0.8 | VDRS10P385xyE |
| | | | 1025 | 50.0 | 110.0 | 4500 | 3.00 | 280 | 6.6 | 3.2 ± 0.8 | VDRS14T385xyE |
| | | | 1025 | 100.0 | 328.0 | 6500 | 3.00 | 570 | 7.7 | 3.5 ± 0.8 | VDRS20W385ByE |



| ELECTRICAL DATA AND ORDERING INFORMATION | | | | | | | | | | | |
|--|-----------------------------------|---|----------|--|--|--|------------------------------------|-------------|------|--|---------------|
| MAXIMUM CONTINUOUS VOLTAGE | VOLTAGE ⁽³⁾ AT 1 mA | MAXIMUM VOLTAGE AT STATED CURRENT | | MAXIMUM ENERGY ⁽⁴⁾ (10 x 1000 µs) | MAXIMUM NON-REP. TRANSIENT CURRENT ⁽⁵⁾ I _{NRP} (8 x 20 µs) | NOMINAL DISCHARGE CURRENT ⁽⁷⁾ I _N | TYPICAL CAPACITANCE AT 1 kHz | T (max.) | E | SAP MATERIAL AND ORDERING NUMBER ⁽¹⁾ xy ⁽⁶⁾ | |
| | | V (V) | I (A) | | | | | | | | (J) |
| 420 | 560 | 680 | 1120 | 5.0 | 20.0 | 400 | 0.10 | 35 | 6.1 | 3.2 ± 0.8 | VDRS05C420xyE |
| | | | 1120 | 10.0 | 56.0 | 1200 | 0.50 | 85 | 6.1 | 3.2 ± 0.8 | VDRS07H420xyE |
| | | | 1120 | 25.0 | 73.0 | 2500 | 1.50 | 165 | 6.6 | 3.4 ± 0.8 | VDRS10P420xyE |
| | | | 1120 | 50.0 | 120.0 | 4500 | 3.00 | 250 | 6.6 | 3.4 ± 0.8 | VDRS14T420xyE |
| | | | 1120 | 100.0 | 344.0 | 6500 | 3.00 | 510 | 8.1 | 3.7 ± 0.8 | VDRS20W420ByE |
| 460 | 615 | 750 | 1240 | 5.0 | 21.0 | 400 | 0.10 | 30 | 6.4 | 3.6 ± 0.8 | VDRS05C460xyE |
| | | | 1240 | 10.0 | 63.0 | 1200 | 0.50 | 75 | 6.4 | 3.6 ± 0.8 | VDRS07H460xyE |
| | | | 1240 | 25.0 | 82.0 | 2500 | 1.50 | 150 | 6.8 | 3.8 ± 0.8 | VDRS10P460xyE |
| | | | 1240 | 50.0 | 135.0 | 4500 | 3.00 | 225 | 6.8 | 3.8 ± 0.8 | VDRS14T460xyE |
| | | | 1240 | 100.0 | 360.0 | 6500 | 3.00 | 460 | 8.5 | 4.1 ± 0.8 | VDRS20W460ByE |
| 510 | 670 | 820 | 1355 | 25.0 | 89.0 | 2500 | 1.50 | 135 | 7.2 | 4.1 ± 0.8 | VDRS10P510xyE |
| | | | 1355 | 50.0 | 145.0 | 4500 | 3.00 | 220 | 7.2 | 4.1 ± 0.8 | VDRS14T510xyE |
| | | | 1355 | 100.0 | 376.0 | 6500 | 3.00 | 450 | 8.9 | 4.4 ± 0.8 | VDRS20W510ByE |
| 550 | 745 | 910 | 1500 | 25.0 | 98.0 | 2500 | 1.50 | 120 | 7.9 | 4.5 ± 0.8 | VDRS10P550xyE |
| | | | 1500 | 50.0 | 160.0 | 4500 | 3.00 | 180 | 7.9 | 4.5 ± 0.8 | VDRS14T550xyE |
| | | | 1500 | 100.0 | 408.0 | 6500 | 3.00 | 370 | 9.5 | 4.9 ± 0.8 | VDRS20W550ByE |
| 625 | 825 | 1000 | 1650 | 100.0 | 448.0 | 6500 | 3.00 | 320 | 10.1 | 5.3 ± 0.8 | VDRS20W625ByE |
| 680 | 895 | 1100 | 1815 | 100.0 | 496.0 | 6500 | 3.00 | 270 | 10.6 | 5.8 ± 0.8 | VDRS20W680ByE |

Notes

- (1) The products are certified according to cULus (E332800), and VDE/IEC (40002622). See Agency Approval section for certificate download
- (2) The sinusoidal voltage is assumed as the normal operating condition. If a non-sinusoidal voltage is present, type selection should be based on multiplying the peak voltage by a factor of 0.707.
- (3) The voltage measured at 1 mA meets the requirements of IEC 61051.
The tolerance on the voltage at 1 mA is ± 10 %.
- (4) High energy surges are generally of longer duration. The maximum energy for one pulse of 10 x 1000 µs is given as a reference for longer duration pulses. This pulse can be characterized by peak current (I_p) and pulse width t₂ (virtual time of half I_p value, following IEC 60060-2, section 6). If V_p is the clamping voltage corresponding to I_p, the energy absorbed in the varistor is determined by the formula:
 $E = K \times V_p \times I_p \times t_2$
where K is dependent on the value of t₂ when the value of t₁ is between 8 µs and 10 µs (see Peak Current as a Function of Pulse Width drawing)
- (5) A current wave of 8 x 20 µs is used as a standard for pulse current and clamping voltage ratings. The maximum non-repetitive transient current is given for one pulse applied during the life of the component.
- (6) For composition of the SAP part number:

| | | | |
|----------------|------------------------|----------------|---|
| Replace “x” by | B for bulk type | Replace “y” by | S for straight leads |
| | T for tape and reel | | F for straight leads with flange (bulk only) |
| | A for tape and ammpack | | G for straight leads with flange and H ₀ = 16 mm (tape and reel/ammo) |
| | | | H for straight leads with flange and H ₀ = 18.25 mm (tape and reel/ammo) |
| | | | K for kinked leads (bulk only) |
| | | | L for kinked leads with H ₀ = 16 mm (tape and reel/ammo) |
| | | | M for kinked leads with H ₀ = 18.25 mm (tape and reel/ammo) |
- (7) All varistors are UL 1449 edition 4 recognized as SPD type 5 (component level) for operating temperatures up to 85 °C. The varistors may be used in other SPD types as 2, 3, or 4 depending on the indicated I_N nominal discharge current ratings. The final acceptance of the component is dependent upon its installation and use in complete equipment submitted to underwriters laboratories Inc.



ELECTRICAL CHARACTERISTICS

| ELECTRICAL DATA | | |
|--|--------------|-----------------|
| PARAMETER | VALUE | UNIT |
| Maximum continuous voltage: | | |
| RMS | 14 to 680 | V |
| DC | 18 to 895 | V |
| Maximum non-repetitive transient current (I_{NRP}) ($8 \times 20 \mu s$) | | |
| VDRS05 | 100 or 400 | A |
| VDRS07 | 250 or 1200 | A |
| VDRS10 | 500 or 2500 | A |
| VDRS14 | 1000 or 4500 | A |
| VDRS20 | 2000 or 6500 | A |
| Thermal resistance: | | |
| VDRS05 | ≈ 80 | K/W |
| VDRS07 | ≈ 70 | K/W |
| VDRS10 | ≈ 60 | K/W |
| VDRS14 | ≈ 50 | K/W |
| VDRS20 | ≈ 40 | K/W |
| Maximum dissipation: | | |
| VDRS05 | 100 | mW |
| VDRS07 | 250 | mW |
| VDRS10 | 400 | mW |
| VDRS14 | 600 | mW |
| VDRS20 | 1000 | mW |
| Temperature coefficient of voltage at 1 mA maximum | ± 0.05 | %/K |
| Voltage proof between interconnected leads and case | 2500 | V _{AC} |
| Storage temperature | -40 to +125 | °C |
| Operating temperature | -40 to +85 | °C |

DERATING CURVE

Maximum Voltage
Maximum Dissipation
Maximum Energy
Maximum Transient Current

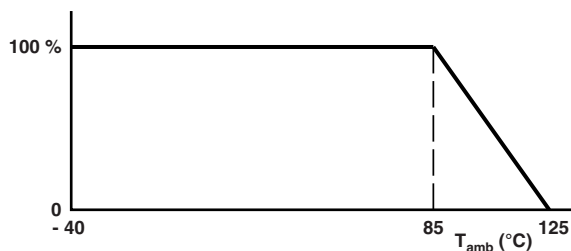

PEAK CURRENT AS A FUNCTION OF PULSE WIDTH

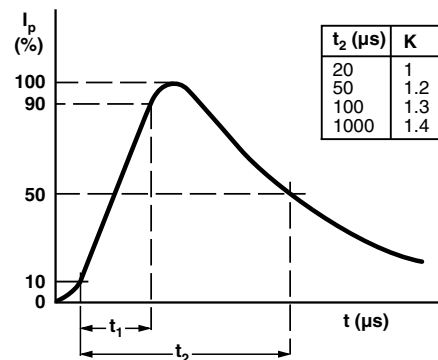

COMPONENT DIMENSIONS (BULK TYPE) in millimeters AND CATALOG NUMBERS

| D MAX. | | A MAX. | | A ₀ MAX. | | L MIN. | T ⁽¹⁾ MAX. | E ⁽¹⁾ | d | F | CATALOG NUMBER |
|-----------|-----------|-----------|-----------|------------------------|-----------|-----------|--------------------------|------------------|------------|-----------|-------------------|
| V ≤ 320 V | V > 320 V | V ≤ 300 V | V > 300 V | V ≤ 320 V | V > 320 V | | | | | | |
| 7.0 | | 9.0 | | 11.0 | | 24.0 | 6.5 | 0.7 to 3.6 | 0.6 ± 0.05 | 5 ± 1.0 | VDRS05 |
| 9.0 | | 11.0 | | 13.0 | | 24.0 | 6.5 | 0.7 to 3.6 | 0.6 ± 0.05 | 5 ± 1.0 | VDRS07 |
| 12.0 | 12.5 | 14.5 | 15.0 | 16.5 | 17.0 | 17.0 | 8.0 | 0.9 to 4.5 | 0.8 ± 0.05 | 7.5 ± 1.0 | VDRS10 |
| 16.0 | 16.5 | 19.0 | | 21.0 | 21.5 | 16.0 | 8.0 | 0.9 to 4.5 | 0.8 ± 0.05 | 7.5 ± 1.0 | VDRS14 |
| 22.5 | 23.0 | 25.5 | | 27.5 | 28.0 | 24.0 | 10.0 | 1.1 to 5.8 | 1.0 ± 0.05 | 10 ± 1.0 | VDRS20 |

Note

⁽¹⁾ T_{max}, and E values per size and voltage level can be found back in the Electrical Data and Ordering Information table

| VARISTORS IN BULK | | | | | |
|--|---|---|--|--|--|
| TYPE | VDRS05... Ø 5 mm 14 V to 460 V | VDRS07... Ø 7 mm 14 V to 460 V | VDRS10... Ø 10 mm 14 V to 550 V | VDRS14... Ø 14 mm 14 V to 550 V | VDRS20... Ø 20 mm 14 V to 680 V |
| Straight leads; see outline of components with straight leads drawing ⁽¹⁾ | BSE | BSE | BSE | BSE | BSE |
| Straight leads with flange; see outline of components with flanged leads drawing | BFE | BFE | - | - | - |
| Kinked leads; see outline of components with kinked leads drawing | BKE | BKE | BKE | BKE | BKE |
| Packaging quantities | | | | | |
| 14 V to 95 V | 250 | 250 | 250 | 100 | 50 |
| 130 V to 385 V | 250 | 250 | 250 | 100 | 50 |
| 420 V to 460 V | 250 | 250 | 200 | 100 | 50 |
| 485 V to max. V | - | 250 | 150 | 100 | 50 |

Note

⁽¹⁾ Outline of the Ø 20 mm differs from the other dimensions

DIMENSIONS in millimeters: see Component Dimensions and Electrical Data table

OUTLINE of Component with Straight Leads



OUTLINE of Component with Kinked Leads

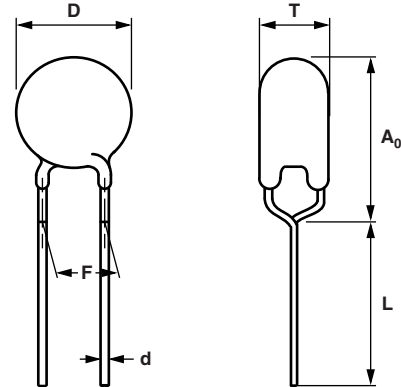

OUTLINE of Component with Flanged Leads

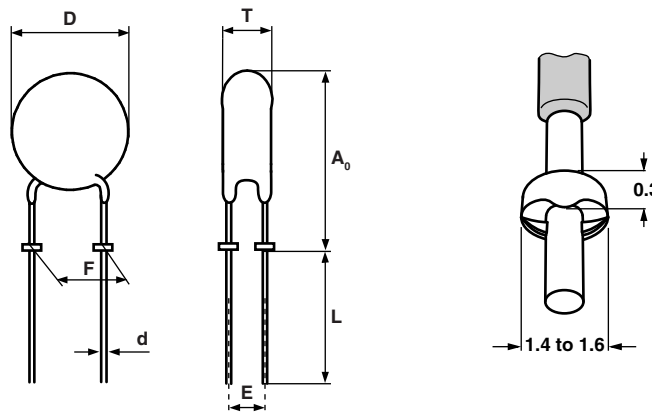

| VARISTORS ON TAPE IN AMMOPACK | | | | |
|--|---|---|--|--|
| TYPE | VDRS05... Ø 5 mm 14 V to 460 V | VDRS07... Ø 7 mm 14 V to 460 V | VDRS10... Ø 10 mm 14 V to 550 V | VDRS14... Ø 14 mm 14 V to 550 V |
| Straight leads H = 18 mm H = 20 mm See drawing: taped version with straight leads | - ASE | - ASE | ASE - | ASE - |
| Straight leads with flange H ₀ = 16 mm H ₀ = 18.25 mm See drawing: taped version with flanged leads | AGE AHE | AGE AHE | - - | - - |
| Kinked leads H ₀ = 18.25 mm H ₀ = 16 mm See drawing: taped version with kinked leads | AME ALE | AME ALE | AME ALE | AME ALE |
| Packaging quantities | | | | |
| 14 V to 210 V | 1500 ⁽¹⁾ | 1500 ⁽¹⁾ | 500 | 500 |
| 230 V to 510 V | 1000 | 1000 | 500 | 500 |
| 550 V | - | - | 400 | 400 |

Note
⁽¹⁾ Except for 35 V and 40 V = 1000 pieces

DIMENSIONS OF AMMOPACK in millimeters

| VARISTORS ON TAPE AND REEL | | | | |
|--|---|---|--|--|
| TYPE | VDRS05... Ø 5 mm 14 V to 460 V | VDRS07... Ø 7 mm 14 V to 460 V | VDRS10... Ø 10 mm 14 V to 550 V | VDRS14... Ø 14 mm 14 V to 550 V |
| Straight leads H = 18 mm H = 20 mm See drawing: taped version with straight leads | - TSE | - TSE | TSE - | TSE - |
| Straight leads with flange H ₀ = 16 mm H ₀ = 18.25 mm See drawing: taped version with flanged leads | TGE THE | TGE THE | - - | - - |
| Kinked leads H ₀ = 18.25 mm H ₀ = 16 mm See drawing: taped version with kinked leads | TME TLE | TME TLE | TME TLE | TME TLE |
| Packaging quantities | | | | |
| 14 V to 250 V | 1500 | 1500 | 1000 | 750 |
| 275 V to 300 V | 1500 | 1500 | 750 | 750 |
| 320 V to 350 V | 1000 | 1000 | 500 | 500 |
| 385 V to max. V | 1000 | 1000 | 500 | 500 |

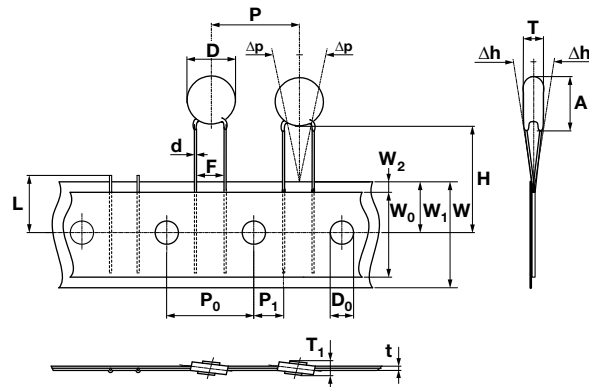
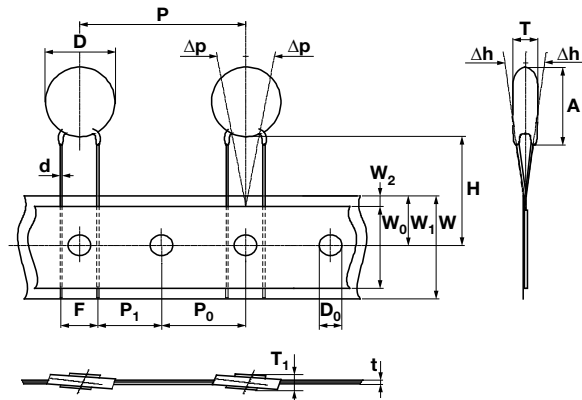
PACKAGING
TAPED VERSION WITH STRAIGHT LEADS (only for VDRS05 and VDRS07)

TAPED VERSION WITH STRAIGHT LEADS (only for VDRS10 and VDRS14)

TAPED VERSION WITH KINKED LEADS

(only for VDRS05 and VDRS07)



TAPED VERSION WITH KINKED LEADS

(only for VDRS10 and VDRS14)

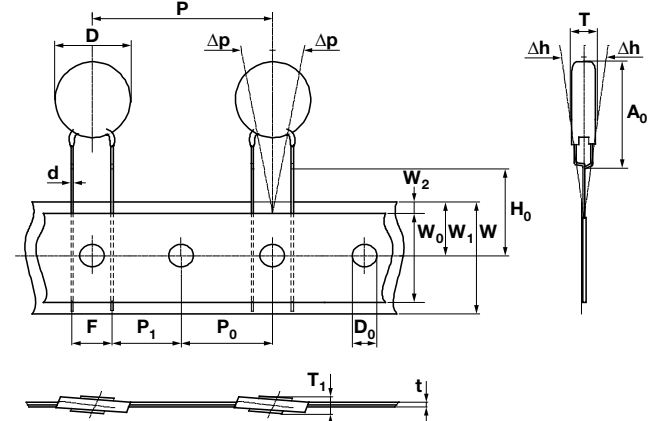

TAPED VERSION WITH FLANGED LEADS

(only for VDRS05 and VDRS07)



| TAPING DATA (based on IEC 60286-2) | | | | | |
|------------------------------------|--|---------------------------|--------|--------------------|--------|
| SYMBOL | PARAMETER | DIMENSIONS/TOLERANCE | | | |
| | | VDRS05 | VDRS07 | VDRS10 | VDRS14 |
| A max. | Max. mounting height | $V \leq 300 \text{ V}$ | | 14.5 | 19.0 |
| | | $V > 300 \text{ V}$ | 9.0 | 11.0 | |
| A_0 max. | Max. mounting height | $V \leq 320 \text{ V}$ | | 16.5 | 21.0 |
| | | $V > 320 \text{ V}$ | 11.0 | 13.0 | |
| D max. | Max. body diameter | $V \leq 320 \text{ V}$ | | 12.0 | 16.0 |
| | | $V > 320 \text{ V}$ | 7.0 | 9.0 | |
| d | Lead wire diameter | 0.6 ± 0.05 | | 0.8 ± 0.05 | |
| F | Lead to lead distance ⁽¹⁾ | $5.0 + 0.8/- 0.2$ | | 7.5 ± 0.8 | |
| H | Distance component to tape center ⁽²⁾ | $20.0 + 2.0/- 0.0$ | | $18.0 + 2.0/- 0.0$ | |
| H_0 | Lead wire clinch height | 16.0 or 18.25 ± 0.5 | | | |
| P | Pitch of components on tape | 12.7 ± 1.0 | | 25.4 ± 1.0 | |
| T | Total thickness | See Electrical Data table | | | |

Notes

- (1) Guaranteed between component and tape
- (2) For VDRS14T510xSE and VDRS14T550xSE: $H = 20 \text{ mm} \pm 1 \text{ mm}$



V/I CHARACTERISTICS

14 V_{RMS} to 40 V_{RMS} ; VDRS05

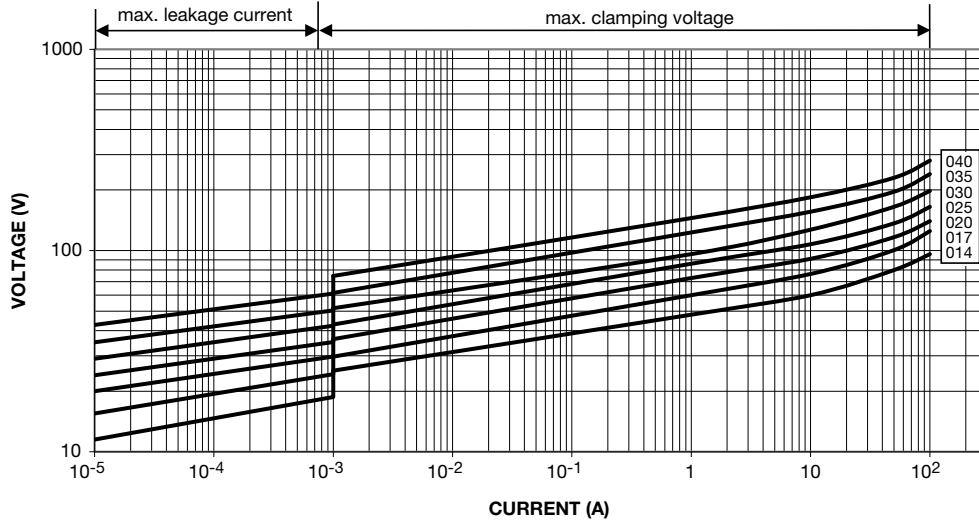

50 V_{RMS} to 175 V_{RMS} ; VDRS05

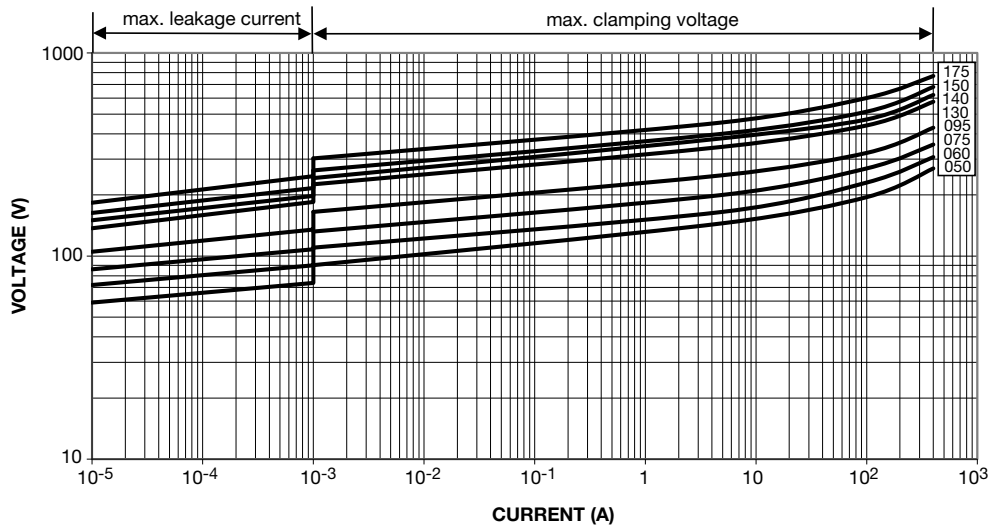

230 V_{RMS} to 460 V_{RMS} ; VDRS05

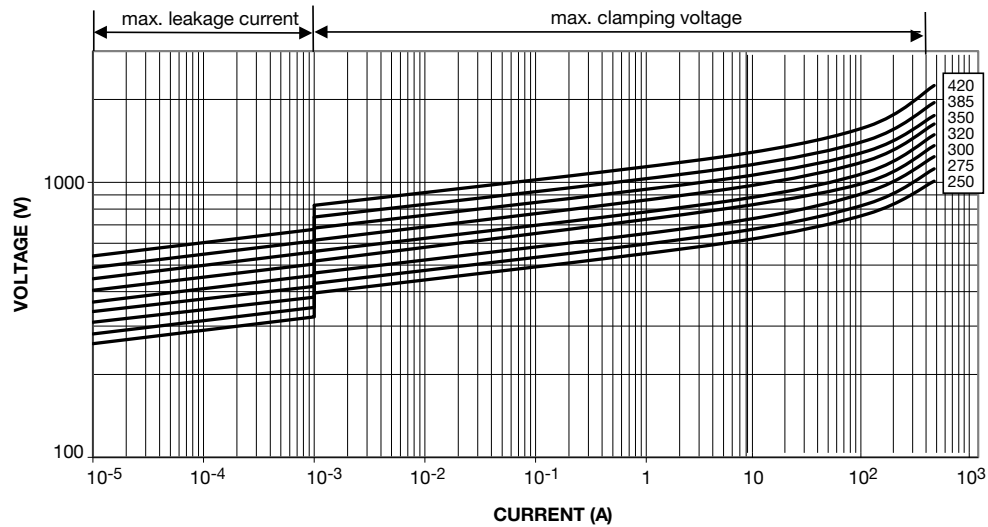



14 V_{RMS} to 40 V_{RMS}; VDRS07

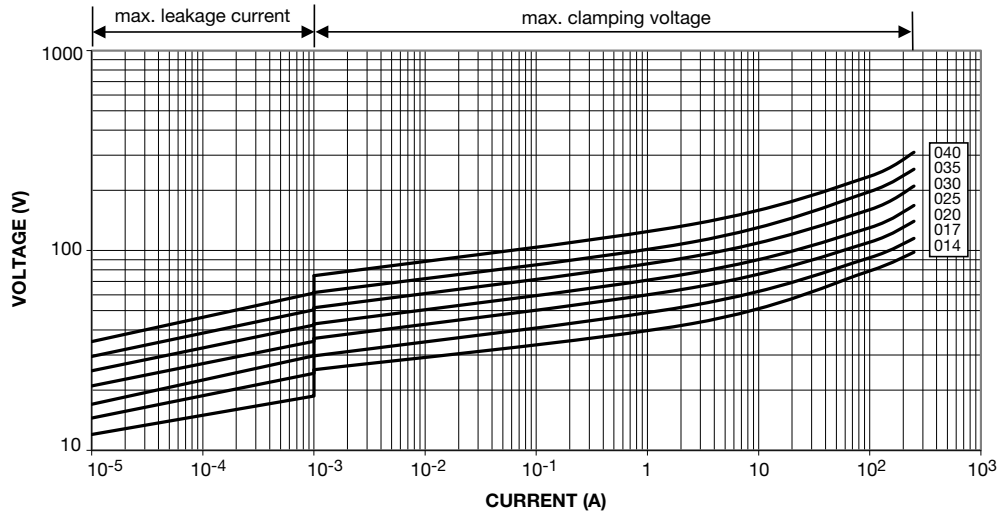

50 V_{RMS} to 175 V_{RMS}; VDRS07

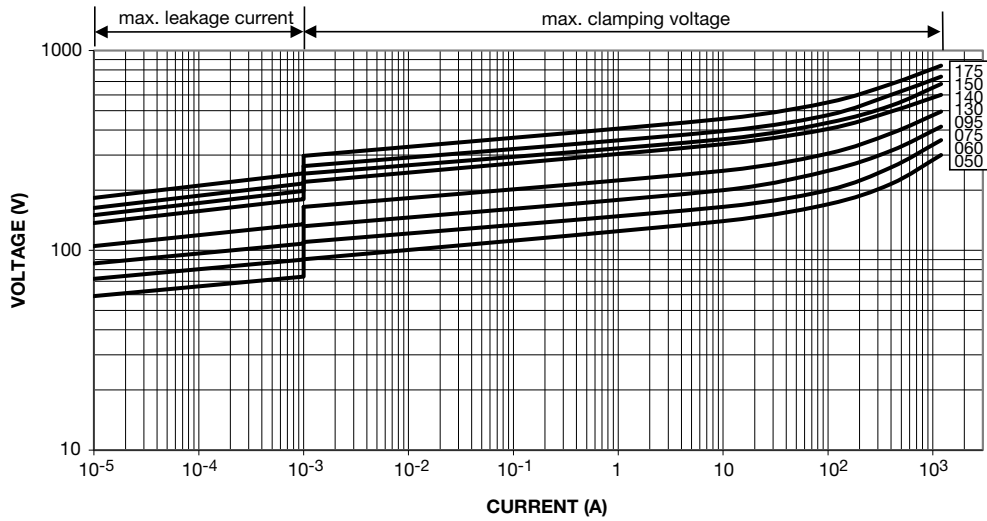

230 V_{RMS} to 460 V_{RMS}; VDRS07

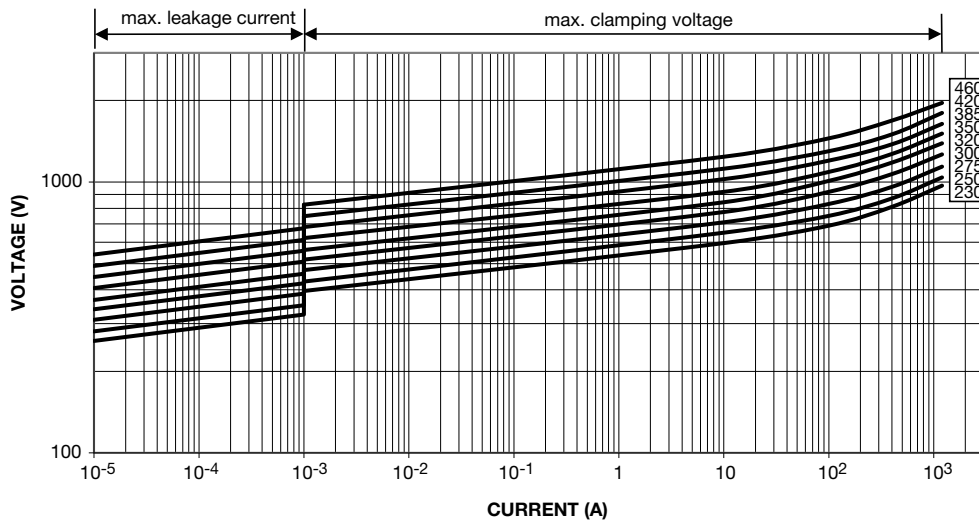



14 V_{RMS} to 40 V_{RMS}; VDRS10

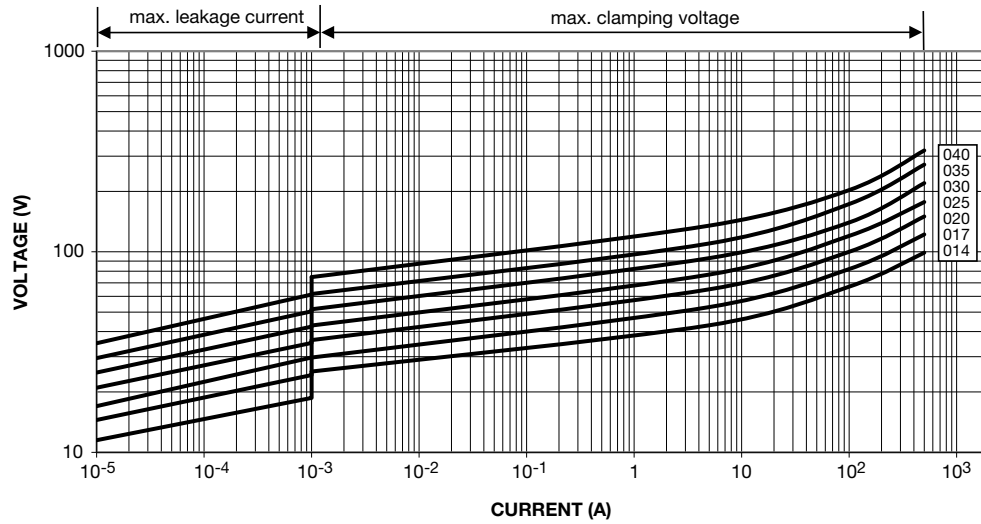

50 V_{RMS} to 230 V_{RMS}; VDRS10

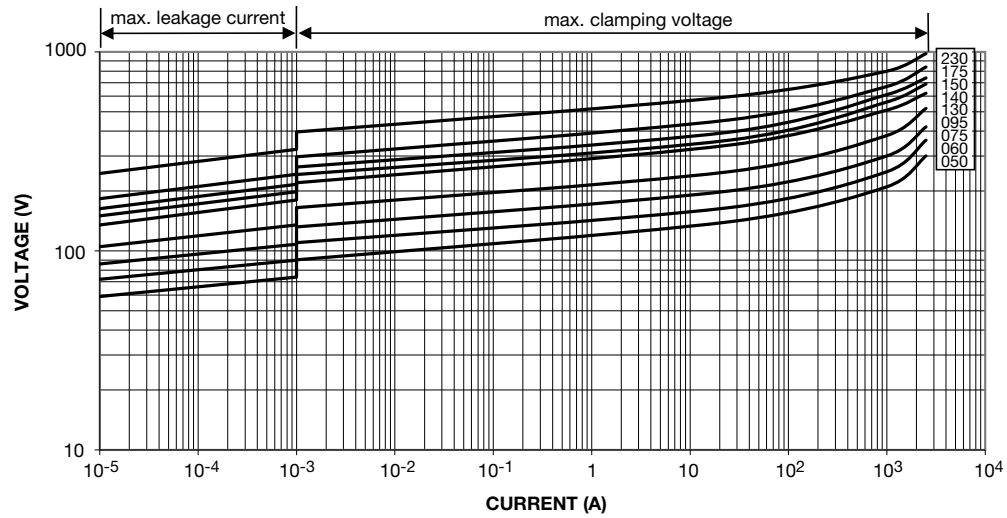

250 V_{RMS} to 550 V_{RMS}; VDRS10

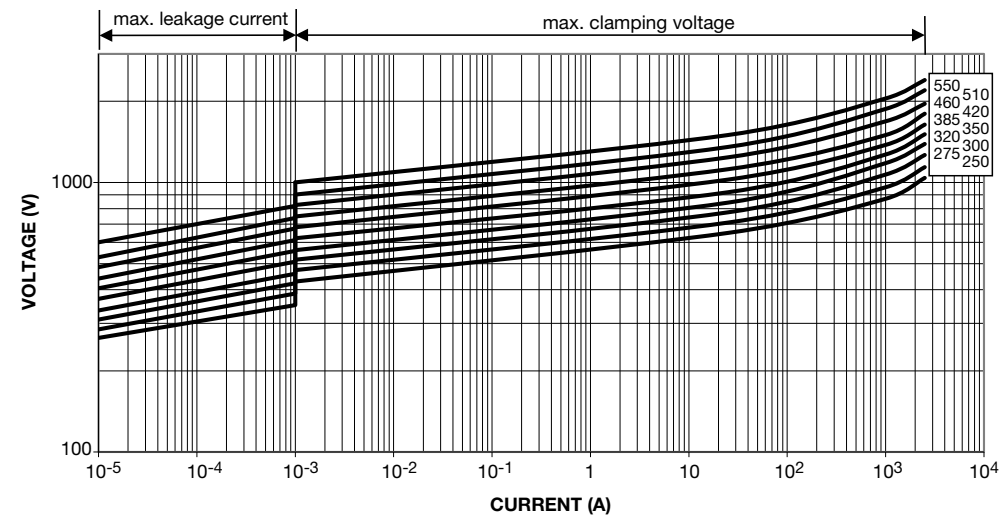



14 V_{RMS} to 40 V_{RMS}; VDRS14

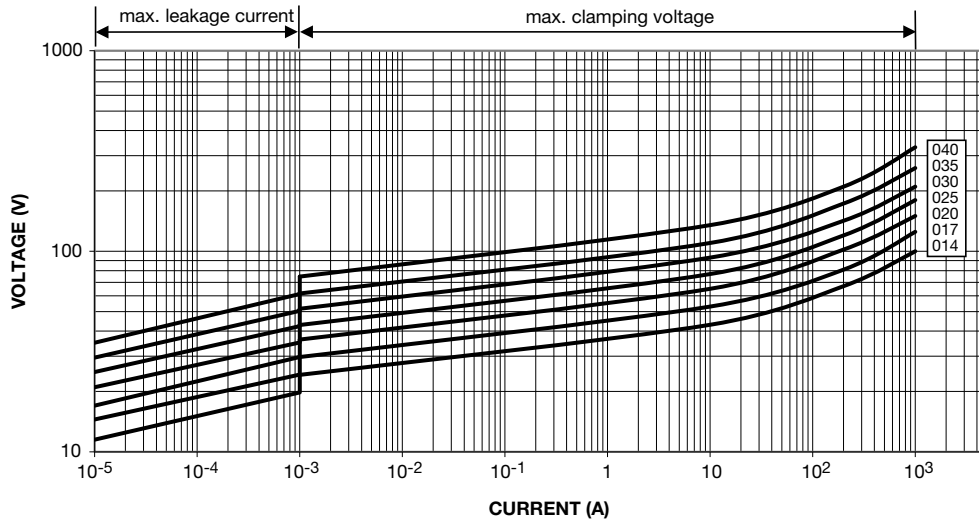

50 V_{RMS} to 230 V_{RMS}; VDRS14

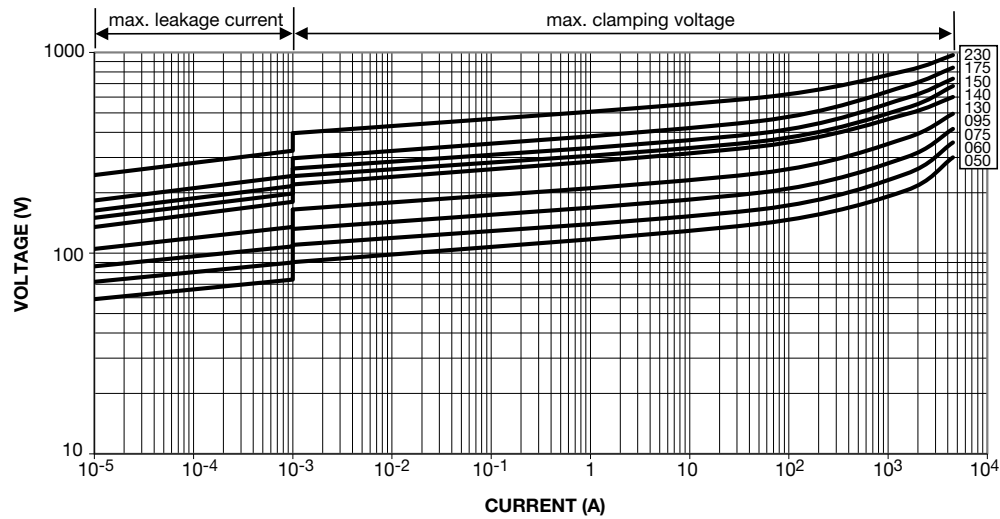

250 V_{RMS} to 550 V_{RMS}; VDRS14





14 V_{RMS} to 40 V_{RMS}; VDRS20

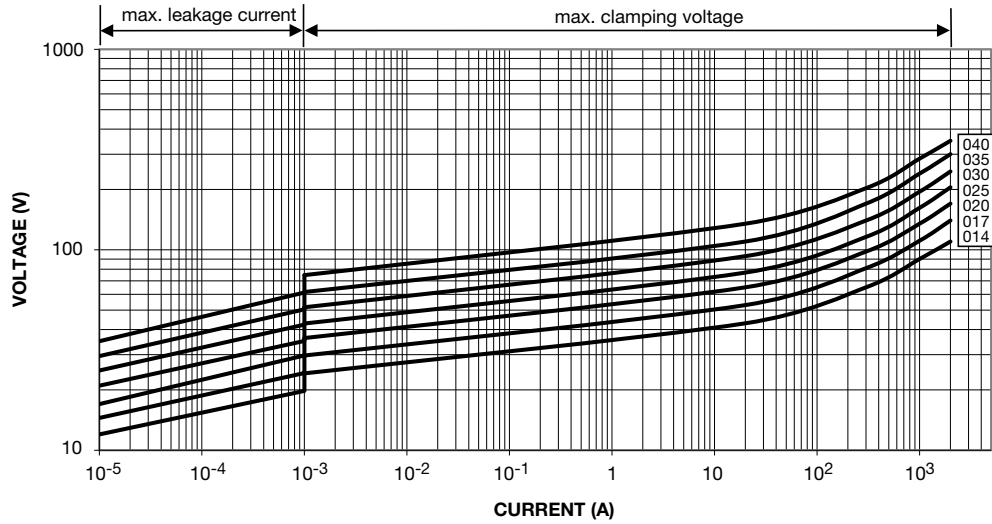

60 V_{RMS} to 250 V_{RMS}; VDRS20

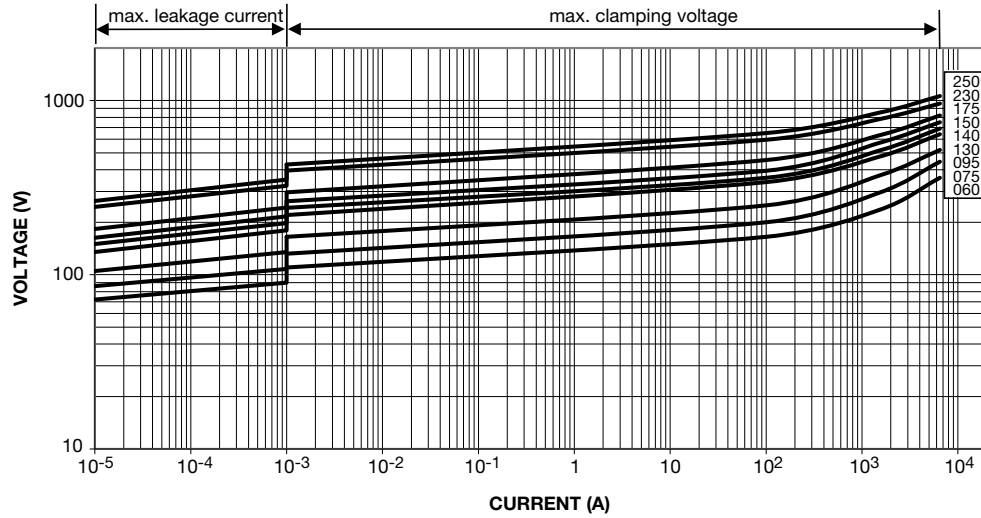

275 V_{RMS} to 680 V_{RMS}; VDRS20

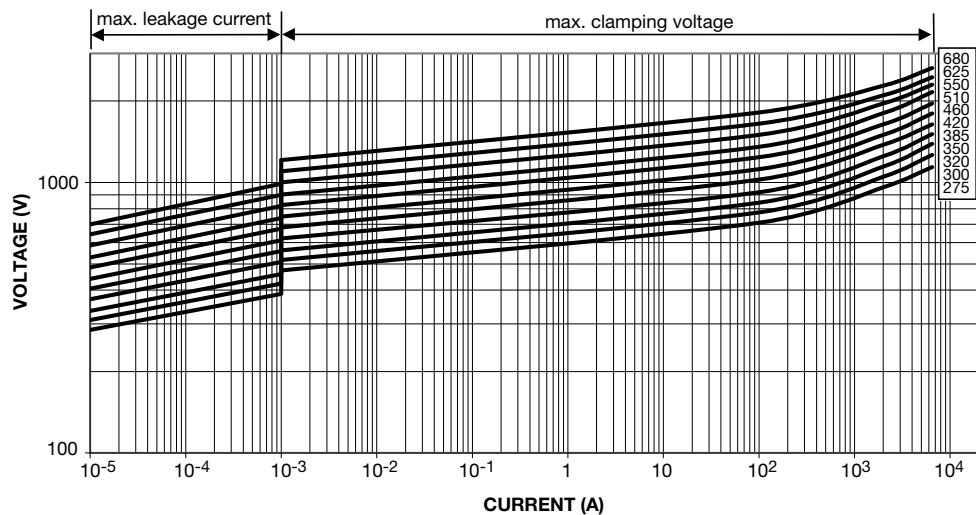



MAXIMUM APPLICABLE TRANSIENT CURRENT AS A FUNCTION OF PULSE DURATION

14 V_{RMS} to 40 V_{RMS}; VDRS05

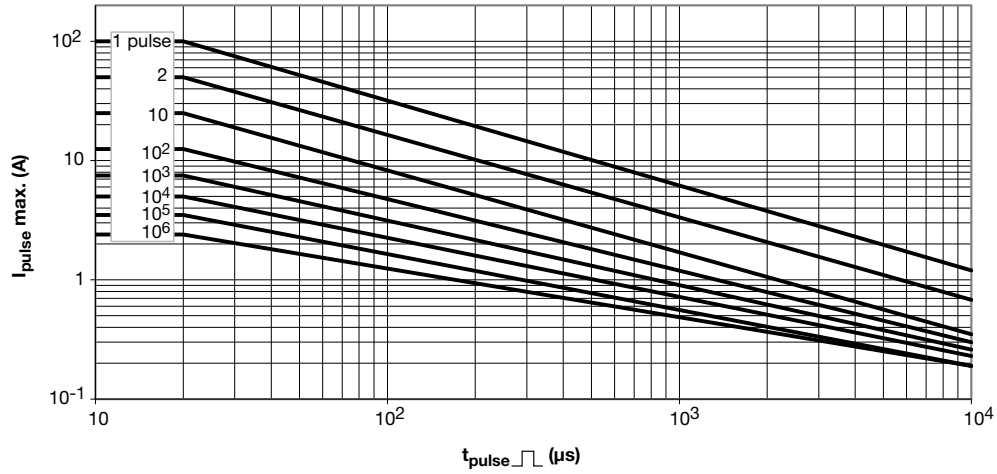

50 V_{RMS} to 460 V_{RMS}; VDRS05

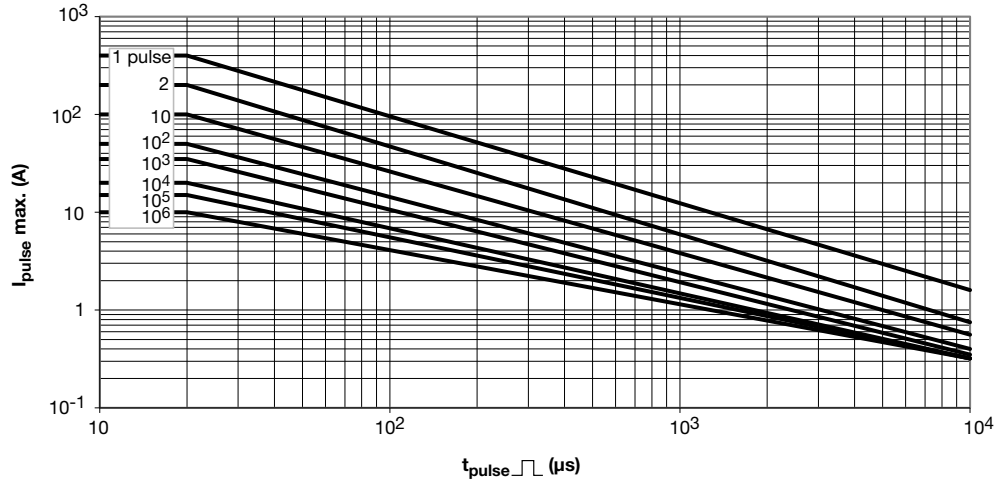

14 V_{RMS} to 40 V_{RMS}; VDRS07

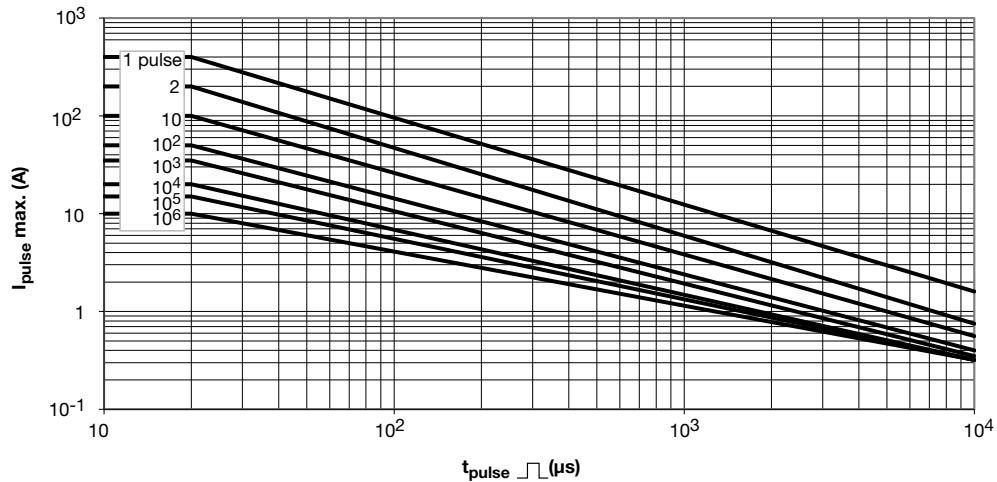



50 V_{RMS} to 510 V_{RMS}; VDRS07

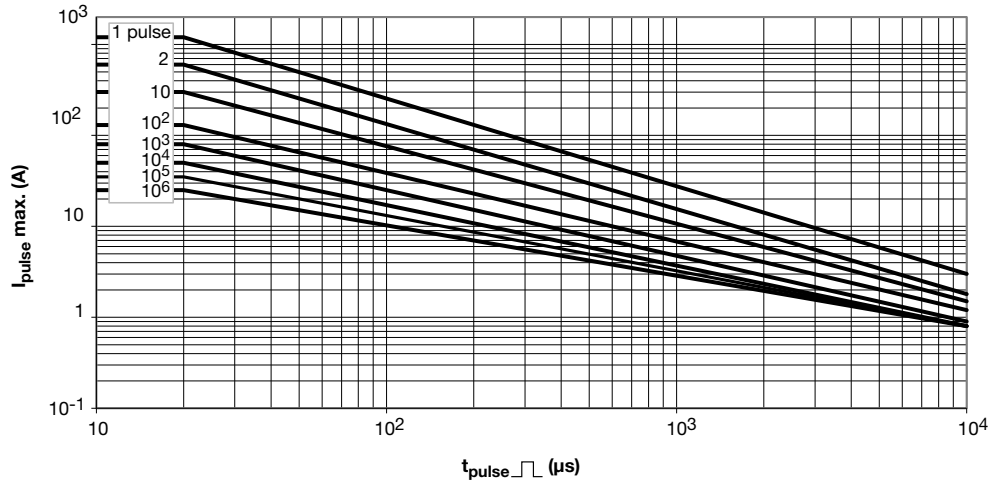

14 V_{RMS} to 40 V_{RMS}; VDRS10

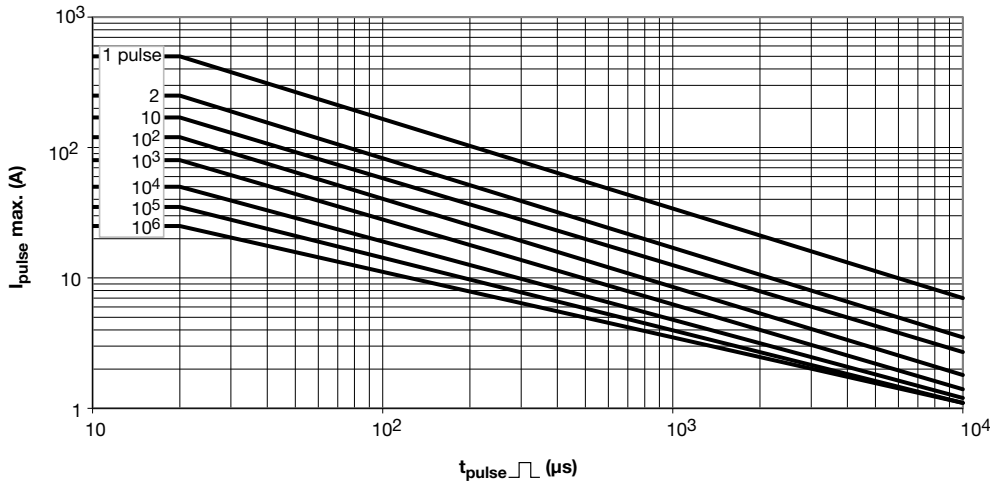

50 V_{RMS} to 300 V_{RMS}; VDRS10

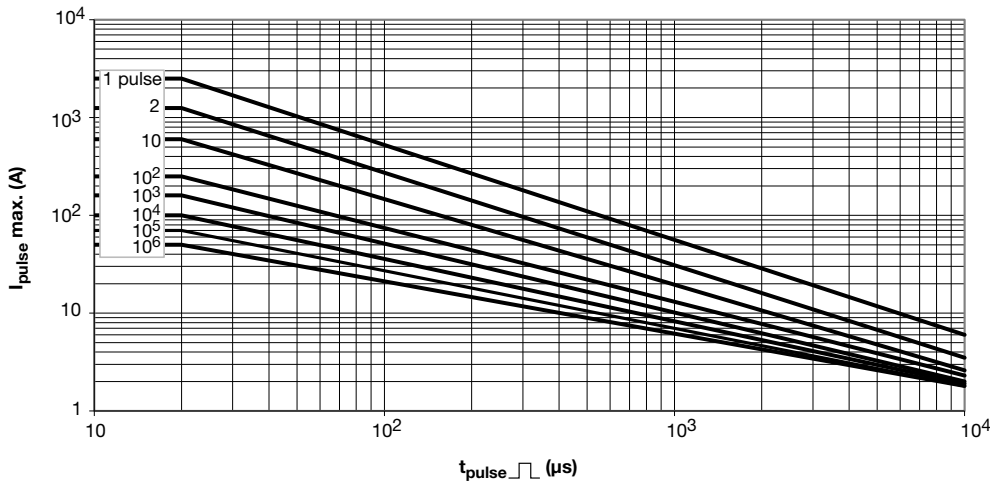



320 V_{RMS} to 680 V_{RMS}; VDRS10

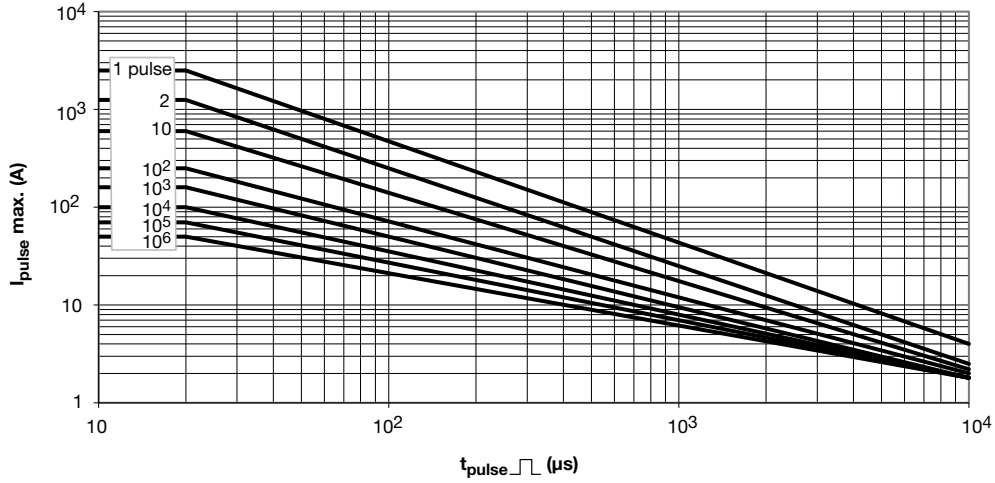

14 V_{RMS} to 40 V_{RMS}; VDRS14

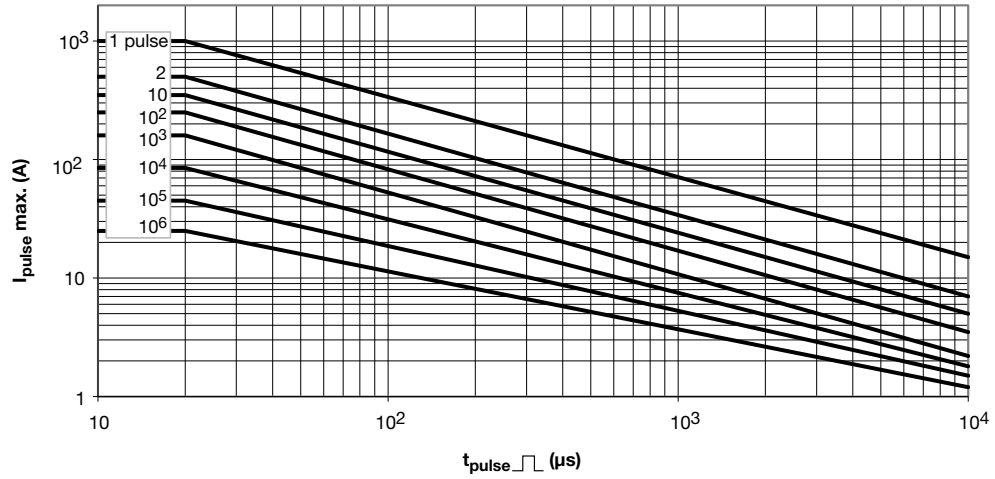

50 V_{RMS} to 300 V_{RMS}; VDRS14

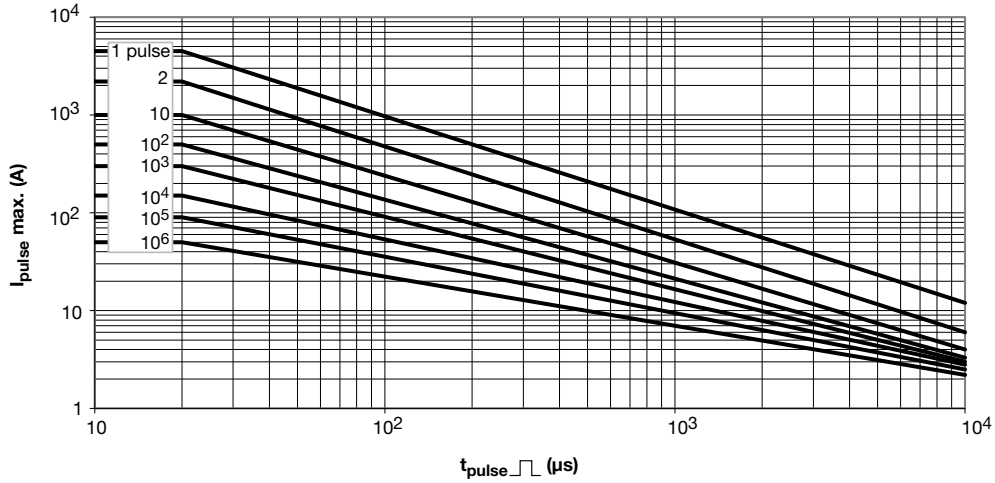



320 V_{RMS} to 680 V_{RMS}; VDRS14

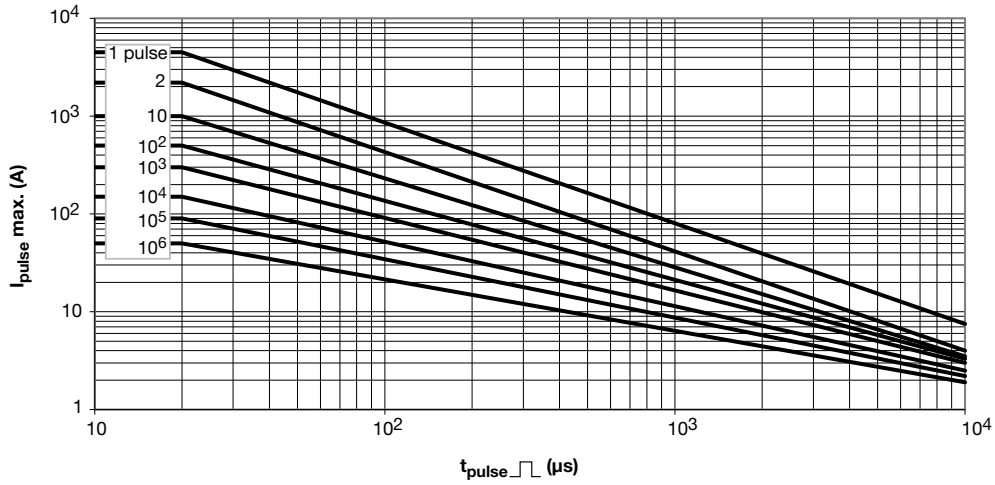

14 V_{RMS} to 40 V_{RMS}; VDRS20

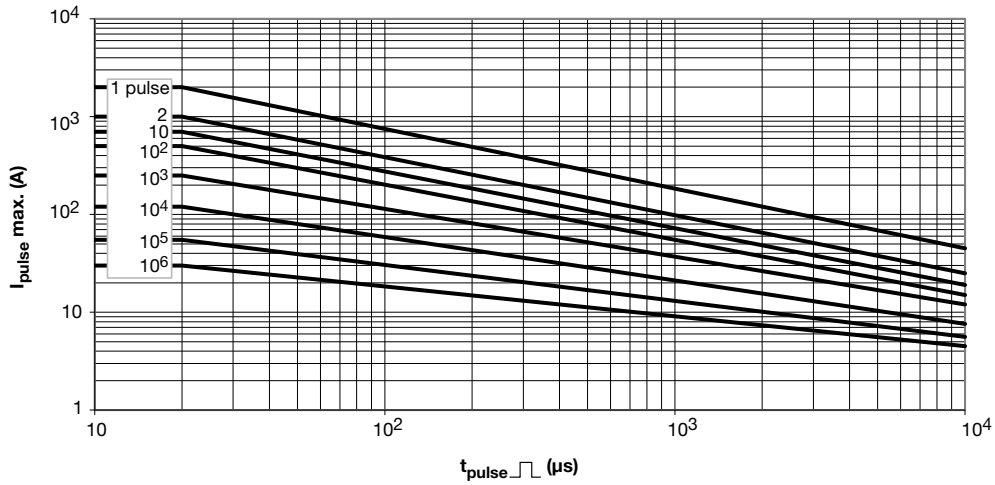

60 V_{RMS} to 300 V_{RMS}; VDRS20

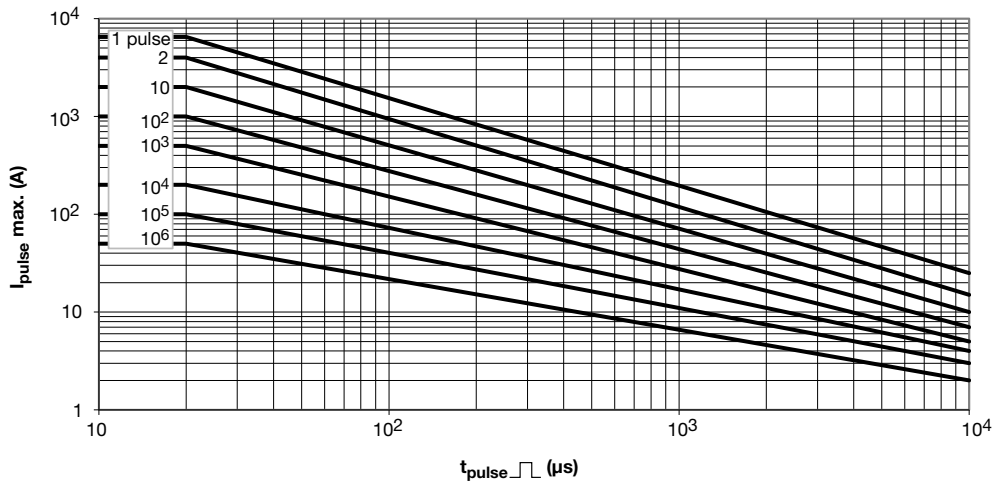



320 V_{RMS} to 680 V_{RMS}; VDRS20

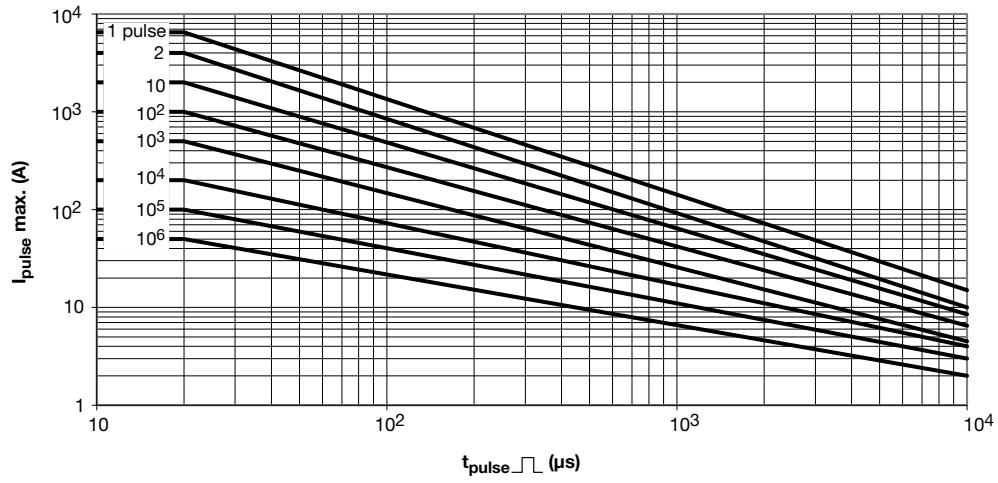



Disclaimer

ALL PRODUCT, PRODUCT SPECIFICATIONS AND DATA ARE SUBJECT TO CHANGE WITHOUT NOTICE TO IMPROVE RELIABILITY, FUNCTION OR DESIGN OR OTHERWISE.

Vishay Intertechnology, Inc., its affiliates, agents, and employees, and all persons acting on its or their behalf (collectively, "Vishay"), disclaim any and all liability for any errors, inaccuracies or incompleteness contained in any datasheet or in any other disclosure relating to any product.

Vishay makes no warranty, representation or guarantee regarding the suitability of the products for any particular purpose or the continuing production of any product. To the maximum extent permitted by applicable law, Vishay disclaims (i) any and all liability arising out of the application or use of any product, (ii) any and all liability, including without limitation special, consequential or incidental damages, and (iii) any and all implied warranties, including warranties of fitness for particular purpose, non-infringement and merchantability.

Statements regarding the suitability of products for certain types of applications are based on Vishay's knowledge of typical requirements that are often placed on Vishay products in generic applications. Such statements are not binding statements about the suitability of products for a particular application. It is the customer's responsibility to validate that a particular product with the properties described in the product specification is suitable for use in a particular application. Parameters provided in datasheets and / or specifications may vary in different applications and performance may vary over time. All operating parameters, including typical parameters, must be validated for each customer application by the customer's technical experts. Product specifications do not expand or otherwise modify Vishay's terms and conditions of purchase, including but not limited to the warranty expressed therein.

Except as expressly indicated in writing, Vishay products are not designed for use in medical, life-saving, or life-sustaining applications or for any other application in which the failure of the Vishay product could result in personal injury or death. Customers using or selling Vishay products not expressly indicated for use in such applications do so at their own risk. Please contact authorized Vishay personnel to obtain written terms and conditions regarding products designed for such applications.

No license, express or implied, by estoppel or otherwise, to any intellectual property rights is granted by this document or by any conduct of Vishay. Product names and markings noted herein may be trademarks of their respective owners.