

REVISIONS				
P	LTR	DESCRIPTION	DATE	APP'D
C10	REVISED PER ECO-17-002273		10OCT2017	RK AS

SPECIFICATIONS:

MATERIALS:
CASE: NYLON 66 UL94HB, 30% GF-BLACK
ACTUATOR: PBT OR NYLON 66 UL94HB, SEE P/N TABLE
COVER: PET FILM, WHITE FINISH
MOVING CONTACT: COPPER ALLOY-SILVER FINISH
FIXED CONTACT/TERMINAL: COPPER ALLOY-SILVER OVER NICKEL FINISH

ELECTRICAL:
MAX CONTACT RATING: 50MILLIAMPS@24V DC,
MIN CONTACT RATING: 10MICROAMPS@1V DC
INITIAL CONTACT RESISTANCE, 100 MILLIOHMS MAX
INSULATION RESISTANCE, 100 MEGOHM MIN. @ 100V DC
DIELECTRIC STRENGTH, 500 V AC FOR 1 MINUTE
LIFE EXPECTANCY, 100,000 CYCLES MIN (2 CYCLES PER SECOND AND 150% ACTUATION FORCE), EXCEPT FOR THE 520 GF MODEL WHICH WOULD BE 50,000 CYCLES MIN.

MECHANICAL:
ACTUATION FORCE, SEE TABLE
ACTUATION TRAVEL, .010 +.008/-.004
LIFE EXPECTANCY, 100,000 CYCLES MIN (2 CYCLES PER SECOND AND 150% ACTUATION FORCE), EXCEPT FOR THE 520 GF MODEL WHICH WOULD BE 50,000 CYCLES MIN.

ENVIRONMENTAL:
OPERATING TEMPERATURE, -35 TO +85 DEGREES C
STORAGE TEMPERATURE, -35 TO +85 DEGREES C
THERMAL SHOCK, PER EIA-364-32C, -35 TO +85 DEGREES C
SOLDERABILITY, PER EIA-364-52, CLASS 2, CATEGORY 1, CATEGORY 2, 95% MINIMUM COVERAGE
RESISTANCE TO SOLDER HEAT, PER 109-202, CONDITION B

Notes
1 ALL MATERIALS AND FINISHES SHALL COMPLY WITH EU DIRECTIVE 2002/95/EC OF 27JAN2003 (ROHS).

	ACTUATOR MAT'L	ACTUATOR COLOR	ACTUATION FORCE	DIM C	DIM B	DIM A	ALCO P/N	P/N
	NYLON 6/6	BROWN	100 +/-50 GF	3.30 (.130)	7.00 (.276)	3.40 (.134)	FSM6JLHTB	3-1825910-9
OBSOLETE	PBT	BROWN	100 +/-50 GF	N/A	5.00 (.196)	1.40 (.055)	FSM4JLHTB	3-1825910-8
OBSOLETE	NYLON 6/6	YELLOW	520 +/-100 GF	3.09 (.122)	8.50 (.335)	4.90 (.193)	FSM18JAAH	3-1825910-7
OBSOLETE	NYLON 6/6	RED	260 +/-50 GF	3.09 (.122)	8.50 (.335)	4.90 (.193)	FSM18JAH	3-1825910-6
	NYLON 6/6	BLACK	160 +/-50 GF	3.09 (.122)	8.50 (.335)	4.90 (.193)	FSM18JH	3-1825910-5
OBSOLETE	NYLON 6/6	BROWN	100 +/-50 GF	3.09 (.122)	8.50 (.335)	4.90 (.193)	FSM18JLH	3-1825910-4
	NYLON 6/6	YELLOW	520 +/-100 GF	2.80 (.110)	17.00 (.669)	13.40 (.527)	FSM16JAAH	3-1825910-3
	NYLON 6/6	RED	260 +/-50 GF	2.80 (.110)	17.00 (.669)	13.40 (.527)	FSM16JAH	3-1825910-2
	NYLON 6/6	BLACK	160 +/-50 GF	2.80 (.110)	17.00 (.669)	13.40 (.527)	FSM16JH	3-1825910-1
OBSOLETE	NYLON 6/6	BROWN	100 +/-50 GF	2.80 (.110)	17.00 (.669)	13.40 (.527)	FSM16JLH	3-1825910-0
	NYLON 6/6	YELLOW	520 +/-100 GF	2.87 (.113)	13.00 (.512)	9.40 (.370)	FSM14JAAH	2-1825910-9
	NYLON 6/6	RED	260 +/-50 GF	2.87 (.113)	13.00 (.512)	9.40 (.370)	FSM14JAH	2-1825910-8
	NYLON 6/6	BLACK	160 +/-50 GF	2.87 (.113)	13.00 (.512)	9.40 (.370)	FSM14JH	2-1825910-7
	NYLON 6/6	BROWN	100 +/-50 GF	2.87 (.113)	13.00 (.512)	9.40 (.370)	FSM14JLH	2-1825910-6
OBSOLETE	NYLON 6/6	YELLOW	520 +/-100 GF	3.20 (.126)	8.00 (.315)	4.40 (.173)	FSM12JAAH	2-1825910-5
OBSOLETE	NYLON 6/6	BLACK	260 +/-50 GF	3.20 (.126)	8.00 (.315)	4.40 (.173)	FSM12JABH	2-1825910-4
OBSOLETE	NYLON 6/6	RED	260 +/-50 GF	3.20 (.126)	8.00 (.315)	4.40 (.173)	FSM12JAH	2-1825910-3
	NYLON 6/6	WHITE	160 +/-50 GF	3.20 (.126)	8.00 (.315)	4.40 (.173)	FSM12JH	2-1825910-2
OBSOLETE	NYLON 6/6	BROWN	100 +/-50 GF	3.20 (.126)	8.00 (.315)	4.40 (.173)	FSM12JLH	2-1825910-1
OBSOLETE	NYLON 6/6	YELLOW	520 +/-100 GF	3.25 (.128)	7.30 (.287)	3.70 (.146)	FSM10JAAH	2-1825910-0
	NYLON 6/6	RED	260 +/-50 GF	3.25 (.128)	7.30 (.287)	3.70 (.146)	FSM10JAH	1-1825910-9
	NYLON 6/6	IVORY	160 +/-50 GF	3.25 (.128)	7.30 (.287)	3.70 (.146)	FSM10JH	1-1825910-8
OBSOLETE	NYLON 6/6	BROWN	100 +/-50 GF	3.25 (.128)	7.30 (.287)	3.70 (.146)	FSM10JLH	1-1825910-7
OBSOLETE	PBT	YELLOW	520 +/-100 GF	3.10 (.122)	9.50 (.374)	5.90 (.232)	FSM8JAAH	1-1825910-6
	PBT	RED	260 +/-50 GF	3.10 (.122)	9.50 (.374)	5.90 (.232)	FSM8JAH	1-1825910-5
	PBT	BLACK	160 +/-50 GF	3.10 (.122)	9.50 (.374)	5.90 (.232)	FSM8JH	1-1825910-4
	PBT	BROWN	100 +/-50 GF	3.10 (.122)	9.50 (.374)	5.90 (.232)	FSM8JLH	1-1825910-3
	NYLON 6/6	YELLOW	520 +/-100 GF	3.30 (.130)	7.00 (.276)	3.40 (.134)	FSM6JAAH	1-1825910-2
	NYLON 6/6	RED	260 +/-50 GF	3.30 (.130)	7.00 (.276)	3.40 (.134)	FSM6JAH	1-1825910-1
	NYLON 6/6	BLUE	160 +/-50 GF	3.30 (.130)	7.00 (.276)	3.40 (.134)	FSM6JH	1-1825910-0
	NYLON 6/6	BROWN	100 +/-50 GF	3.30 (.130)	7.00 (.276)	3.40 (.134)	FSM6JLH	1825910-9
	PBT	YELLOW	520 +/-100 GF	N/A	5.00 (.196)	1.40 (.055)	FSM4JAAH	1825910-8
	PBT	RED	260 +/-50 GF	N/A	5.00 (.196)	1.40 (.055)	FSM4JAH	1825910-7
	PBT	BLACK	160 +/-50 GF	N/A	5.00 (.196)	1.40 (.055)	FSM4JH	1825910-6
OBSOLETE	PBT	BROWN	100 +/-50 GF	N/A	5.00 (.196)	1.40 (.055)	FSM4JLH	1825910-5
OBSOLETE	PBT	YELLOW	520 +/-100 GF	N/A	4.30 (.169)	0.70 (.028)	FSM2JAAH	1825910-4
	PBT	RED	260 +/-50 GF	N/A	4.30 (.169)	0.70 (.028)	FSM2JAH	1825910-3
	PBT	NATURAL	160 +/-50 GF	N/A	4.30 (.169)	0.70 (.028)	FSM2JH	1825910-2
	PBT	BROWN	100 +/-50 GF	N/A	4.30 (.169)	0.70 (.028)	FSM2JLH	1825910-1

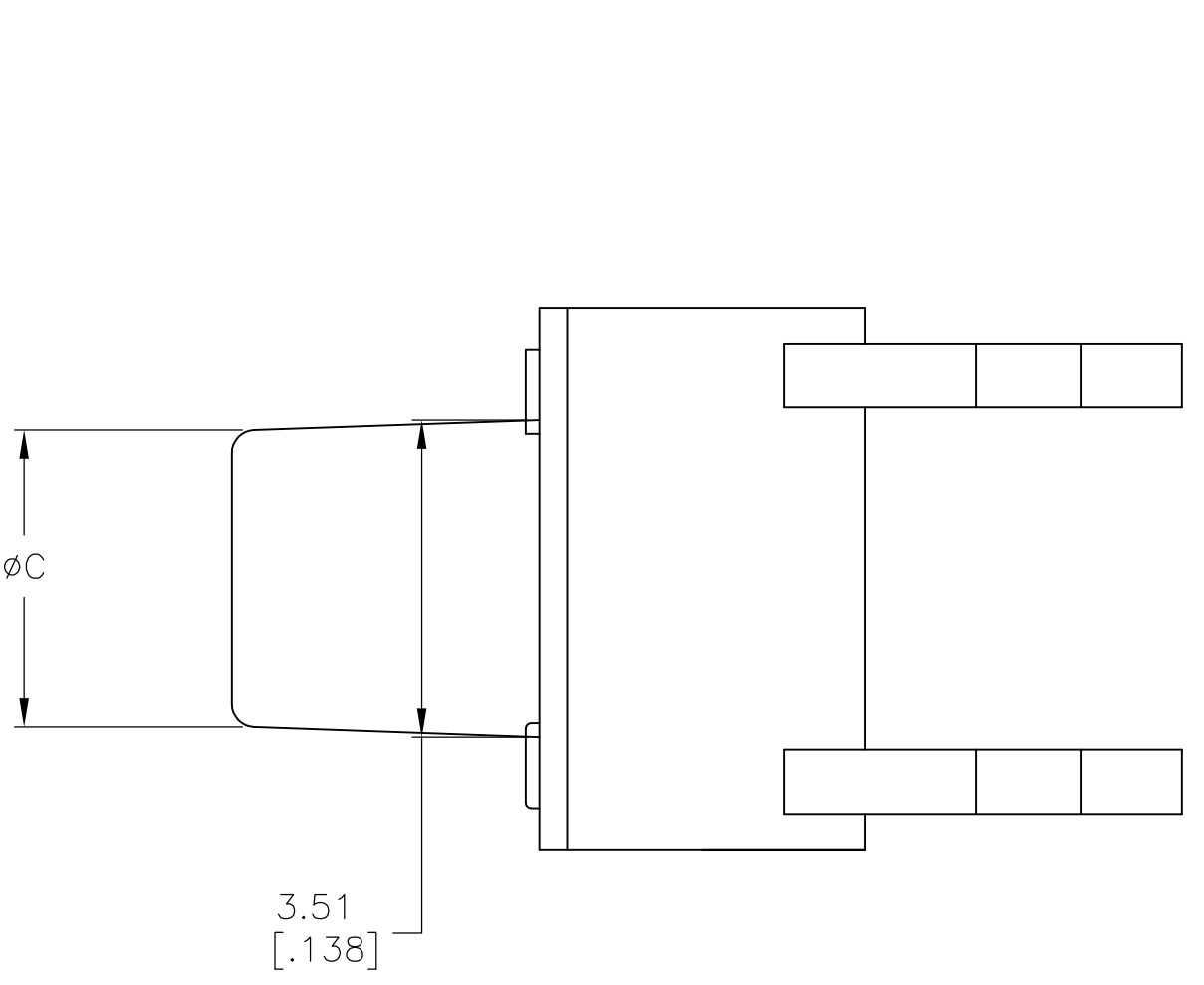
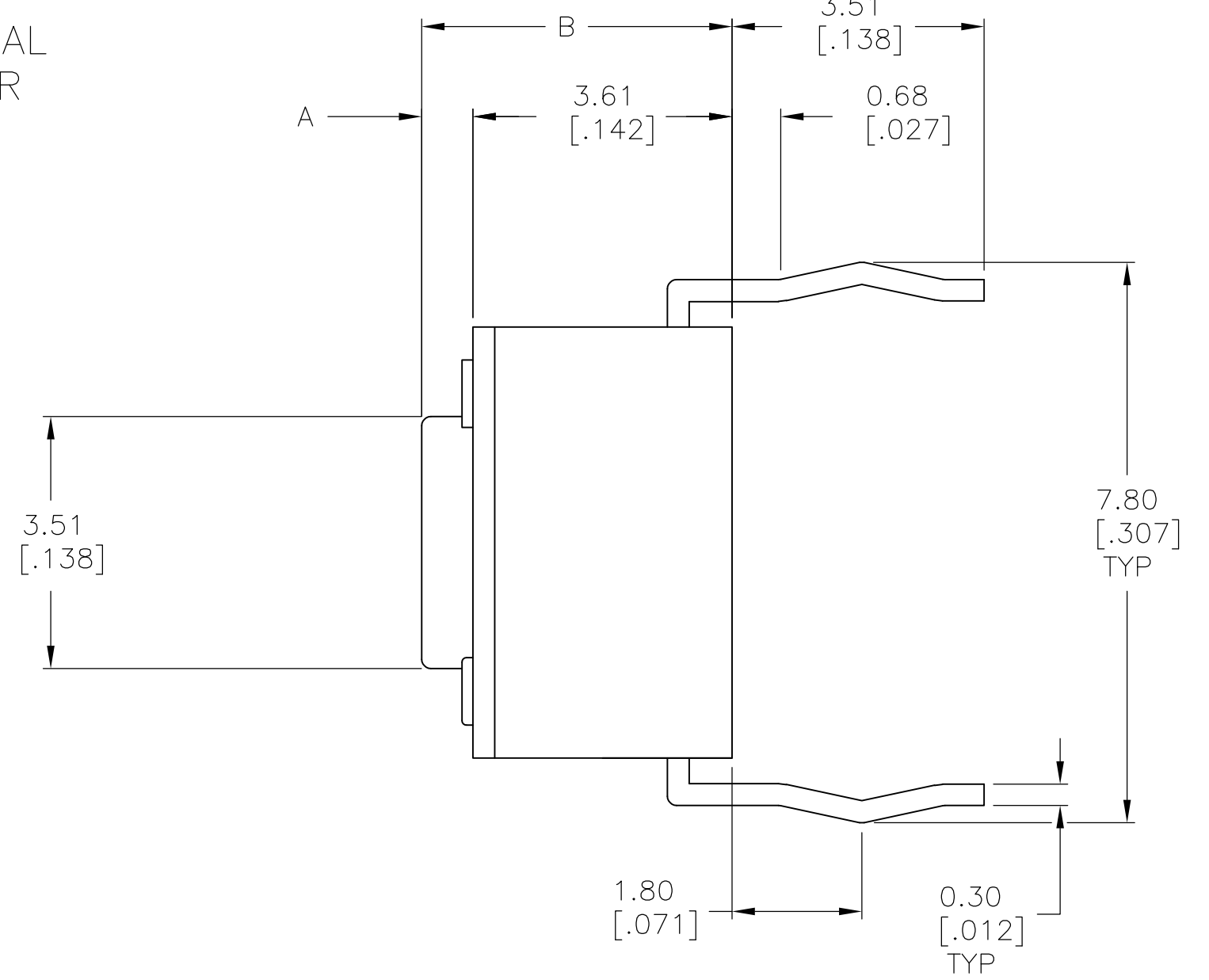
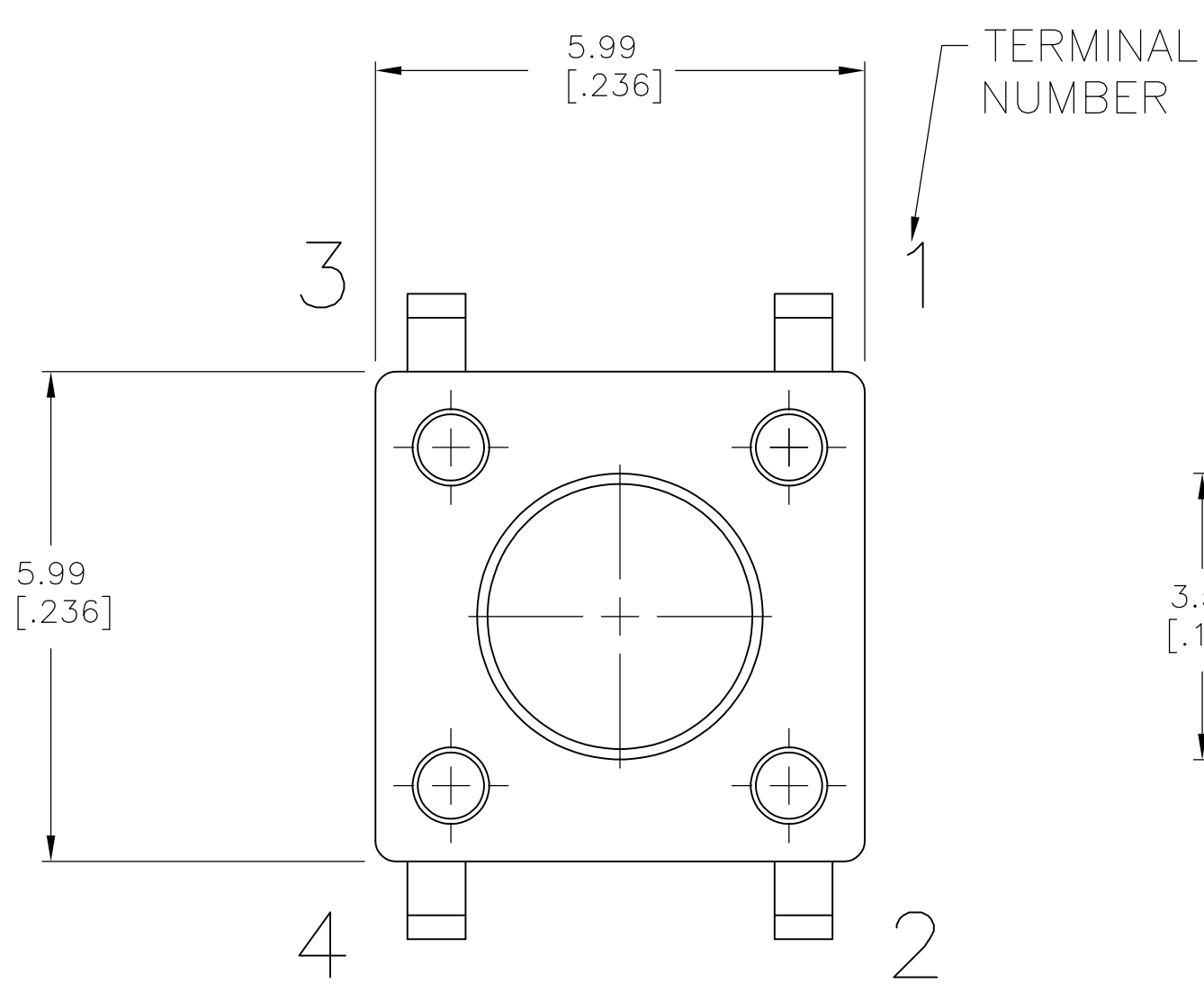

VIEW A-A
FSM6J THRU FSM18J

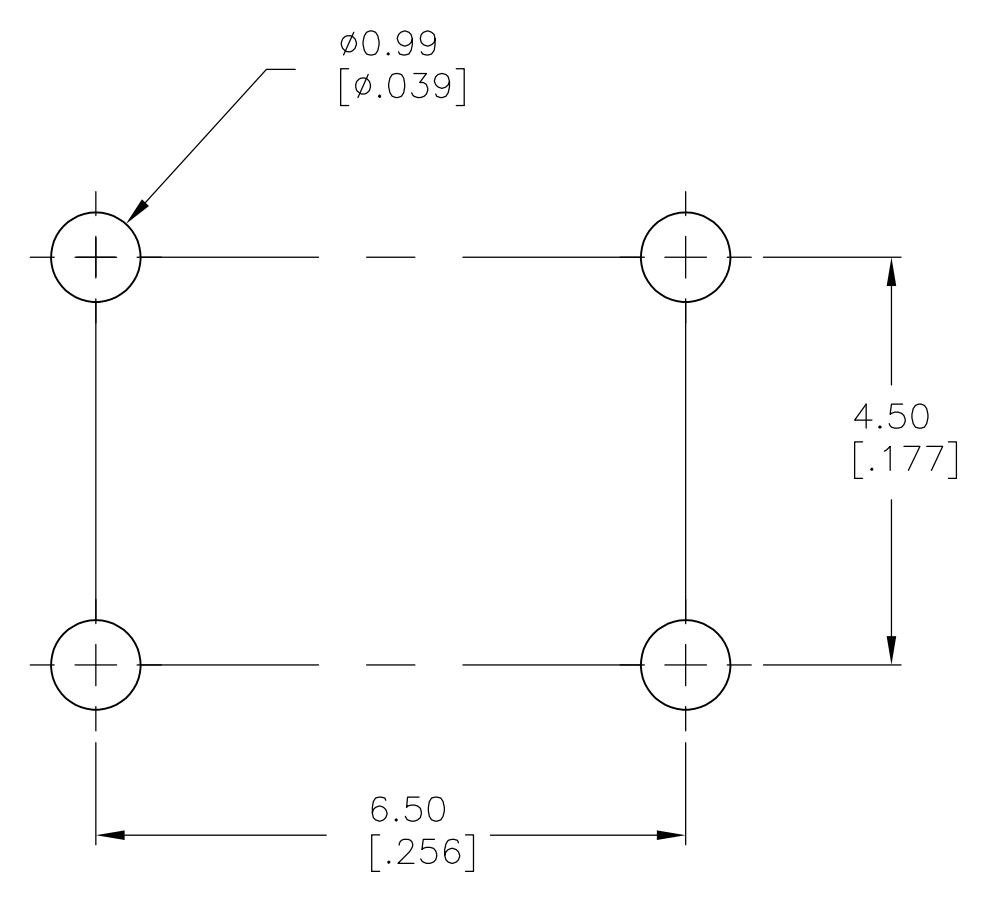
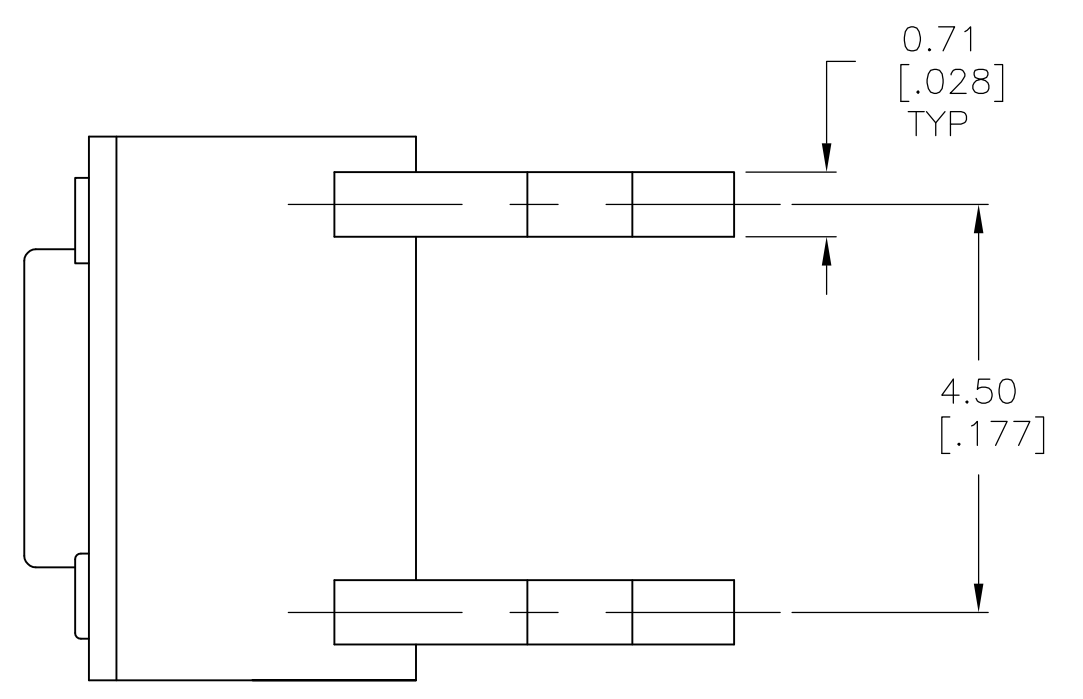

RECOMMENDED HOLE LAYOUT
TOLERANCE ±0.05[.002] UNLESS OTHERWISE NOTED

()-INDICATES MOMENTARY POSITION		
CIRCUIT CHARACTERISTICS		
CONTACT POSITION		CIRCUIT DIAGRAM
OFF	(ON) 1-3 2-4	

THIS DRAWING IS A CONTROLLED DOCUMENT.

DIMENSIONS: mm [INCHES]	TOLERANCES UNLESS OTHERWISE SPECIFIED:	0 PLC ± -	1 PLC ± -	2 PLC ± 0.30 [.012]	3 PLC ± -	4 PLC ± -	ANGLES ± -
MATERIAL: SEE SPECIFICATIONS	FINISH: -	WEIGHT: A1	00779	1825910	SCALE: 12:1	SHEET: 1 OF 1	REV: C10

STE TE Connectivity
6MM TACT SWITCH, THRU-HOLE HIGH TEMP

Mouser Electronics

Authorized Distributor

Click to View Pricing, Inventory, Delivery & Lifecycle Information:

[TE Connectivity:](#)

[FSM2JH](#)