

**PolarP™**  
**Power MOSFETs**

**IXTH16P60P**  
**IXTT16P60P**

$V_{DSS} = -600V$   
 $I_{D25} = -16A$   
 $R_{DS(on)} \leq 720m\Omega$

P-Channel Enhancement Mode  
Avalanche Rated

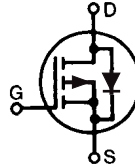

| Symbol     | Test Conditions  | Maximum Ratings |            |
|------------|--|-----------------|------------|
| $V_{DSS}$  | $T_J = 25^\circ C$ to $150^\circ C$                                | - 600           | V          |
| $V_{DGR}$  | $T_J = 25^\circ C$ to $150^\circ C$ , $R_{GS} = 1M\Omega$          | - 600           | V          |
| $V_{GSS}$  | Continuous   | $\pm 20$        | V          |
| $V_{GSM}$  | Transient  | $\pm 30$        | V          |
| $I_{D25}$  | $T_C = 25^\circ C$   | - 16            | A          |
| $I_{DM}$   | $T_C = 25^\circ C$ , Pulse Width Limited by $T_{JM}$               | - 48            | A          |
| $I_A$      | $T_C = 25^\circ C$   | - 16            | A          |
| $E_{AS}$   | $T_C = 25^\circ C$   | 2.5             | J          |
| $dv/dt$    | $I_S \leq I_{DM}$ , $V_{DD} \leq V_{DSS}$ , $T_J \leq 150^\circ C$ | 10              | V/ns       |
| $P_D$      | $T_C = 25^\circ C$   | 460             | W          |
| $T_J$      |  | - 55 ... +150   | $^\circ C$ |
| $T_{JM}$   |  | 150             | $^\circ C$ |
| $T_{stg}$  |  | - 55 ... +150   | $^\circ C$ |
| $T_L$      | 1.6mm (0.062 in.) from Case for 10s                                | 300             | $^\circ C$ |
| $T_{SOLD}$ | Plastic Body for 10s   | 260             | $^\circ C$ |
| $M_d$      | Mounting Torque (TO-247)   | 1.13 / 10       | Nm/lb.in.  |
| Weight     | TO-268   | 4               | g          |
|            | TO-247   | 6               | g          |

TO-268 (IXTT)

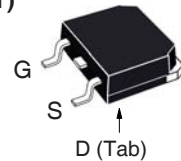

TO-247 (IXTH)

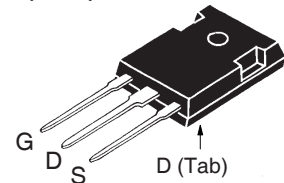

G = Gate      D = Drain  
S = Source    Tab = Drain

**Features**

- International Standard Packages
- Avalanche Rated
- Rugged PolarP™ Process
- Fast intrinsic Diode
- Low Package Inductance

**Advantages**

- Easy to Mount
- Space Savings
- High Power Density

**Applications**

- High-Side Switches
- Push-Pull Amplifiers
- DC Choppers
- Current Regulators
- Automatic Test Equipment

| Symbol       | Test Conditions<br>( $T_J = 25^\circ C$ , Unless Otherwise Specified) | Characteristic Values |      |                               |
|--------------|---|-----------------------|------|-------------------------------|
|              |   | Min.                  | Typ. | Max.                          |
| $BV_{DSS}$   | $V_{GS} = 0V$ , $I_D = -250\mu A$                                     | - 600                 |      | V                             |
| $V_{GS(th)}$ | $V_{DS} = V_{GS}$ , $I_D = -250\mu A$                                 | - 2.0                 |      | V                             |
| $I_{GSS}$    | $V_{GS} = \pm 20V$ , $V_{DS} = 0V$                                    |                       |      | $\pm 100$ nA                  |
| $I_{DSS}$    | $V_{DS} = V_{DSS}$ , $V_{GS} = 0V$<br>$T_J = 125^\circ C$             |                       |      | - 25 $\mu A$<br>- 200 $\mu A$ |
| $R_{DS(on)}$ | $V_{GS} = -10V$ , $I_D = 0.5 \cdot I_{D25}$ , Note 1                  |                       |      | 720 m $\Omega$                |

| Symbol       | Test Conditions<br>( $T_J = 25^\circ\text{C}$ , Unless Otherwise Specified)   | Characteristic Values |      |                    |
|--------------|---|-----------------------|------|--------------------|
|              |   | Min.                  | Typ. | Max.               |
| $g_{fs}$     | $V_{DS} = -10\text{V}$ , $I_D = 0.5 \cdot I_{D25}$ , Note 1   | 11                    | 18   | S                  |
| $C_{iss}$    | $V_{GS} = 0\text{V}$ , $V_{DS} = -25\text{V}$ , $f = 1\text{MHz}$   |                       | 5120 | pF                 |
| $C_{oss}$    |   |                       | 445  | pF                 |
| $C_{rss}$    |   |                       | 60   | pF                 |
| $t_{d(on)}$  | <b>Resistive Switching Times</b><br>$V_{GS} = -10\text{V}$ , $V_{DS} = 0.5 \cdot V_{DSS}$ , $I_D = 0.5 \cdot I_{D25}$<br>$R_G = 3\Omega$ (External) |                       | 29   | ns                 |
| $t_r$        |   |                       | 25   | ns                 |
| $t_{d(off)}$ |   |                       | 60   | ns                 |
| $t_f$        |   |                       | 38   | ns                 |
| $Q_{g(on)}$  | $V_{GS} = -10\text{V}$ , $V_{DS} = 0.5 \cdot V_{DSS}$ , $I_D = 0.5 \cdot I_{D25}$   |                       | 92   | nC                 |
| $Q_{gs}$     |   |                       | 27   | nC                 |
| $Q_{gd}$     |   |                       | 23   | nC                 |
| $R_{thJC}$   |   |                       | 0.27 | $^\circ\text{C/W}$ |
| $R_{thCS}$   |   | 0.21                  |      | $^\circ\text{C/W}$ |

### Source-Drain Diode

| Symbol   | Test Conditions<br>( $T_J = 25^\circ\text{C}$ , Unless Otherwise Specified)                             | Characteristic Values |        |               |
|----------|---|-----------------------|--------|---------------|
|          |   | Min.                  | Typ.   | Max.          |
| $I_S$    | $V_{GS} = 0\text{V}$  |                       |        | - 16 A        |
| $I_{SM}$ | Repetitive, Pulse Width Limited by $T_{JM}$   |                       |        | - 64 A        |
| $V_{SD}$ | $I_F = -8\text{A}$ , $V_{GS} = 0\text{V}$ , Note 1  |                       |        | - 2.8 V       |
| $t_{rr}$ | $I_F = -8\text{A}$ , $-di/dt = -150\text{A}/\mu\text{s}$<br>$V_R = -100\text{V}$ , $V_{GS} = 0\text{V}$ |                       | 440    | ns            |
| $Q_{RM}$ |   |                       | 7.4    | $\mu\text{C}$ |
| $I_{RM}$ |   |                       | - 33.6 | A             |

Note 1: Pulse test,  $t \leq 300\mu\text{s}$ , duty cycle,  $d \leq 2\%$ .

### TO-247 Outline

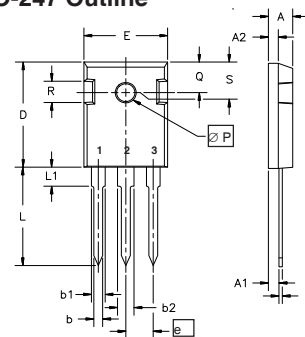

Terminals: 1 - Gate 2 - Drain  
3 - Source

| Dim.           | Millimeter |       | Inches |       |
|----------------|------------|-------|--------|-------|
|                | Min.       | Max.  | Min.   | Max.  |
| A              | 4.7        | 5.3   | .185   | .209  |
| A <sub>1</sub> | 2.2        | 2.54  | .087   | .102  |
| A <sub>2</sub> | 2.2        | 2.6   | .059   | .098  |
| b              | 1.0        | 1.4   | .040   | .055  |
| b <sub>1</sub> | 1.65       | 2.13  | .065   | .084  |
| b <sub>2</sub> | 2.87       | 3.12  | .113   | .123  |
| C              | .4         | .8    | .016   | .031  |
| D              | 20.80      | 21.46 | .819   | .845  |
| E              | 15.75      | 16.26 | .610   | .640  |
| e              | 5.20       | 5.72  | 0.205  | 0.225 |
| L              | 19.81      | 20.32 | .780   | .800  |
| L <sub>1</sub> |            | 4.50  |        | .177  |
| ∅P             | 3.55       | 3.65  | .140   | .144  |
| Q              | 5.89       | 6.40  | 0.232  | 0.252 |
| R              | 4.32       | 5.49  | .170   | .216  |
| S              | 6.15       | BSC   | 242    | BSC   |

### TO-268 Outline

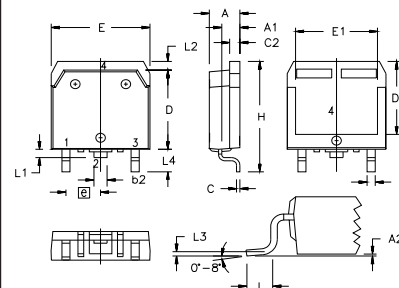

Terminals: 1 - Gate 2 - Drain  
3 - Source 4 - Drain

| SYM            | INCHES   |      | MILLIMETERS |       |
|----------------|----------|------|-------------|-------|
|                | MIN      | MAX  | MIN         | MAX   |
| A              | .193     | .201 | 4.90        | 5.10  |
| A <sub>1</sub> | .106     | .114 | 2.70        | 2.90  |
| A <sub>2</sub> | .001     | .010 | 0.02        | 0.25  |
| b              | .045     | .057 | 1.15        | 1.45  |
| b <sub>2</sub> | .075     | .083 | 1.90        | 2.10  |
| C              | .016     | .026 | 0.40        | 0.65  |
| C <sub>2</sub> | .057     | .063 | 1.45        | 1.60  |
| D              | .543     | .551 | 13.80       | 14.00 |
| D <sub>1</sub> | .488     | .500 | 12.40       | 12.70 |
| E              | .624     | .632 | 15.85       | 16.05 |
| E <sub>1</sub> | .524     | .535 | 13.30       | 13.60 |
| e              | .215 BSC |      | 5.45 BSC    |       |
| H              | .736     | .752 | 18.70       | 19.10 |
| L              | .094     | .106 | 2.40        | 2.70  |
| L <sub>1</sub> | .047     | .055 | 1.20        | 1.40  |
| L <sub>2</sub> | .039     | .045 | 1.00        | 1.15  |
| L <sub>3</sub> | .010 BSC |      | 0.25 BSC    |       |
| L <sub>4</sub> | .150     | .161 | 3.80        | 4.10  |

IXYS Reserves the Right to Change Limits, Test Conditions, and Dimensions.

|  |           |           |           |           |              |              |              |              |              |             |
|--|-----------|-----------|-----------|-----------|--------------|--------------|--------------|--------------|--------------|-------------|
| IXYS MOSFETs and IGBTs are covered by one or more of the following U.S. patents: | 4,835,592 | 4,931,844 | 5,049,961 | 5,237,481 | 6,162,665    | 6,404,065 B1 | 6,683,344    | 6,727,585    | 7,005,734 B2 | 7,157,338B2 |
|  | 4,860,072 | 5,017,508 | 5,063,307 | 5,381,025 | 6,259,123 B1 | 6,534,343    | 6,710,405 B2 | 6,759,692    | 7,063,975 B2 |             |
|  | 4,881,106 | 5,034,796 | 5,187,117 | 5,486,715 | 6,306,728 B1 | 6,583,505    | 6,710,463    | 6,771,478 B2 | 7,071,537    |             |

**Fig. 1. Output Characteristics @  $T_J = 25^\circ\text{C}$**

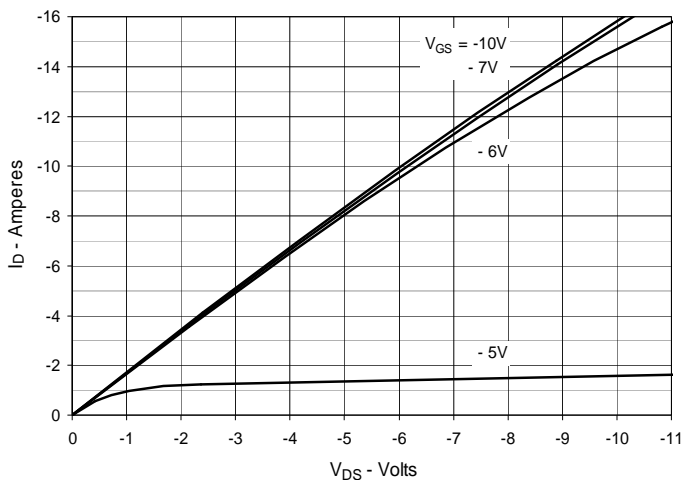

**Fig. 2. Extended Output Characteristics @  $T_J = 25^\circ\text{C}$**

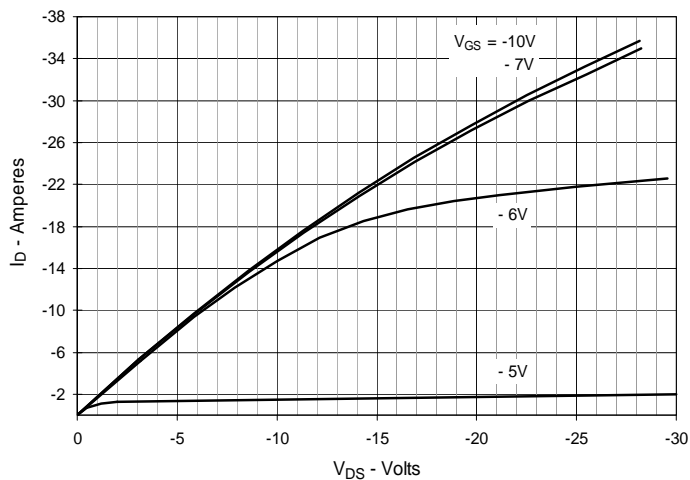

**Fig. 3. Output Characteristics @  $T_J = 125^\circ\text{C}$**

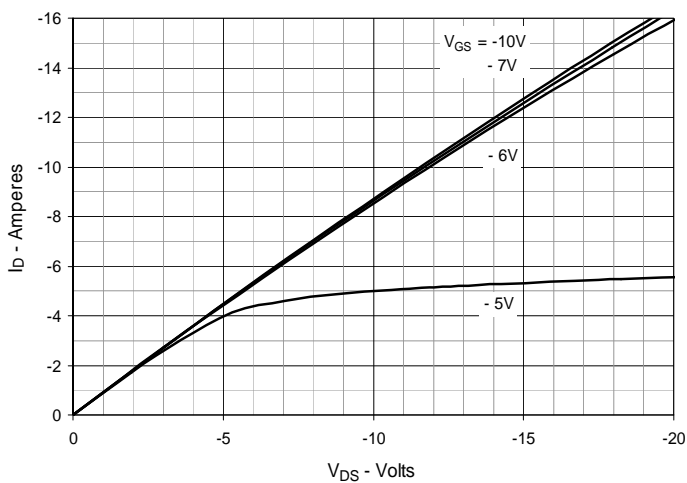

**Fig. 4.  $R_{DS(on)}$  Normalized to  $I_D = -8\text{A}$  Value vs. Junction Temperature**

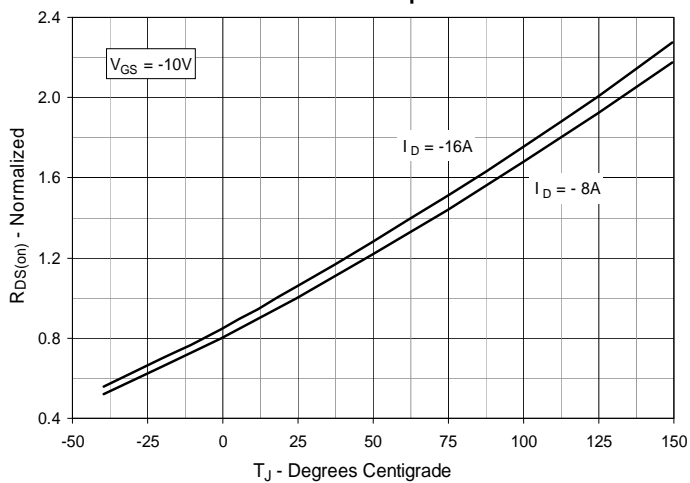

**Fig. 5.  $R_{DS(on)}$  Normalized to  $I_D = -8\text{A}$  Value vs. Drain Current**

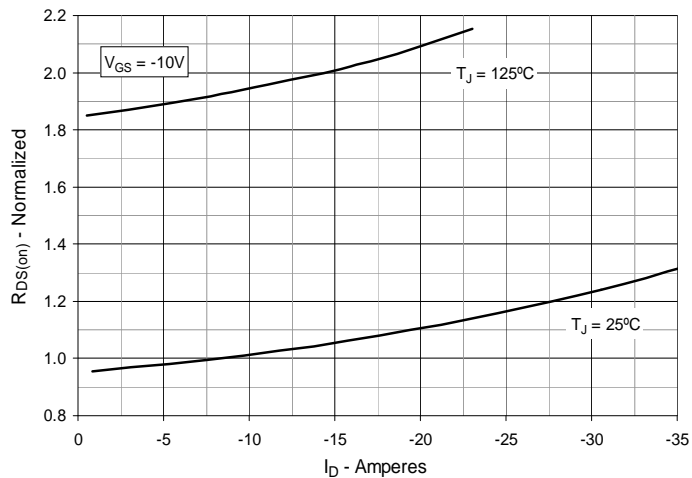

**Fig. 6. Maximum Drain Current vs. Case Temperature**

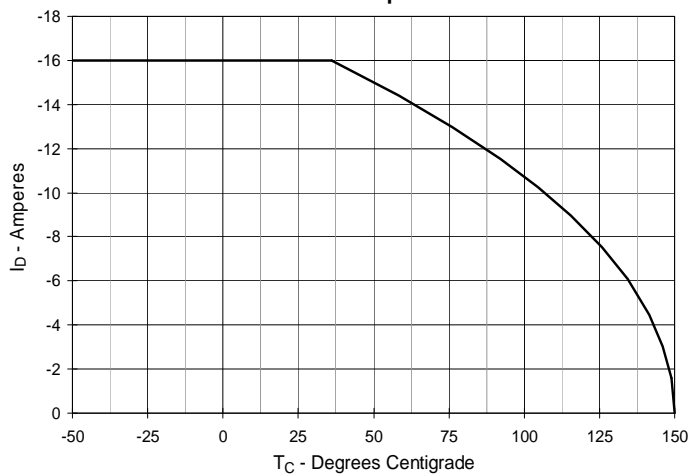

**Fig. 7. Input Admittance**

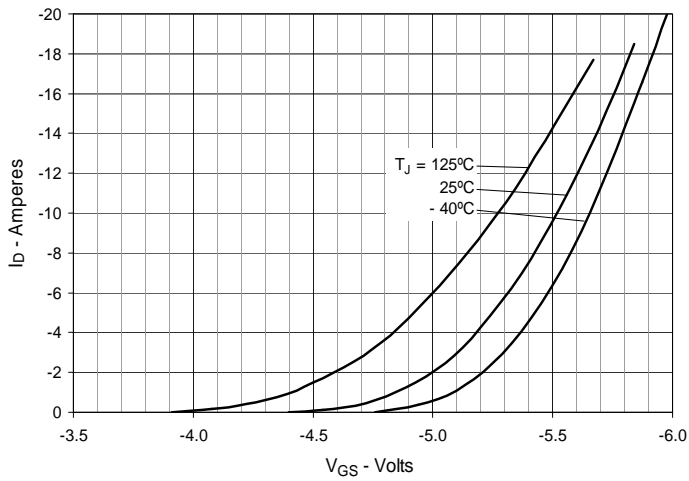

**Fig. 8. Transconductance**

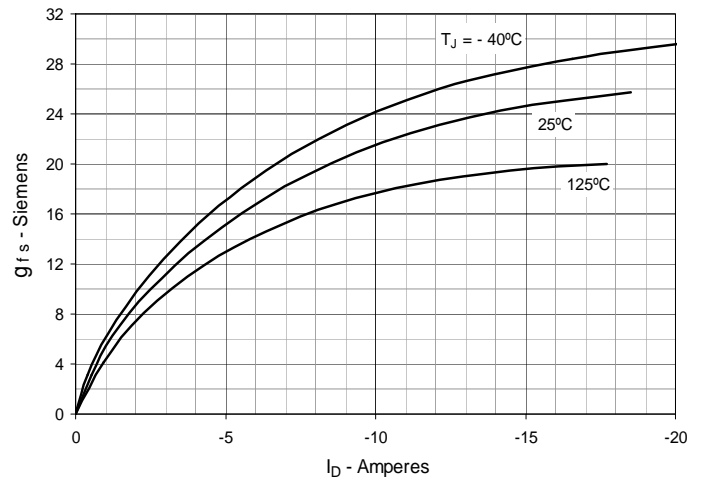

**Fig. 9. Forward Voltage Drop of Intrinsic Diode**

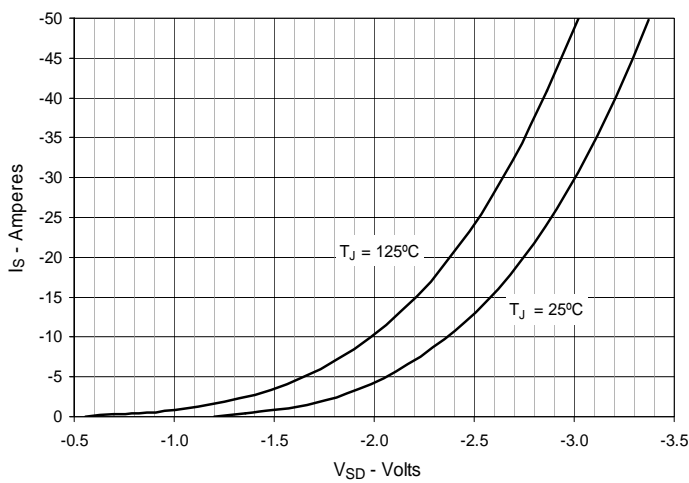

**Fig. 10. Gate Charge**

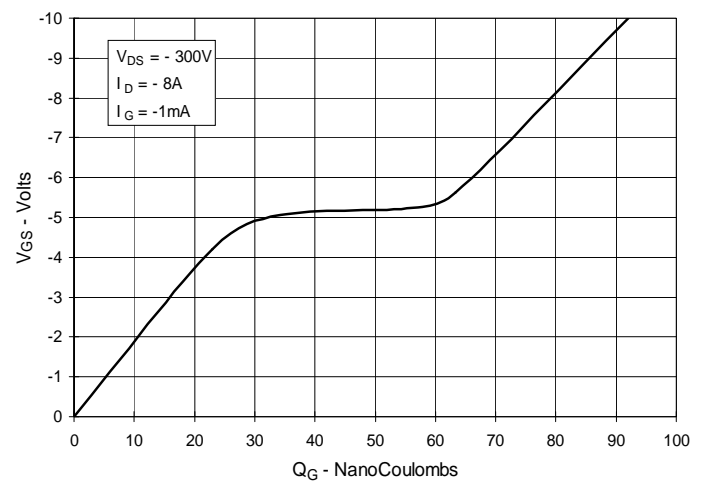

**Fig. 11. Capacitance**

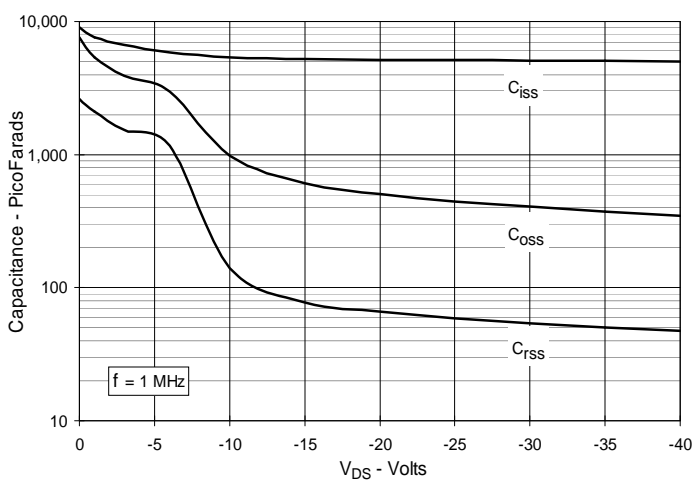

**Fig. 12. Forward-Bias Safe Operating Area**

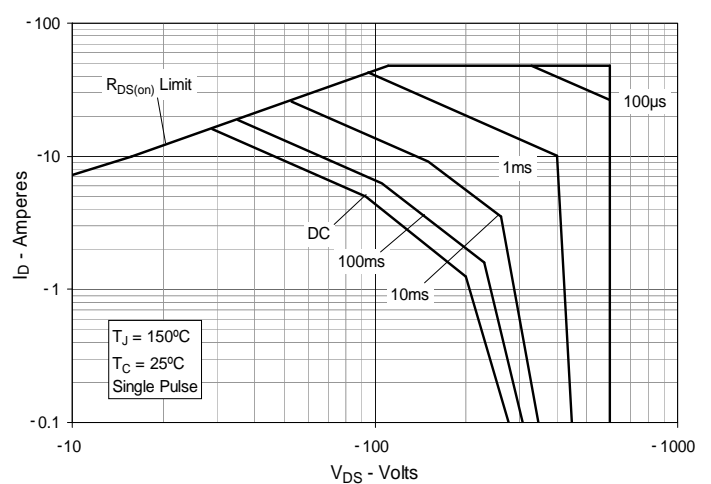
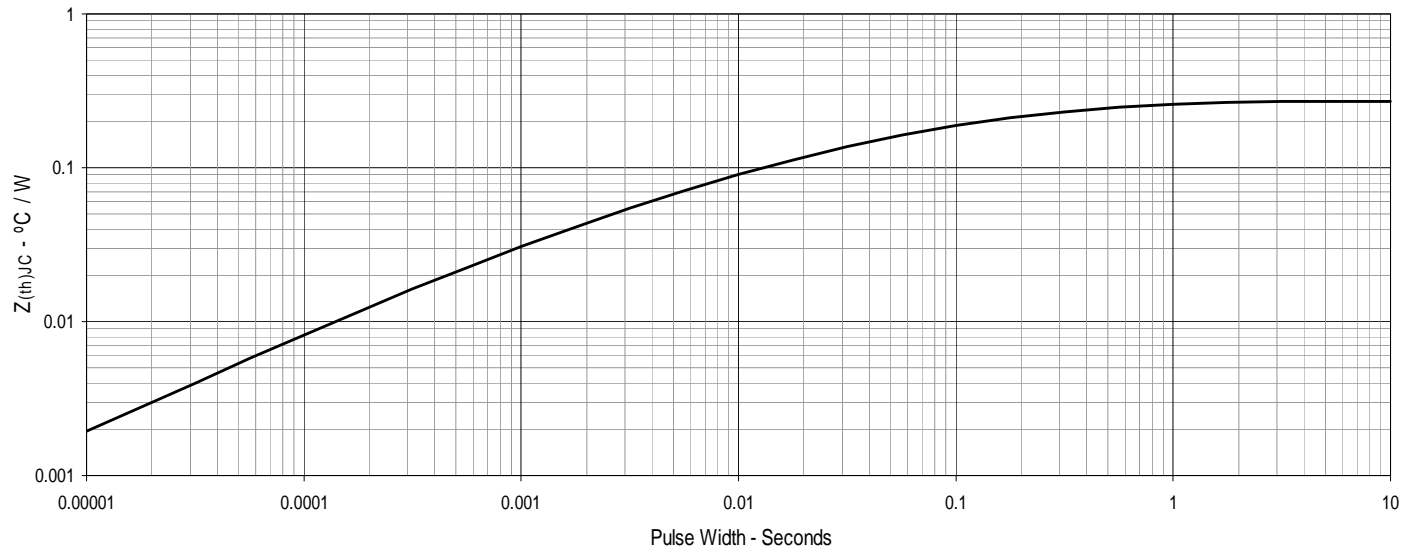

Fig. 13. Maximum Transient Thermal Impedance



# Mouser Electronics

Authorized Distributor

Click to View Pricing, Inventory, Delivery & Lifecycle Information:

[IXYS:](#)

[IXTH16P60P](#) [IXTT16P60P](#)