

Features

- High isolation 2W converter
- 3kVDC/1s and 4kVDC/1s basic isolation
- UL94V-0 package material
- Optional continuous short circuit protected
- Efficiency up to 84%
- Suitable for IGBT applications

Unregulated Converters

RKZ

**2 Watt
SIP7
Single and
Dual Output**



Description

The RKZ Series of 2W DC/DC Converters are certified to EN60950-1. This makes them suitable for high end industrial applications such as IGBT driver circuitry. The RKZ converters are pin-compatible with the RK and RH converter series, offering a simple way to upgrade a 1W high isolation supply to 2W.

Selection Guide

Part Number	nom. Input Voltage [VDC]	Output Voltage [VDC]	Output Current [mA]	Efficiency typ. ⁽¹⁾ [%]	max. Capacitive Load ⁽²⁾ [µF]
RKZ-xx05S ^(3,4)	5, 12, 24	5	400	82-84	1500
RKZ-xx12S ^(3,4)	5, 12, 24	12	168	82-87	330
RKZ-xx15S ^(3,4)	5, 12, 24	15	132	82-84	330
RKZ-xx05D ^(3,4)	5, 12, 24	±5	±200	70-83	±680
RKZ-xx12D ^(3,4)	5, 12, 24	±12	±84	82-84	±220
RKZ-xx15D ^(3,4)	5, 12, 24	±15	±66	82-88	±220
RKZ-xx1509D ^(3,4)	5, 12, 24	+15/-9	+67/-111	70-81	±330

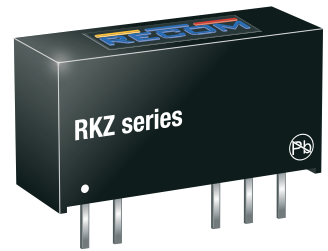

Notes:

- Note1: Efficiency is tested at nominal input and full load at +25°C ambient
 Note2: Max Cap Load is tested at nominal input and full resistive load and is defined as the capacitive load that will allow start up in under 1s without damage to the converter

IEC/EN60950-1 certified
 IEC/EN60601-1 certified
 EN55032 compliant

Model Numbering

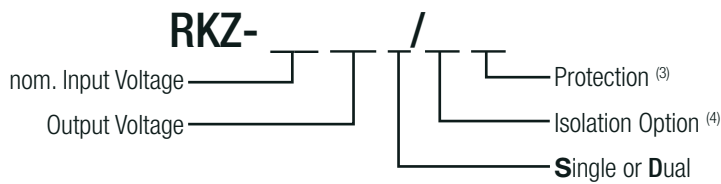

Notes:

- Note3: standard part is without Continuous Short Circuit Protection
 add suffix „/P“ for Continuous Short Circuit Protection
 Note4: add suffix „/H“ for 4kVDC/1s Isolation
 or add suffix „/HP“ for 4kVDC/1s Isolation and Continuous Short Circuit Protection

Ordering Examples:

RKZ-0515S/P: 5VDC Input Voltage, 15VDC Output Voltage, Single Output with continuous short circuit protection
 RKZ-0515D/HP: 5VDC Input Voltage, ±15VDC Output Voltage, Dual Output with continuous short circuit protection and 4kVDC/1s isolation



www.recom-power.com/eval-ref-boards

Specifications (measured @ Ta= 25°C, nom. Vin, full load and after warm-up unless otherwise stated)

BASIC CHARACTERISTICS

Parameter	Condition	Min.	Typ.	Max.
Internal Input Filter				capacitor
Input Voltage Range			±10%	
Minimum Load		0%		
Internal Operating Frequency	all others RKZ-xx1509D	20kHz 20kHz	50kHz 51kHz	85kHz
Output Ripple and Noise	20MHz BW			150mVp-p

Efficiency vs. Load

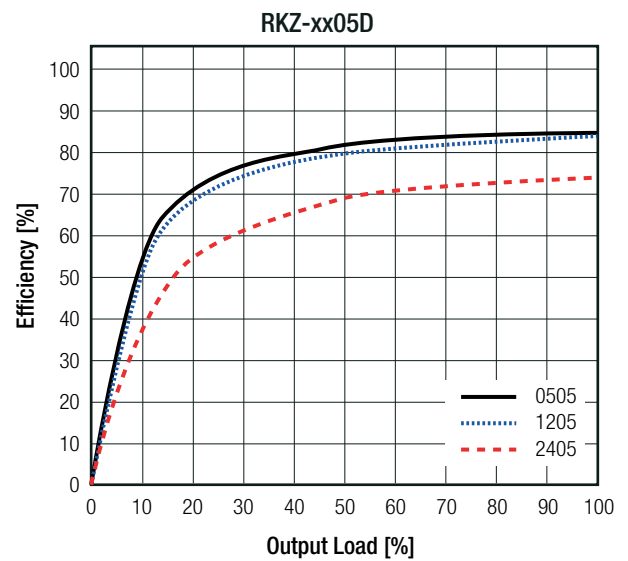
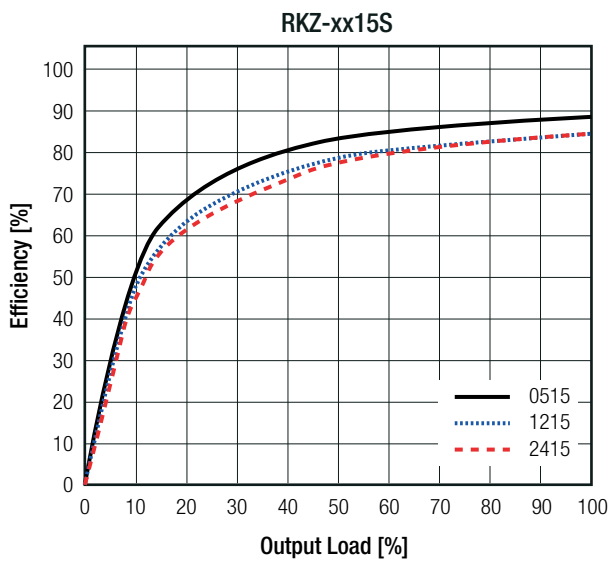
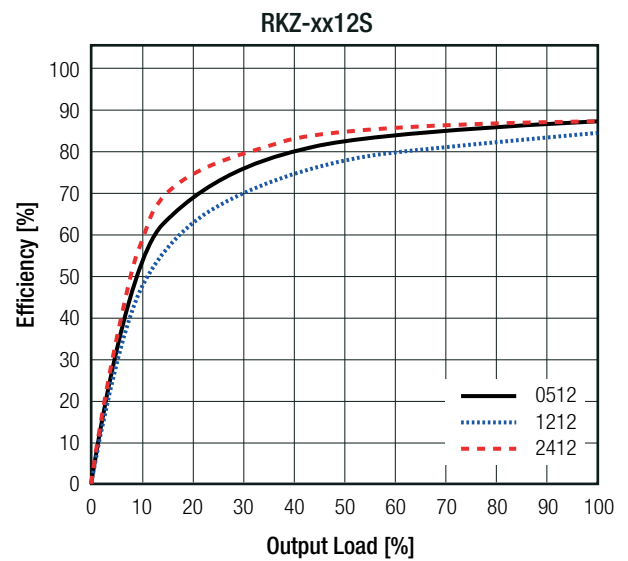
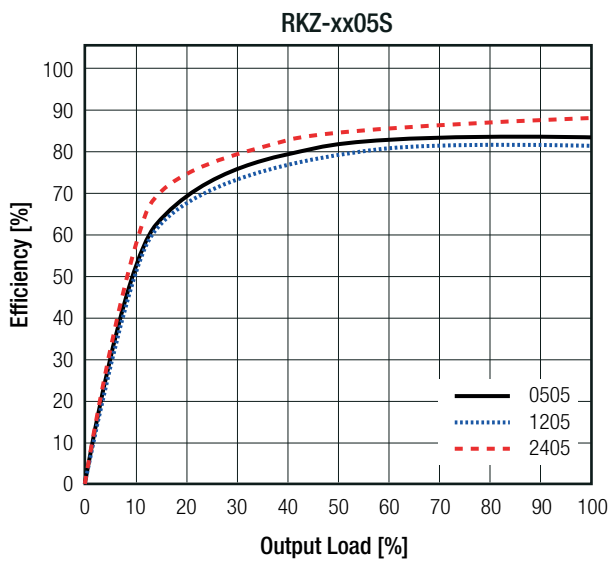

continued on next page

Specifications (measured @ Ta= 25°C, nom. Vin, full load and after warm-up unless otherwise stated)

Efficiency vs. Load

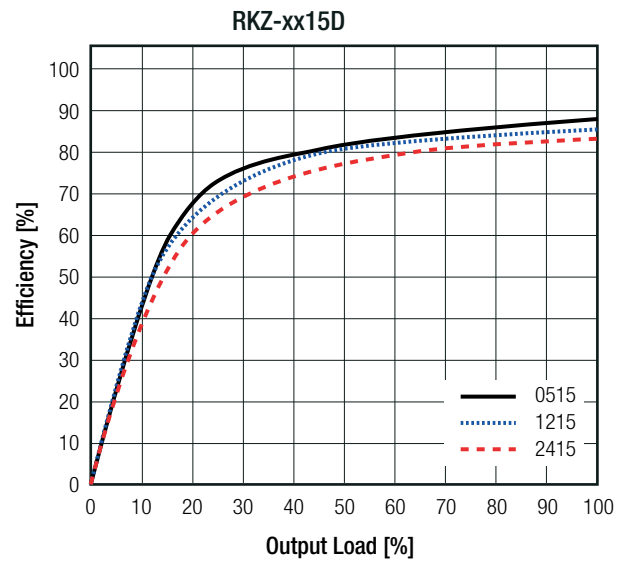
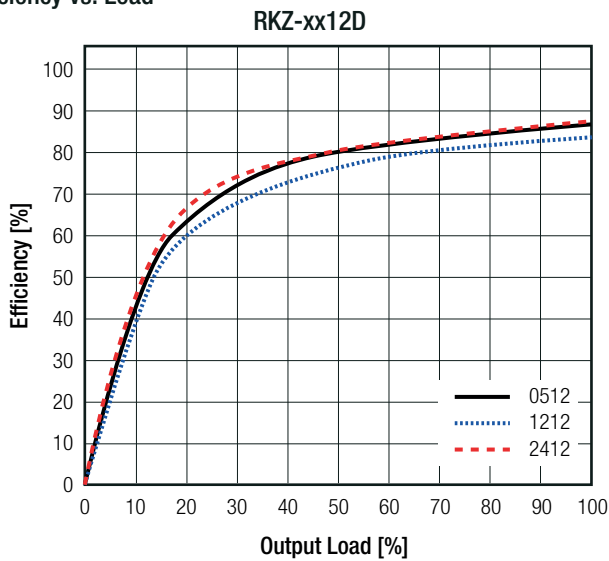

REGULATIONS

Parameter	Condition		Value
Output Accuracy			±5.0% max.
Line Regulation	low line to high line		±1.2% of 1.0% Vin typ.
Load Regulation ⁽⁵⁾	10% to 100% load	5Vout 12, 15, 24Vout and RKZ-xx1509D	15.0% max. 10.0% max.

Notes:

Note5: Operation below 10% load will not harm the converter, but specifications may not be met

Deviation vs. Load

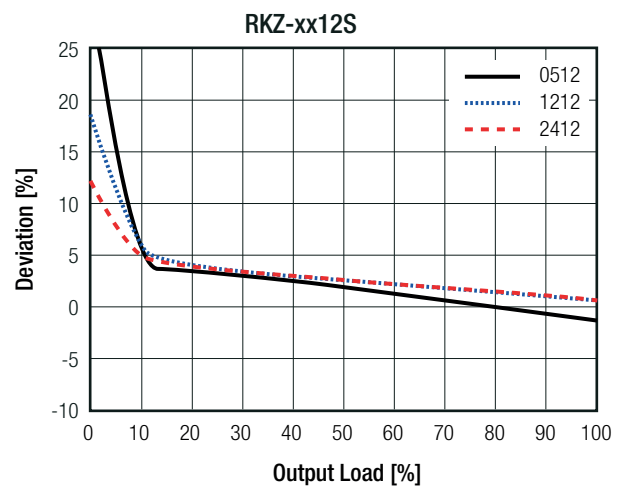
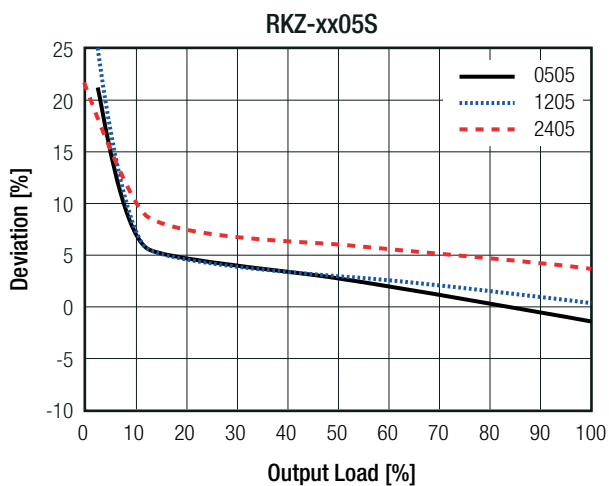

continued on next page

Specifications (measured @ Ta= 25°C, nom. Vin, full load and after warm-up unless otherwise stated)

Deviation vs. Load

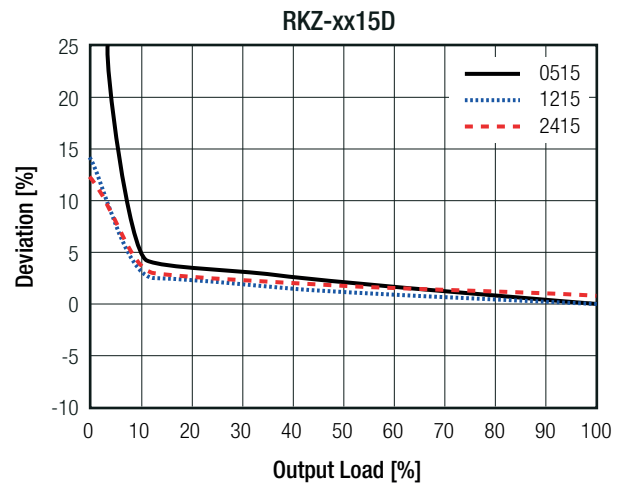
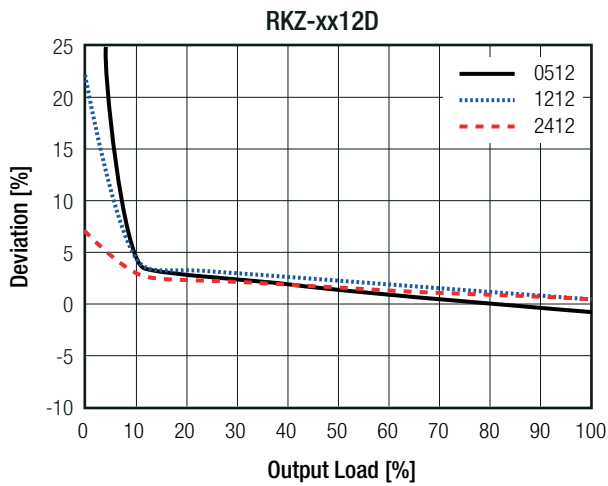
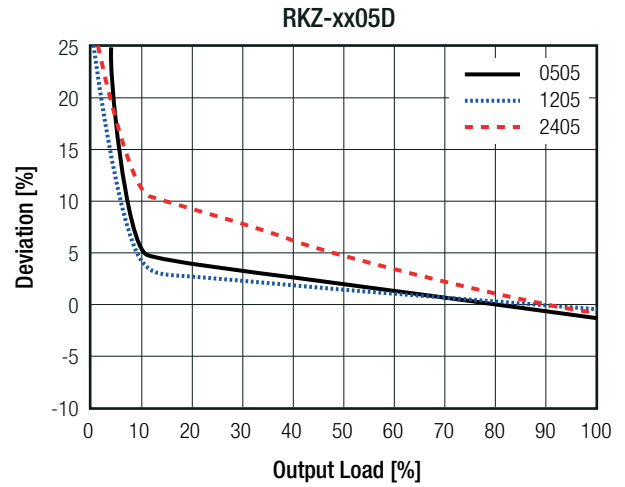
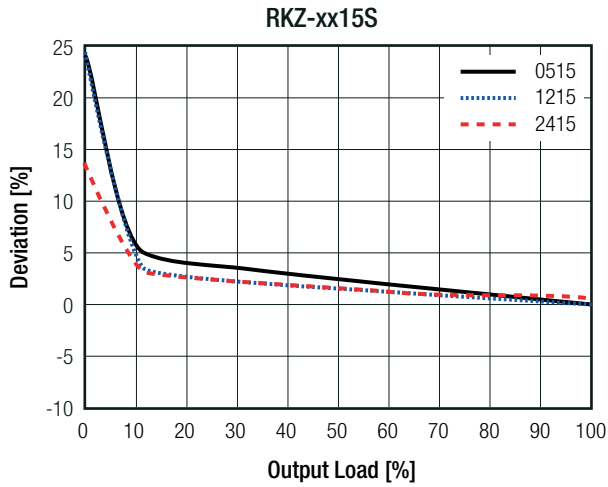

PROTECTIONS			
Parameter	Type		Value
Short Circuit Protection (SCP)	without suffix with suffix "/P"		1 second continuous
Isolation Voltage ⁽⁶⁾	I/P to O/P	without suffix	tested for 1 second rated for 1 minute 3kVDC 1.5kVAC / 60Hz
		with suffix "/H"	tested for 1 second rated for 1 minute 4kVDC 2kVAC / 60Hz
Isolation Resistance			10GΩ min.
Isolation Capacitance			120pF max.
Insulation Grade			basic (IEC/EN60950-1) functional (IEC/EN60601-1)
Notes:			
Note6: For repeat Hi-Pot testing, reduce the time and/or the test voltage			
Note7: Refer to local safety regulations if input over-current protection is required. Recommended fuse: slow blow type			

Specifications (measured @ Ta= 25°C, nom. Vin, full load and after warm-up unless otherwise stated)

ENVIRONMENTAL

Parameter	Condition		Value
Operating Temperature Range	full load @ free air convection (see graph)		-40°C to +85°C
Maximum Case Temperature			+110°C
Temperature Coefficient			±0.03%/K typ.
Thermal Impedance			40K/W typ.
Operating Altitude			3000m
Operating Humidity	non-condensing		95% RH max.
Pollution Degree			PD2
MTBF	according to MIL-HDBK-217F, G.B.	+25°C	18300 x 10 ³ hours
		+85°C	8070 x 10 ³ hours

Derating Graph
(@ free air convection)

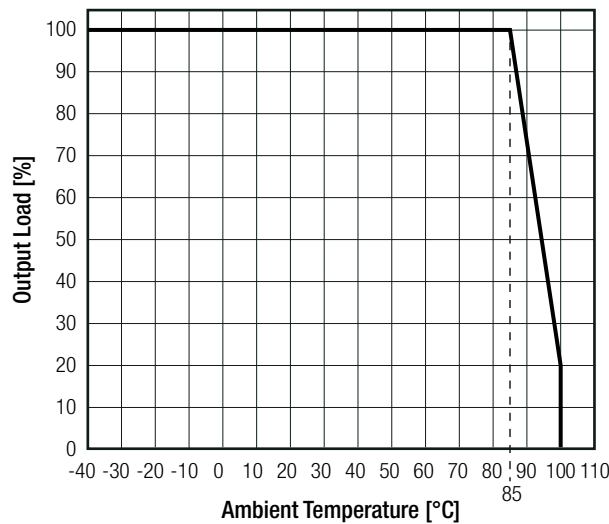

SAFETY AND CERTIFICATIONS

Certificate Type (Safety)	Report / File Number	Standard
Information Technology Equipment, General Requirements for Safety	SPCLVD1602031	IEC60950-1:2005, 2nd Edition + A2:2013 EN60950-1:2006 + A2:2013
Medical electrical equipment Part 1: General requirements for basic safety and essential performance	WD-SE-R-180676-A0 ^(®)	IEC60601-1:2005 + A1:2012, 3rd Edition EN60601-1:2006 + A1:2013 + A12:2014
EAC	RU-AT.49.09571	TP TC 004/2011
RoHS 2+		RoHS-2011/65/EU + AM-2015/863

EMC Compliance	Condition	Standard / Criterion
Electromagnetic compatibility of multimedia equipment - Emission requirements	with external filter (see filter suggestion below)	EN55032, Class B EN55032, Class A

Notes:

Note8: excluded +15/-9 version

continued on next page

Specifications (measured @ Ta= 25°C, nom. Vin, full load and after warm-up unless otherwise stated)

EMC Filter Suggestion according to EN55032

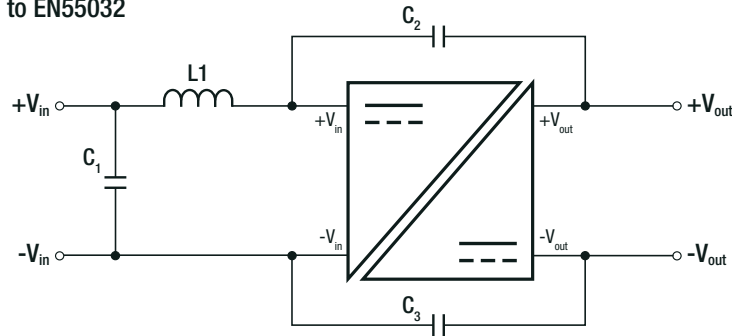

Component List Class A

MODEL	C1	L1	C2 (safety)	C3 (safety)
RKZ-0505S	10µF 100V MLCC	N/A	N/A	N/A
RKZ-1205S				
RKZ-2405S				

Component List Class B

MODEL	C1	L1	C2 (safety)	C3 (safety)
RKZ-0505S	10µF 100V MLCC	12µH choke RLS-126	470pF	1nF
RKZ-1205S		22µH choke RLS-226		
RKZ-2405S				

Notes:

Note9: Filter suggestions are valid for indicated part numbers only. For other part numbers, please contact RECOM tech support for advice

DIMENSION AND PHYSICAL CHARACTERISTICS

Parameter	Type	Value
Material	case potting PCB	non-conductive black plastic (UL94 V-0) epoxy, (UL94 V-0) FR4, (UL94 V-0)
Dimension (LxWxH)		19.65 x 7.05 x 10.2mm
Weight		2.8g typ.

Dimension Drawing (mm)

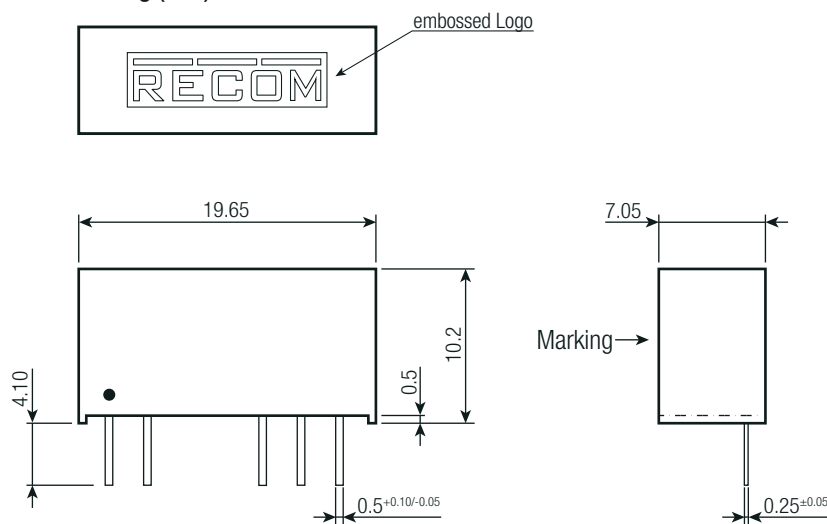

Pinning information

Pin #	Single	Dual
1	+Vin	+Vin
2	-Vin	-Vin
5	-Vout	-Vout
6	no pin	Com
7	+Vout	+Vout

Tolerance: xx.x= ±0.5mm
xx.xx= ±0.25mm

Recommended Footprint Details

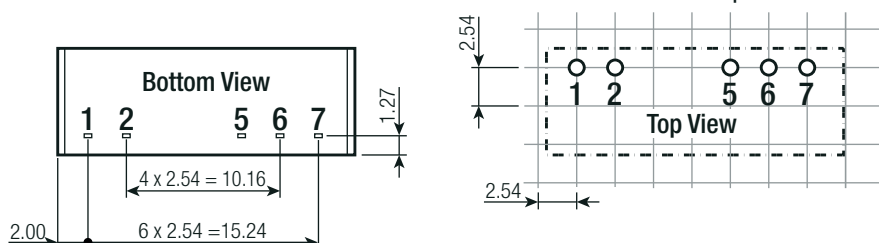

Specifications (measured @ Ta= 25°C, nom. Vin, full load and after warm-up unless otherwise stated)

INSTALLATION AND APPLICATION

IGBT Application Circuit

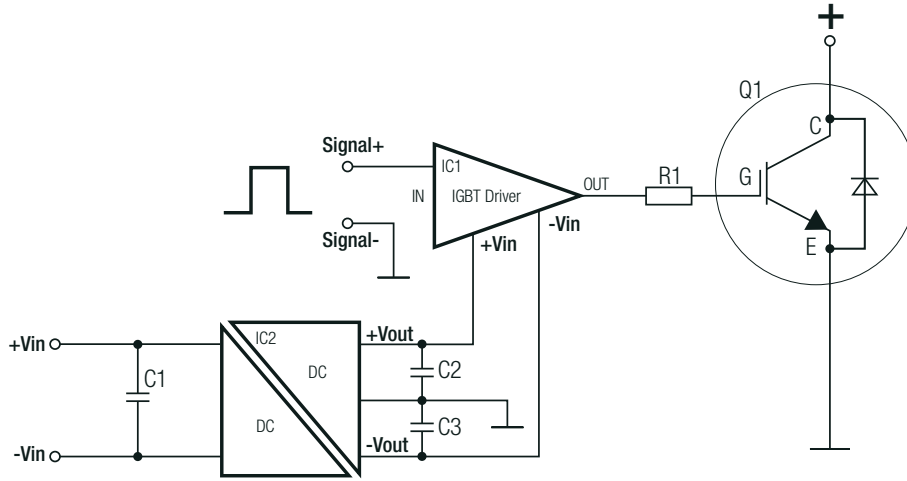

PACKAGING INFORMATION

Parameter	Type	Value
Packaging Dimension (LxWxH)	tube	520.0 x 16.0 x 9.0mm
Packaging Quantity	tube	25pcs
Storage Temperature Range		-55°C to +125°C
Storage Humidity	non-condensing	95% RH max.

The product information and specifications may be subject to changes even without prior written notice. The product has been designed for various applications; its suitability lies in the responsibility of each customer. The products are not authorized for use in safety-critical applications without RECOM's explicit written consent. A safety-critical application is an application where a failure may reasonably be expected to endanger or cause loss of life, inflict bodily harm or damage property. The applicant shall indemnify and hold harmless RECOM, its affiliated companies and its representatives against any damage claims in connection with the unauthorized use of RECOM products in such safety-critical applications.