

Cool MOS™ Power Transistor

Feature

- New revolutionary high voltage technology
- Worldwide best $R_{DS(on)}$ in TO 220
- Ultra low gate charge
- Periodic avalanche rated
- Extreme dv/dt rated
- High peak current capability
- Improved transconductance
- PG-TO-220-3-31: Fully isolated package (2500 VAC; 1 minute)
- Pb-free lead plating; RoHS compliant
- Qualified according to JEDEC⁰⁾ for target applications

| | | |
|---------------------|------|----------|
| $V_{DS} @ T_{jmax}$ | 650 | V |
| $R_{DS(on)}$ | 0.19 | Ω |
| I_D | 20.7 | A |

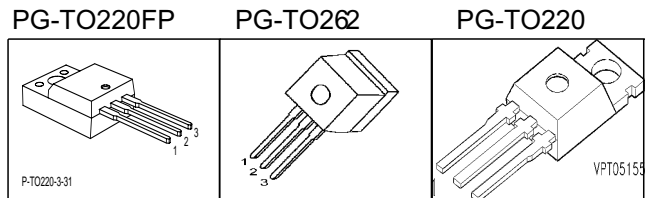

| Type | Package | Ordering Code | Marking |
|------------|------------|---------------|---------|
| SPP20N60C3 | PG-TO220 | Q67040-S4398 | 20N60C3 |
| SPI20N60C3 | PG-TO262 | Q67040-S4550 | 20N60C3 |
| SPA20N60C3 | PG-TO220FP | SP000216354 | 20N60C3 |

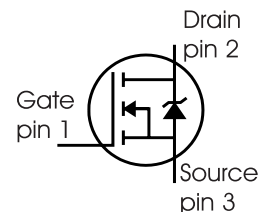

Maximum Ratings

| Parameter | Symbol | Value | | Unit |
|--|--------------------|--------------|--|------------------|
| | | SPP_I | SPA | |
| Continuous drain current $T_C = 25\text{ }^\circ\text{C}$ $T_C = 100\text{ }^\circ\text{C}$ | I_D | 20.7 13.1 | 20.7 ¹⁾ 13.1 ¹⁾ | A |
| Pulsed drain current, t_p limited by T_{jmax} | $I_D \text{ puls}$ | 62.1 | 62.1 | A |
| Avalanche energy, single pulse $I_D=10\text{A}, V_{DD}=50\text{V}$ | E_{AS} | 690 | 690 | mJ |
| Avalanche energy, repetitive t_{AR} limited by T_{jmax} ²⁾ $I_D=20\text{A}, V_{DD}=50\text{V}$ | E_{AR} | 1 | 1 | |
| Avalanche current, repetitive t_{AR} limited by T_{jmax} | I_{AR} | 20 | 20 | A |
| Gate source voltage static | V_{GS} | ± 20 | ± 20 | V |
| Gate source voltage AC ($f > 1\text{Hz}$) | V_{GS} | ± 30 | ± 30 | |
| Power dissipation, $T_C = 25\text{ }^\circ\text{C}$ | P_{tot} | 208 | 34.5 | W |
| Operating and storage temperature | T_j, T_{stg} | -55...+150 | | $^\circ\text{C}$ |
| Reverse diode dv/dt ⁷⁾ | dv/dt | 15 | | V/ns |

Maximum Ratings

| Parameter | Symbol | Value | Unit |
|---|---------|-------|------|
| Drain Source voltage slope $V_{DS} = 480\text{ V}, I_D = 20.7\text{ A}, T_j = 125\text{ °C}$ | dv/dt | 50 | V/ns |

Thermal Characteristics

| Parameter | Symbol | Values | | | Unit |
|---|----------------------|--------|------|------|------|
| | | min. | typ. | max. | |
| Thermal resistance, junction - case | R_{thJC} | - | - | 0.6 | K/W |
| Thermal resistance, junction - case, FullPAK | $R_{thJC\text{ FP}}$ | - | - | 3.6 | |
| Thermal resistance, junction - ambient, leaded | R_{thJA} | - | - | 62 | |
| Thermal resistance, junction - ambient, FullPAK | $R_{thJA\text{ FP}}$ | - | - | 80 | |
| SMD version, device on PCB: @ min. footprint @ 6 cm ² cooling area ³⁾ | R_{thJA} | - | - | 62 | |
| Soldering temperature, wavesoldering 1.6 mm (0.063 in.) from case for 10s ⁴⁾ | T_{sold} | - | - | 260 | °C |

Electrical Characteristics, at $T_j=25\text{ °C}$ unless otherwise specified

| Parameter | Symbol | Conditions | Values | | | Unit |
|--|---------------|--|--------|------|------|---------------|
| | | | min. | typ. | max. | |
| Drain-source breakdown voltage | $V_{(BR)DSS}$ | $V_{GS}=0\text{V}, I_D=0.25\text{mA}$ | 600 | - | - | V |
| Drain-Source avalanche breakdown voltage | $V_{(BR)DS}$ | $V_{GS}=0\text{V}, I_D=20\text{A}$ | - | 700 | - | |
| Gate threshold voltage | $V_{GS(th)}$ | $I_D=1000\mu\text{A}, V_{GS}=V_{DS}$ | 2.1 | 3 | 3.9 | |
| Zero gate voltage drain current | I_{DSS} | $V_{DS}=600\text{V}, V_{GS}=0\text{V},$ $T_j=25\text{ °C}$ $T_j=150\text{ °C}$ | - | 0.1 | 1 | μA |
| Gate-source leakage current | I_{GSS} | $V_{GS}=30\text{V}, V_{DS}=0\text{V}$ | - | - | 100 | |
| Drain-source on-state resistance | $R_{DS(on)}$ | $V_{GS}=10\text{V}, I_D=13.1\text{A}$ $T_j=25\text{ °C}$ $T_j=150\text{ °C}$ | - | 0.16 | 0.19 | Ω |
| Gate input resistance | R_G | $f=1\text{MHz}, \text{open drain}$ | - | 0.54 | - | |

Electrical Characteristics

| Parameter | Symbol | Conditions | Values | | | Unit |
|---|--------------|--|--------|------|------|------|
| | | | min. | typ. | max. | |
| Transconductance | g_{fs} | $V_{DS} \geq 2 \cdot I_D \cdot R_{DS(on)max}$, $I_D = 13.1A$ | - | 17.5 | - | S |
| Input capacitance | C_{iss} | $V_{GS} = 0V$, $V_{DS} = 25V$, | - | 2400 | - | pF |
| Output capacitance | C_{oss} | $f = 1MHz$ | - | 780 | - | |
| Reverse transfer capacitance | C_{rss} | | - | 50 | - | |
| Effective output capacitance, ⁵⁾ energy related | $C_{o(er)}$ | $V_{GS} = 0V$, $V_{DS} = 0V$ to 480V | - | 83 | - | |
| Effective output capacitance, ⁶⁾ time related | $C_{o(tr)}$ | | - | 160 | - | |
| Turn-on delay time | $t_{d(on)}$ | $V_{DD} = 380V$, $V_{GS} = 0/13V$, $I_D = 20.7A$, $R_G = 3.6\Omega$, $T_J = 125^\circ C$ | - | 10 | - | ns |
| Rise time | t_r | | - | 5 | - | |
| Turn-off delay time | $t_{d(off)}$ | | - | 67 | 100 | |
| Fall time | t_f | | - | 4.5 | 12 | |

Gate Charge Characteristics

| | | | | | | |
|-----------------------|-----------------|--|---|-----|-----|----|
| Gate to source charge | Q_{gs} | $V_{DD} = 480V$, $I_D = 20.7A$ | - | 11 | - | nC |
| Gate to drain charge | Q_{gd} | | - | 33 | - | |
| Gate charge total | Q_g | $V_{DD} = 480V$, $I_D = 20.7A$, $V_{GS} = 0$ to 10V | - | 87 | 114 | |
| Gate plateau voltage | $V_{(plateau)}$ | $V_{DD} = 480V$, $I_D = 20.7A$ | - | 5.5 | - | V |

⁰J-STD20 and JESD22

¹Limited only by maximum temperature

²Repetitive avalanche causes additional power losses that can be calculated as $P_{AV} = E_{AR} \cdot f$.

³Device on 40mm*40mm*1.5mm epoxy PCB FR4 with 6cm² (one layer, 70 μm thick) copper area for drain connection. PCB is vertical without blown air.

⁴Soldering temperature for TO-263: 220°C, reflow

⁵ $C_{o(er)}$ is a fixed capacitance that gives the same stored energy as C_{oss} while V_{DS} is rising from 0 to 80% V_{DSS} .

⁶ $C_{o(tr)}$ is a fixed capacitance that gives the same charging time as C_{oss} while V_{DS} is rising from 0 to 80% V_{DSS} .

⁷ $I_{SD} \leq I_D$, $di/dt \leq 400A/\mu s$, $V_{DClink} = 400V$, $V_{peak} < V_{BR, DSS}$, $T_J < T_{J,max}$. Identical low-side and high-side switch.

Electrical Characteristics

| Parameter | Symbol | Conditions | Values | | | Unit |
|---|--------------|-----------------------------------|--------|------|------|------------------------|
| | | | min. | typ. | max. | |
| Inverse diode continuous forward current | I_S | $T_C=25^\circ\text{C}$ | - | - | 20.7 | A |
| Inverse diode direct current, pulsed | I_{SM} | | - | - | 62.1 | |
| Inverse diode forward voltage | V_{SD} | $V_{GS}=0\text{V}, I_F=I_S$ | - | 1 | 1.2 | V |
| Reverse recovery time | t_{rr} | $V_R=480\text{V}, I_F=I_S,$ | - | 500 | 800 | ns |
| Reverse recovery charge | Q_{rr} | $di_F/dt=100\text{A}/\mu\text{s}$ | - | 11 | - | μC |
| Peak reverse recovery current | I_{rrm} | | - | 70 | - | A |
| Peak rate of fall of reverse recovery current | di_{rr}/dt | $T_j=25^\circ\text{C}$ | - | 1400 | - | $\text{A}/\mu\text{s}$ |

Typical Transient Thermal Characteristics

| Symbol | Value | | Unit | Symbol | Value | | Unit |
|-----------|---------|---------|------|-----------|-----------|-----------|------|
| | SPP_I | SPA | | | SPP_I | SPA | |
| R_{th1} | 0.00769 | 0.00769 | K/W | C_{th1} | 0.0003763 | 0.0003763 | Ws/K |
| R_{th2} | 0.015 | 0.015 | | C_{th2} | 0.001411 | 0.001411 | |
| R_{th3} | 0.029 | 0.029 | | C_{th3} | 0.001931 | 0.001931 | |
| R_{th4} | 0.114 | 0.163 | | C_{th4} | 0.005297 | 0.005297 | |
| R_{th5} | 0.136 | 0.323 | | C_{th5} | 0.012 | 0.008453 | |
| R_{th6} | 0.059 | 2.526 | | C_{th6} | 0.091 | 0.412 | |

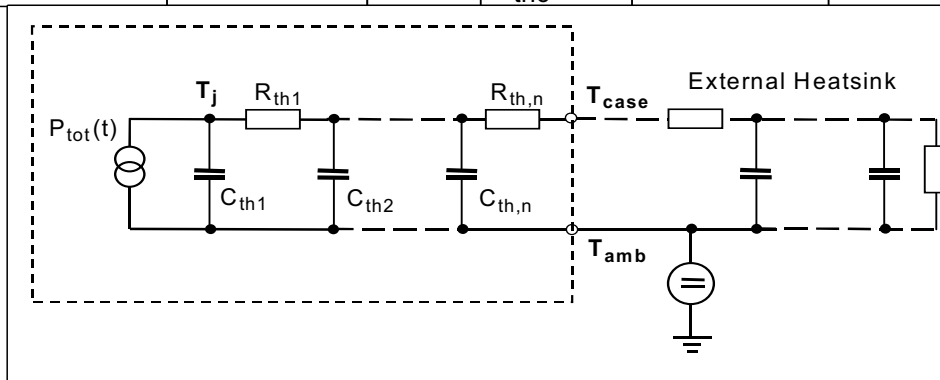

1 Power dissipation

$P_{tot} = f(T_C)$

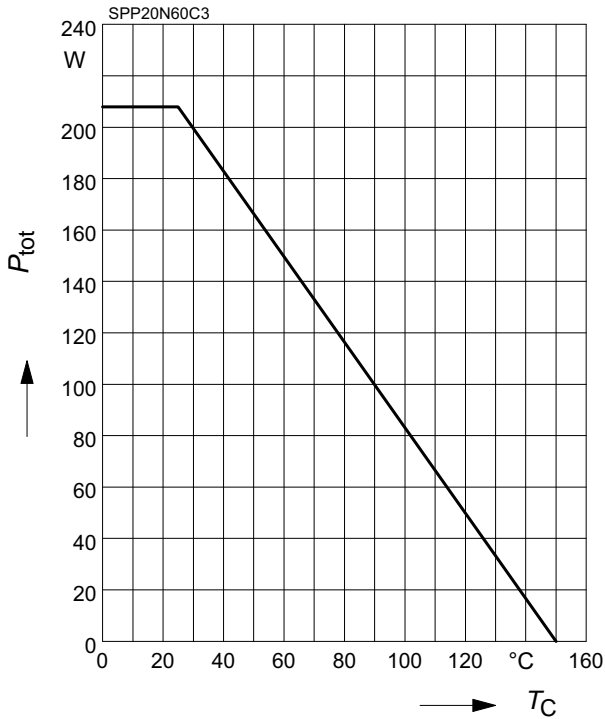

2 Power dissipation FullPAK

$P_{tot} = f(T_C)$

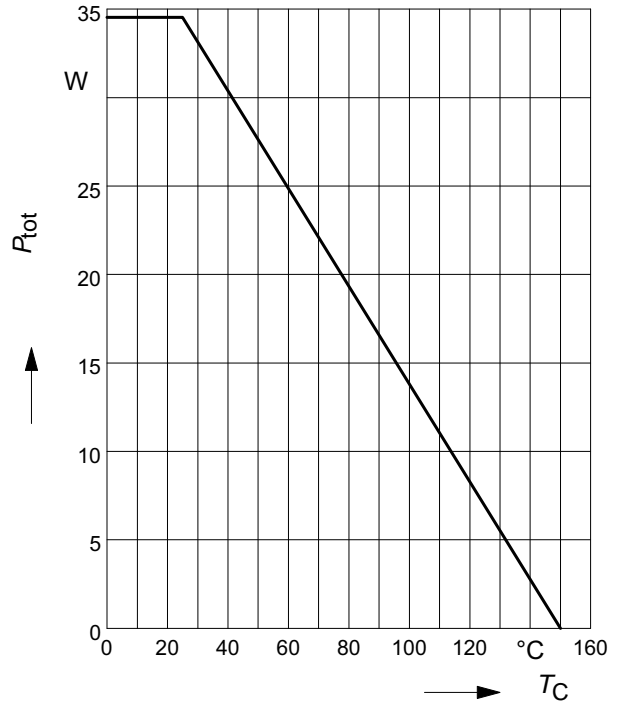

3 Safe operating area

$I_D = f(V_{DS})$

parameter : $D = 0$, $T_C = 25^\circ\text{C}$

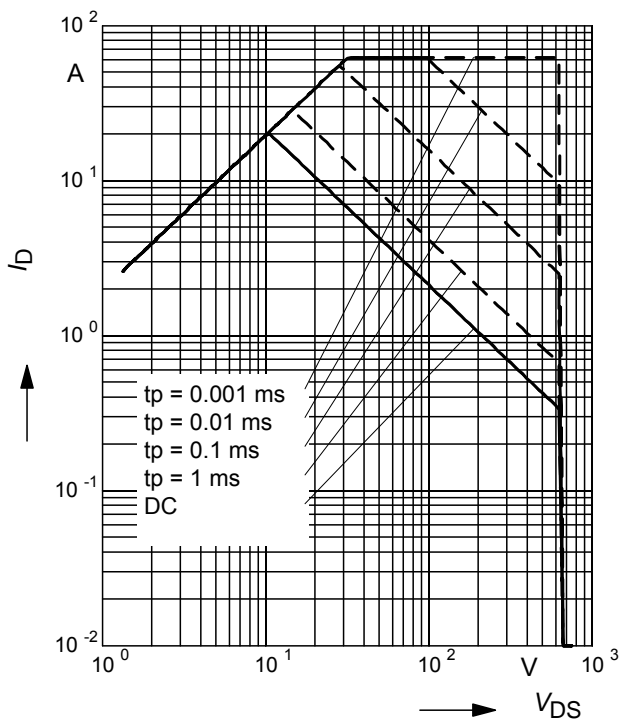

4 Safe operating area FullPAK

$I_D = f(V_{DS})$

parameter: $D = 0$, $T_C = 25^\circ\text{C}$

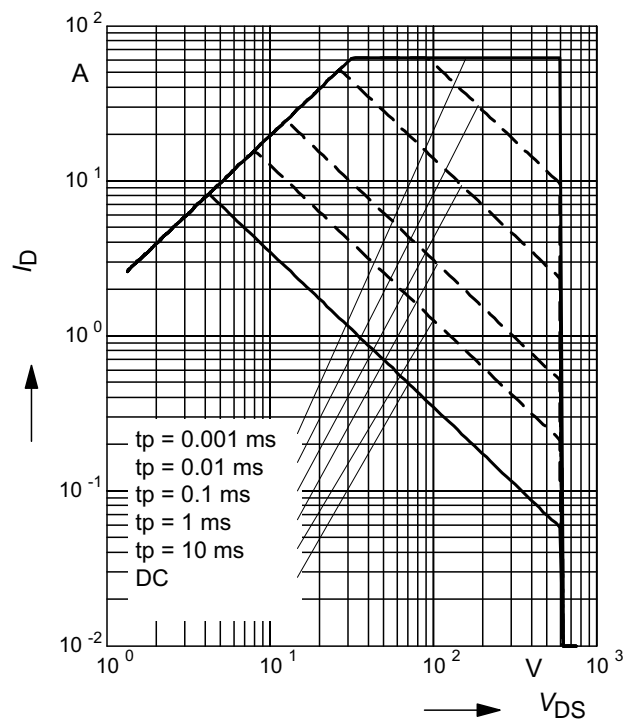

5 Transient thermal impedance

$Z_{thJC} = f(t_p)$

parameter: $D = t_p/T$

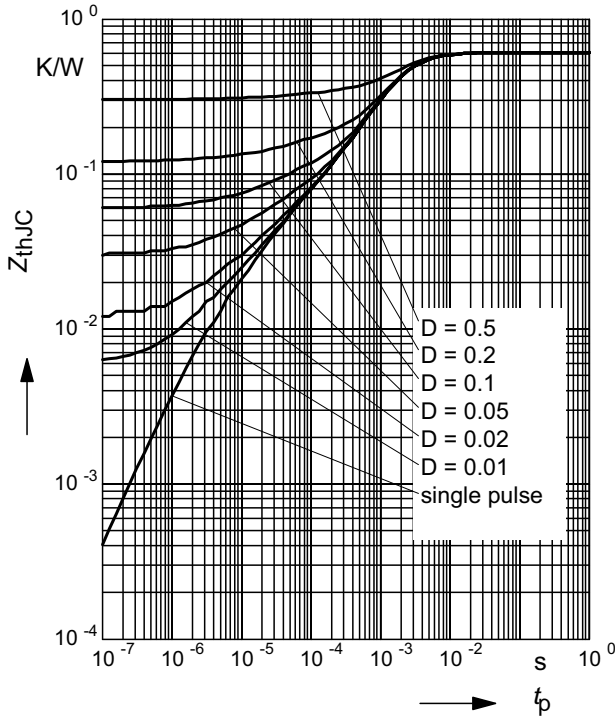

6 Transient thermal impedance FullPAK

$Z_{thJC} = f(t_p)$

parameter: $D = t_p/t$

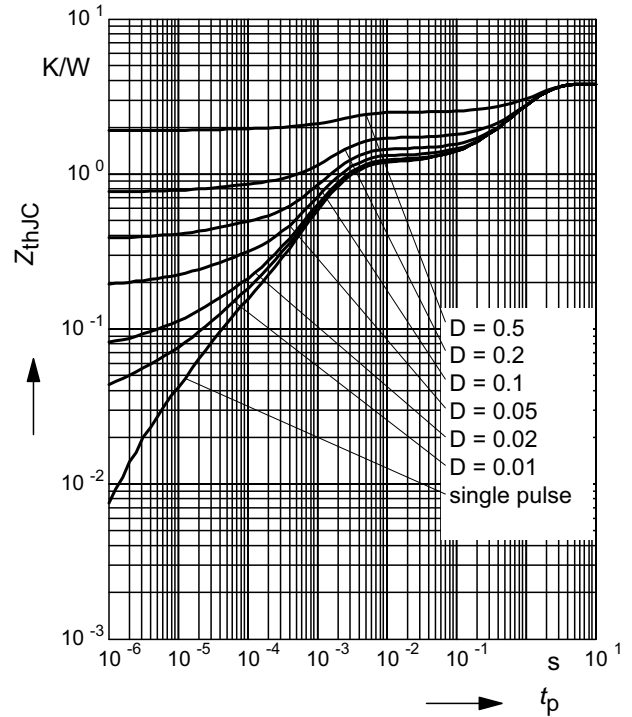

7 Typ. output characteristic

$I_D = f(V_{DS}); T_j = 25^\circ C$

parameter: $t_p = 10 \mu s, V_{GS}$

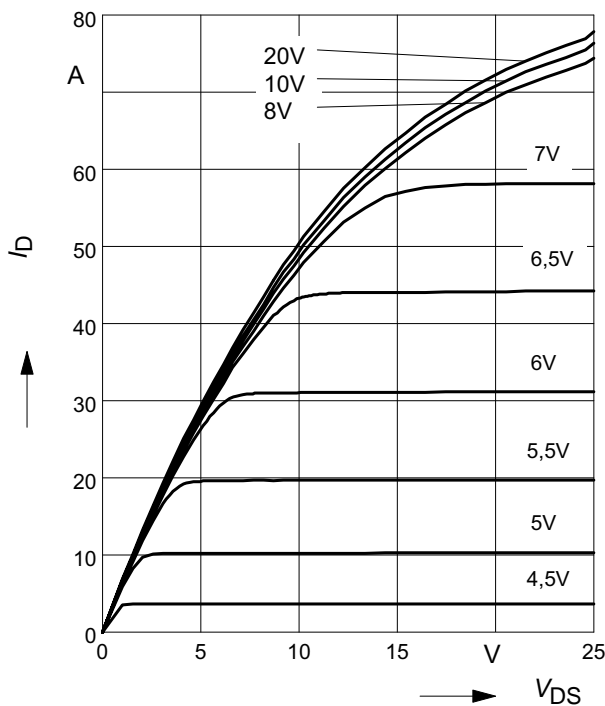

8 Typ. output characteristic

$I_D = f(V_{DS}); T_j = 150^\circ C$

parameter: $t_p = 10 \mu s, V_{GS}$

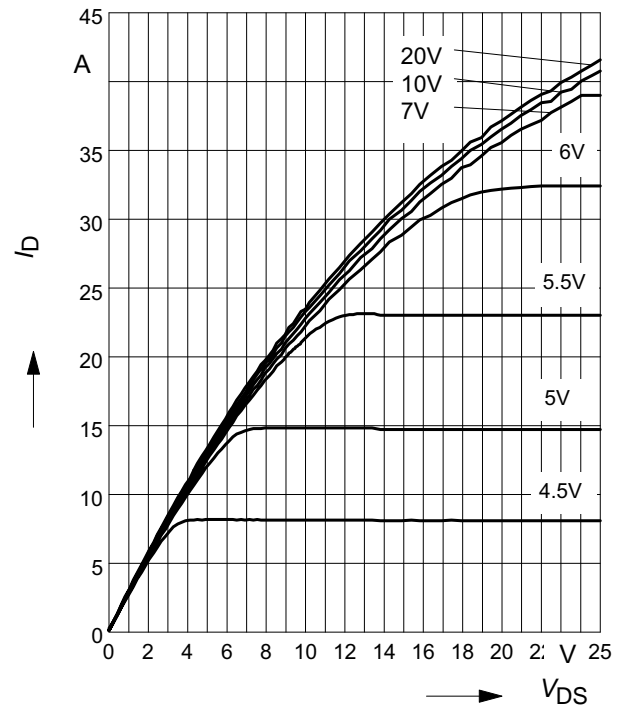

9 Typ. drain-source on resistance

$$R_{DS(on)} = f(I_D)$$

parameter: $T_j = 150^\circ\text{C}$, V_{GS}

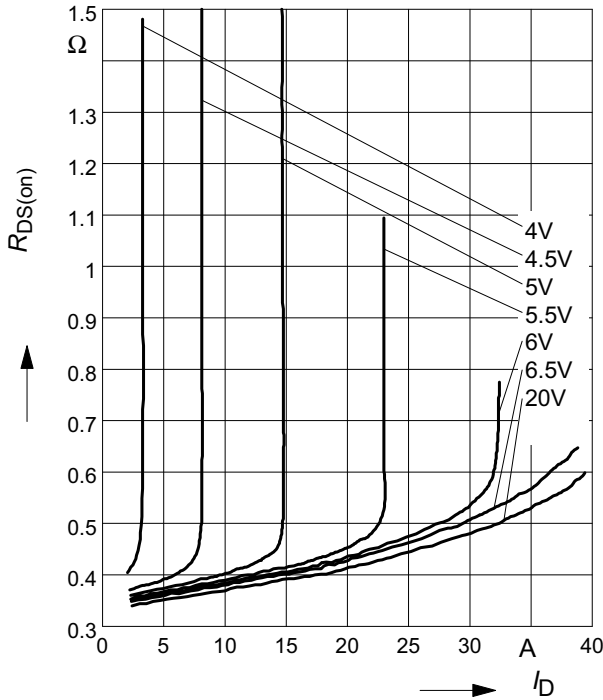

10 Drain-source on-state resistance

$$R_{DS(on)} = f(T_j)$$

parameter: $I_D = 13.1\text{ A}$, $V_{GS} = 10\text{ V}$

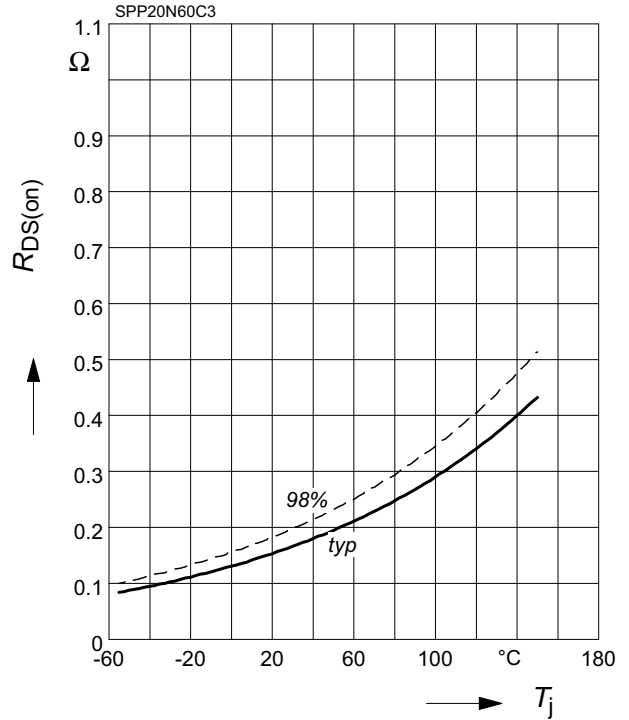

11 Typ. transfer characteristics

$$I_D = f(V_{GS}); V_{DS} \geq 2 \times I_D \times R_{DS(on)max}$$

parameter: $t_p = 10\ \mu\text{s}$

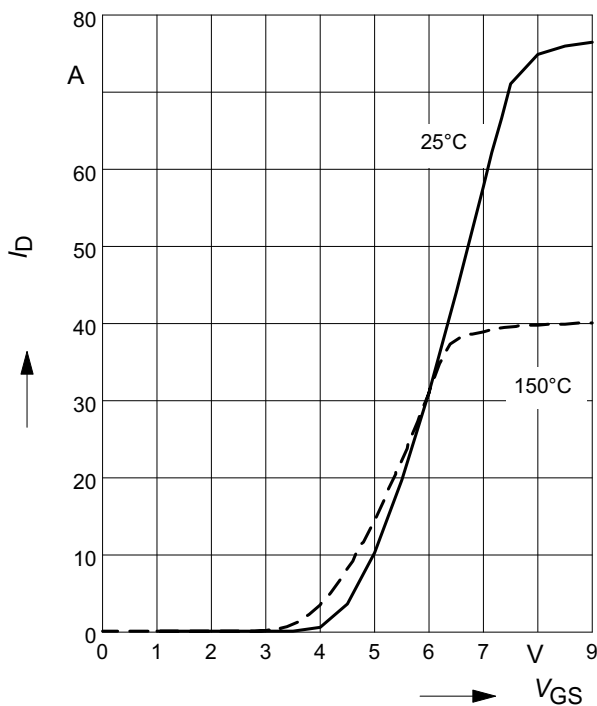

12 Typ. gate charge

$$V_{GS} = f(Q_{Gate})$$

parameter: $I_D = 20.7\text{ A pulsed}$

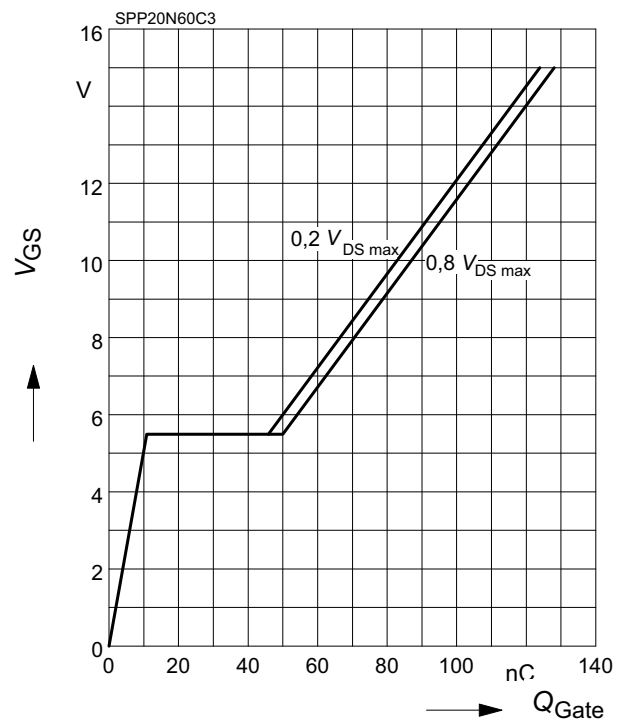

13 Forward characteristics of body diode

$I_F = f(V_{SD})$

parameter: T_j , $t_p = 10 \mu s$

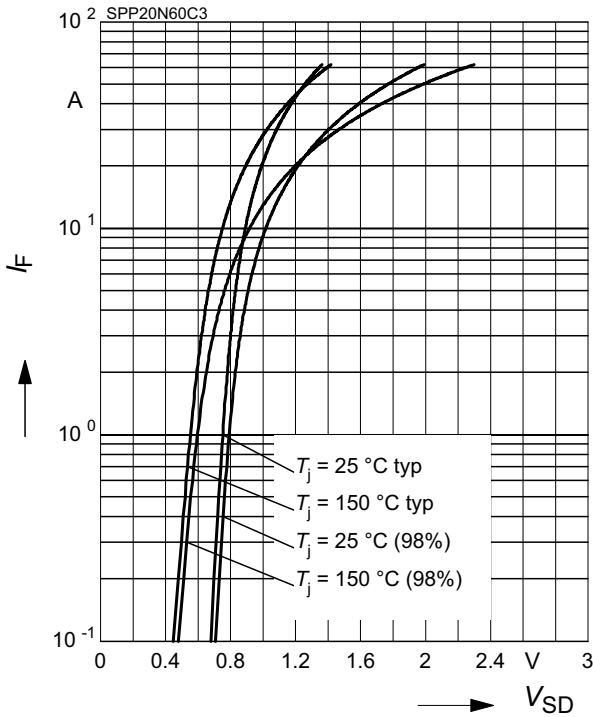

14 Typ. switching time

$t = f(I_D)$, inductive load, $T_j = 125^\circ C$

par.: $V_{DS} = 380V$, $V_{GS} = 0/+13V$, $R_G = 3.6\Omega$

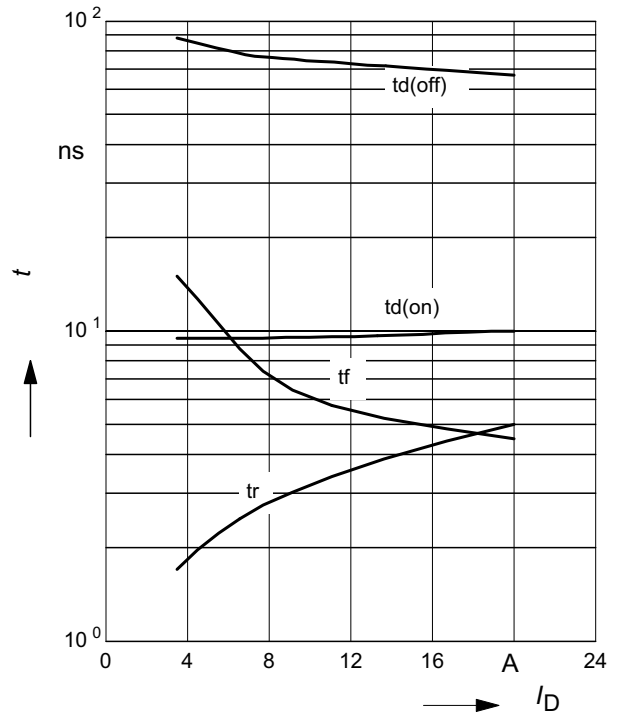

15 Typ. switching time

$t = f(R_G)$, inductive load, $T_j = 125^\circ C$

par.: $V_{DS} = 380V$, $V_{GS} = 0/+13V$, $I_D = 20.7 A$

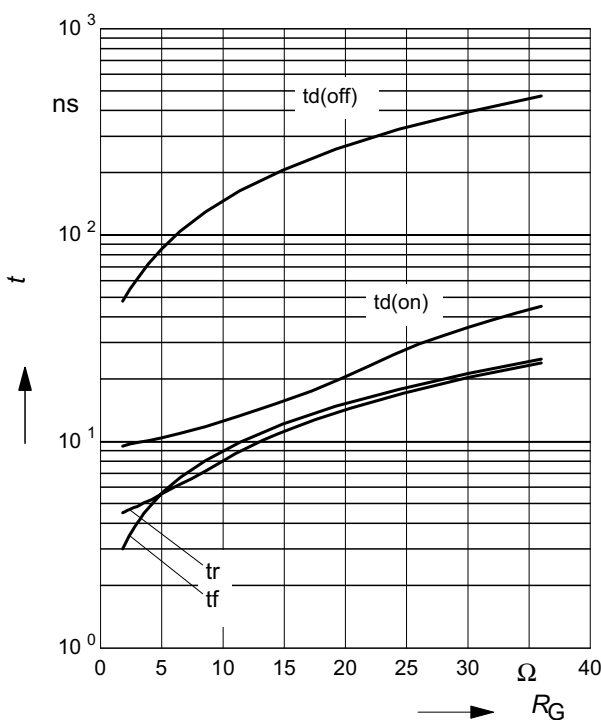

16 Typ. drain current slope

$di/dt = f(R_G)$, inductive load, $T_j = 125^\circ C$

par.: $V_{DS} = 380V$, $V_{GS} = 0/+13V$, $I_D = 20.7A$

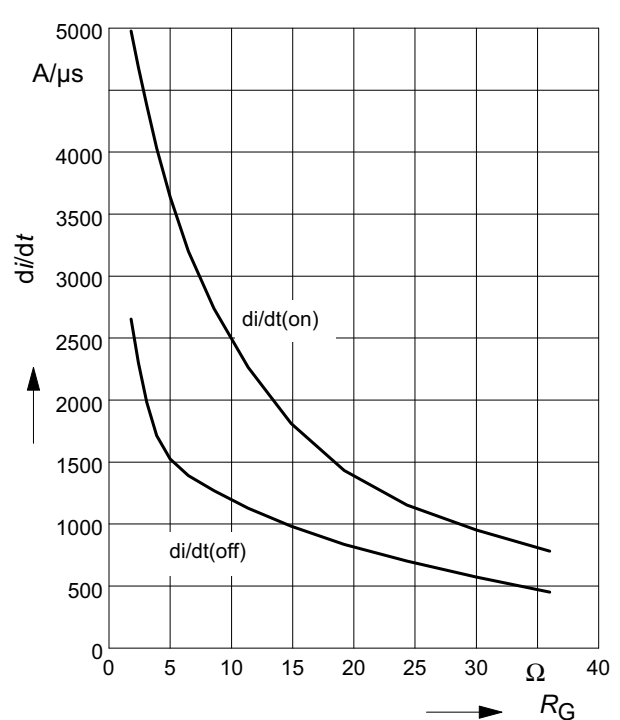

17 Typ. drain source voltage slope

$dv/dt = f(R_G)$, inductive load, $T_j = 125^\circ\text{C}$
par.: $V_{DS}=380\text{V}$, $V_{GS}=0/+13\text{V}$, $I_D=20.7\text{A}$

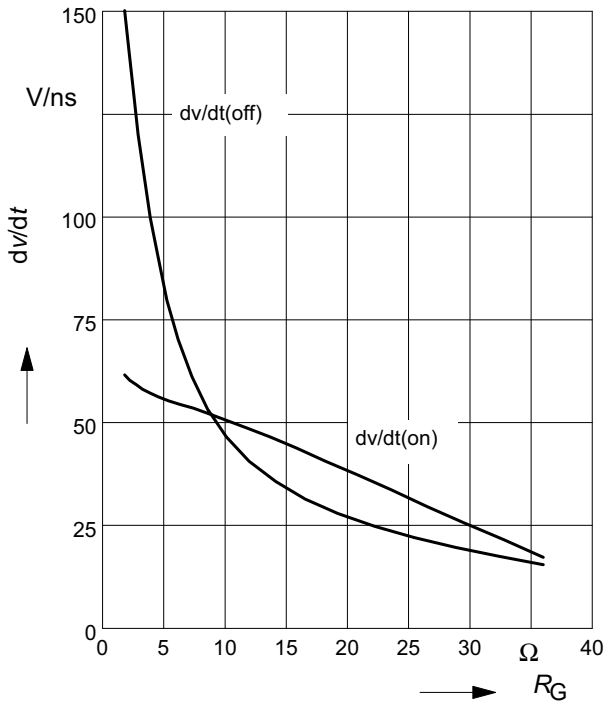

18 Typ. switching losses

$E = f(I_D)$, inductive load, $T_j=125^\circ\text{C}$
par.: $V_{DS}=380\text{V}$, $V_{GS}=0/+13\text{V}$, $R_G=3.6\Omega$

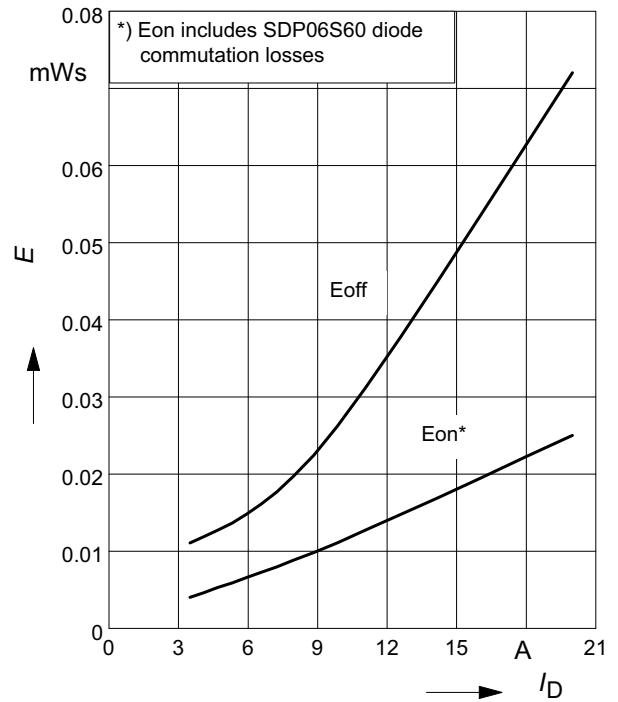

19 Typ. switching losses

$E = f(R_G)$, inductive load, $T_j=125^\circ\text{C}$
par.: $V_{DS}=380\text{V}$, $V_{GS}=0/+13\text{V}$, $I_D=20.7\text{A}$

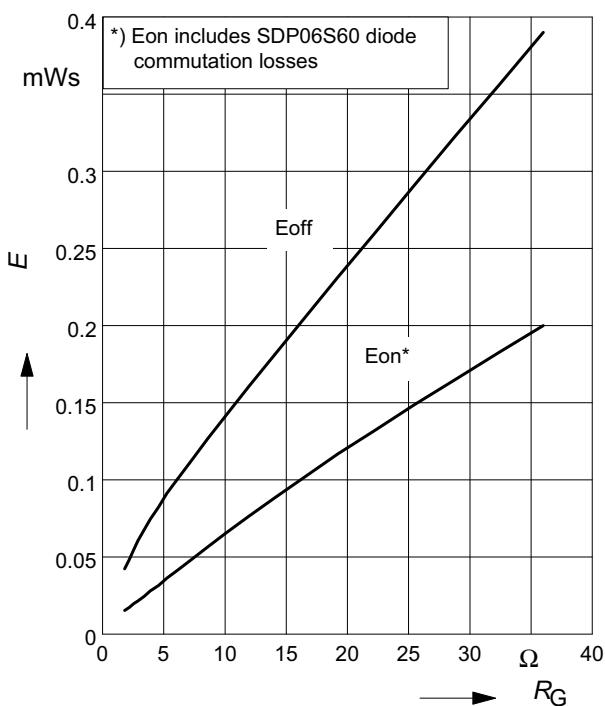

20 Avalanche SOA

$I_{AR} = f(t_{AR})$
par.: $T_j \leq 150^\circ\text{C}$

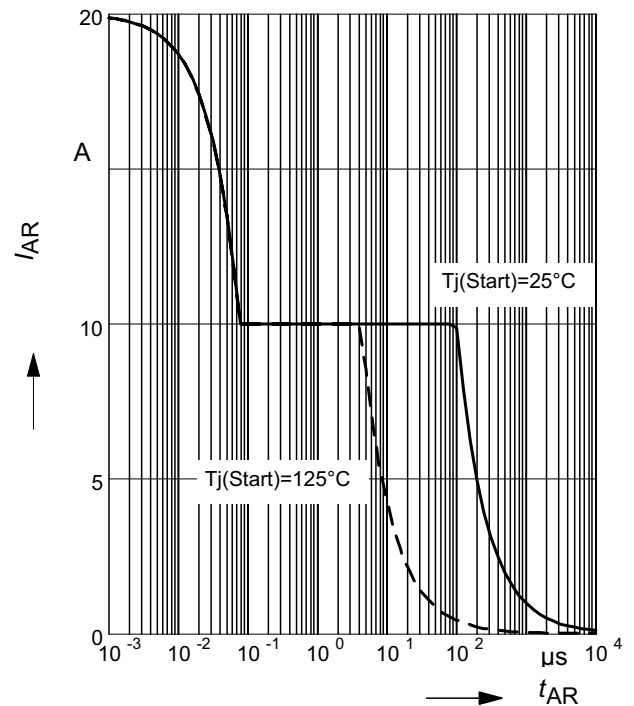

21 Avalanche energy

$$E_{AS} = f(T_j)$$

par.: $I_D = 10\text{ A}$, $V_{DD} = 50\text{ V}$

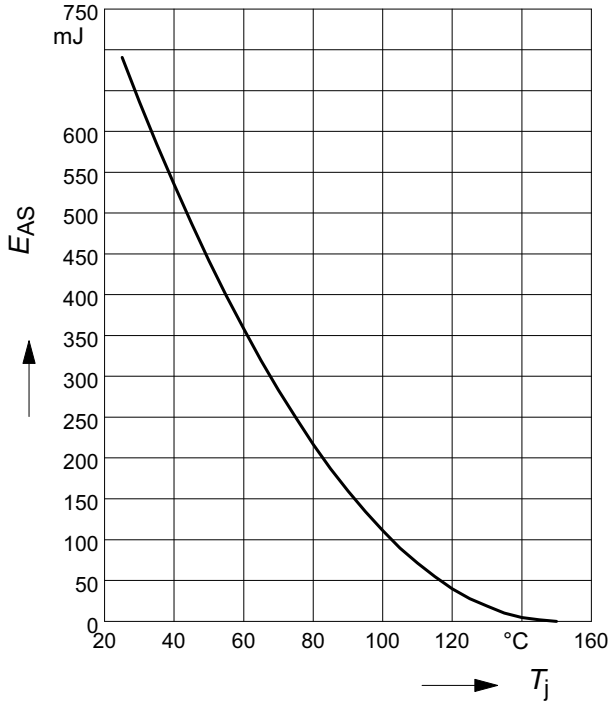

22 Drain-source breakdown voltage

$$V_{(BR)DSS} = f(T_j)$$

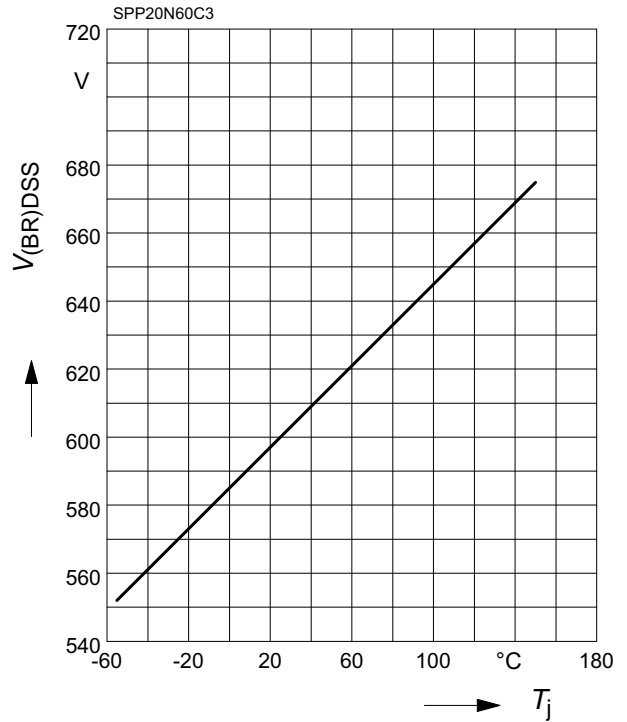

23 Avalanche power losses

$$P_{AR} = f(f)$$

parameter: $E_{AR} = 1\text{ mJ}$

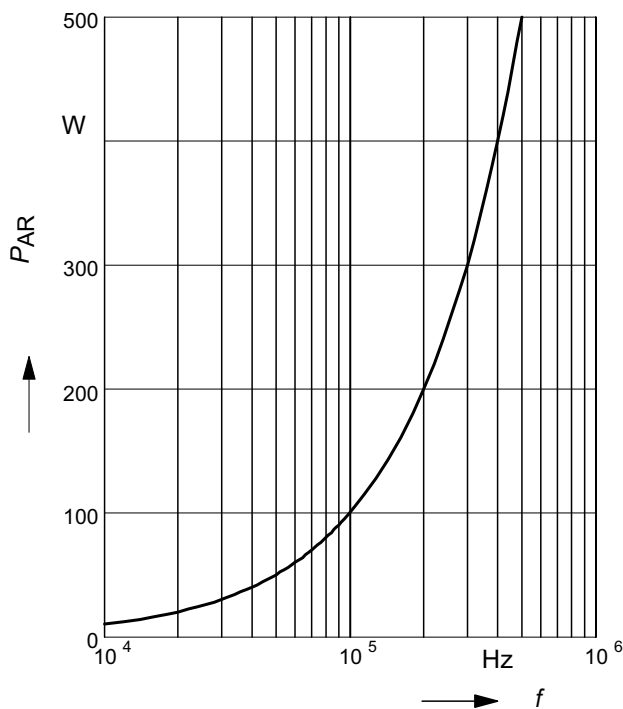

24 Typ. capacitances

$$C = f(V_{DS})$$

parameter: $V_{GS} = 0\text{ V}$, $f = 1\text{ MHz}$

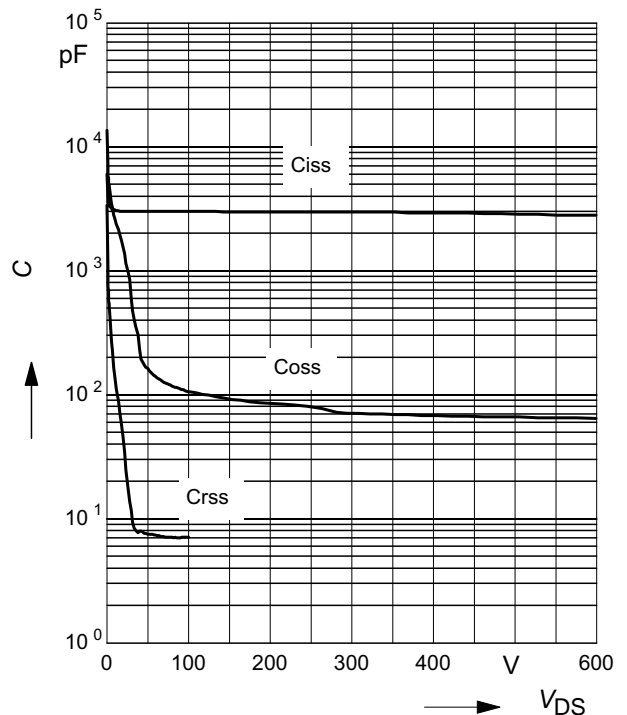

25 Typ. C_{OSS} stored energy

$$E_{OSS} = f(V_{DS})$$

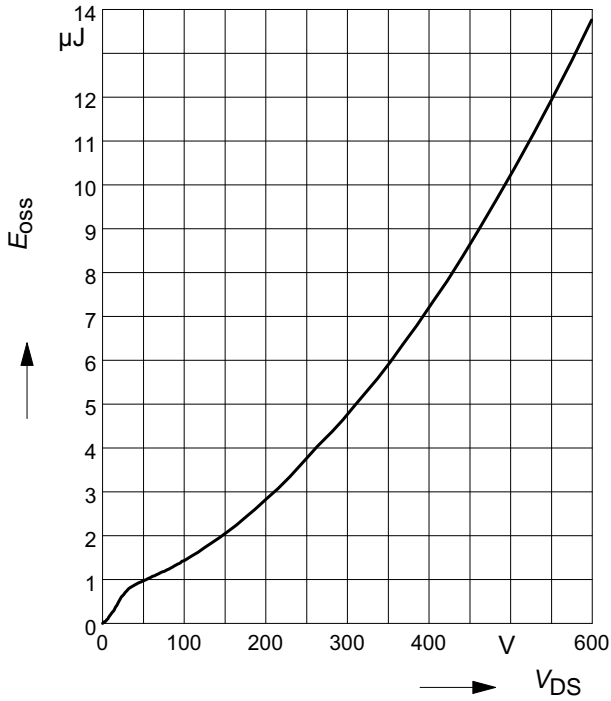

Definition of diodes switching characteristics

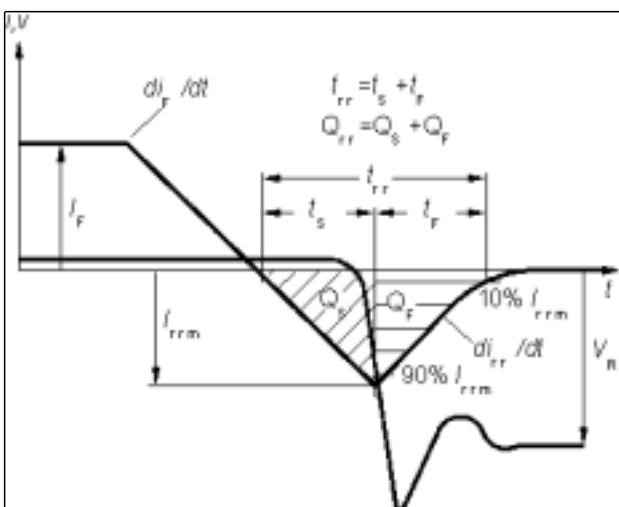

PG-TO220-3-1, PG-TO220-3-21 : Outline

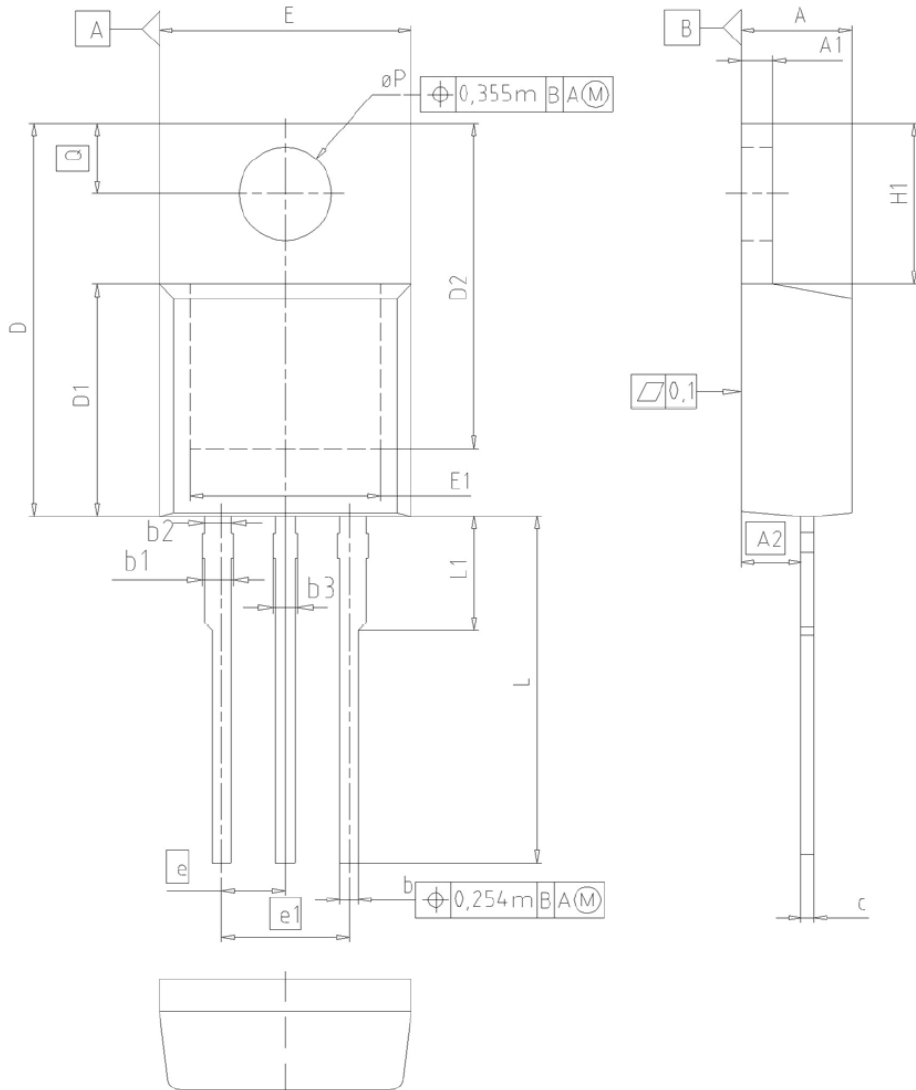

| DIM | MILLIMETERS | | INCHES | |
|-----|-------------|-------|--------|-------|
| | MIN | MAX | MIN | MAX |
| A | 4.30 | 4.57 | 0.169 | 0.180 |
| A1 | 1.17 | 1.40 | 0.046 | 0.055 |
| A2 | 2.15 | 2.72 | 0.085 | 0.107 |
| b | 0.65 | 0.86 | 0.026 | 0.034 |
| b1 | 0.95 | 1.40 | 0.037 | 0.055 |
| b2 | 0.95 | 1.15 | 0.037 | 0.045 |
| b3 | 0.65 | 1.15 | 0.026 | 0.045 |
| c | 0.33 | 0.60 | 0.013 | 0.024 |
| D | 14.81 | 15.95 | 0.583 | 0.628 |
| D1 | 8.51 | 9.45 | 0.335 | 0.372 |
| D2 | 12.19 | 13.10 | 0.480 | 0.516 |
| E | 9.70 | 10.36 | 0.382 | 0.408 |
| E1 | 6.50 | 8.60 | 0.256 | 0.339 |
| e | 2.54 | | 0.100 | |
| e1 | 5.08 | | 0.200 | |
| N | 3 | | 3 | |
| H1 | 5.90 | 6.90 | 0.232 | 0.272 |
| L | 13.00 | 14.00 | 0.512 | 0.551 |
| L1 | - | 4.80 | - | 0.189 |
| øP | 3.60 | 3.89 | 0.142 | 0.153 |
| Q | 2.60 | 3.00 | 0.102 | 0.118 |

DOCUMENT NO.
Z8B00003318

SCALE

EUROPEAN PROJECTION

ISSUE DATE
23-08-2007

REVISION
05

Outline PG-TO220 FullPAK

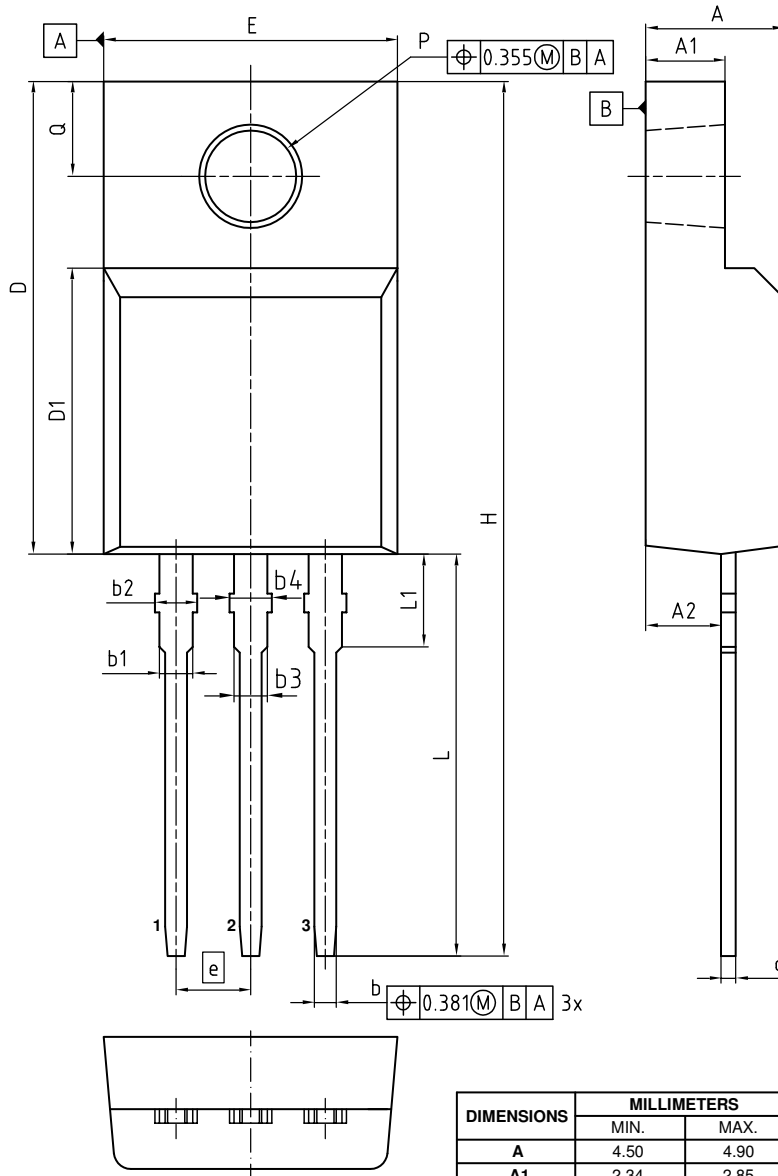

NOTES:
 ALL DIMENSIONS REFER TO JEDEC STANDARD TO-281
 AND DOES NOT INCLUDE MOLD FLASH, PROTRUSIONS
 OR GATE BURRS
 GATE BURRS ARE LESS THAN 0.5 mm

| DIMENSIONS | MILLIMETERS | |
|------------|-------------|-------|
| | MIN. | MAX. |
| A | 4.50 | 4.90 |
| A1 | 2.34 | 2.85 |
| A2 | 2.42 | 2.86 |
| b | 0.65 | 0.90 |
| b1 | 0.95 | 1.38 |
| b2 | 0.95 | 1.51 |
| b3 | 0.65 | 1.38 |
| b4 | 0.65 | 1.51 |
| c | 0.40 | 0.63 |
| D | 15.67 | 16.15 |
| D1 | 8.97 | 9.83 |
| E | 10.00 | 10.65 |
| e | 2.54 | |
| H | 28.70 | 29.75 |
| L | 12.78 | 13.75 |
| L1 | 2.83 | 3.45 |
| øP | 3.00 | 3.30 |
| Q | 3.15 | 3.50 |

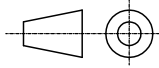
| |
|---|
| DOCUMENT NO. Z8B00003319 |
| REVISION 07 |
| SCALE 5:1 0 1 2 3 4 5mm |
| EUROPEAN PROJECTION  |
| ISSUE DATE 27.01.2017 |

PG-TO262-3-1/PG-TO262-3-21 (I²-PAK)

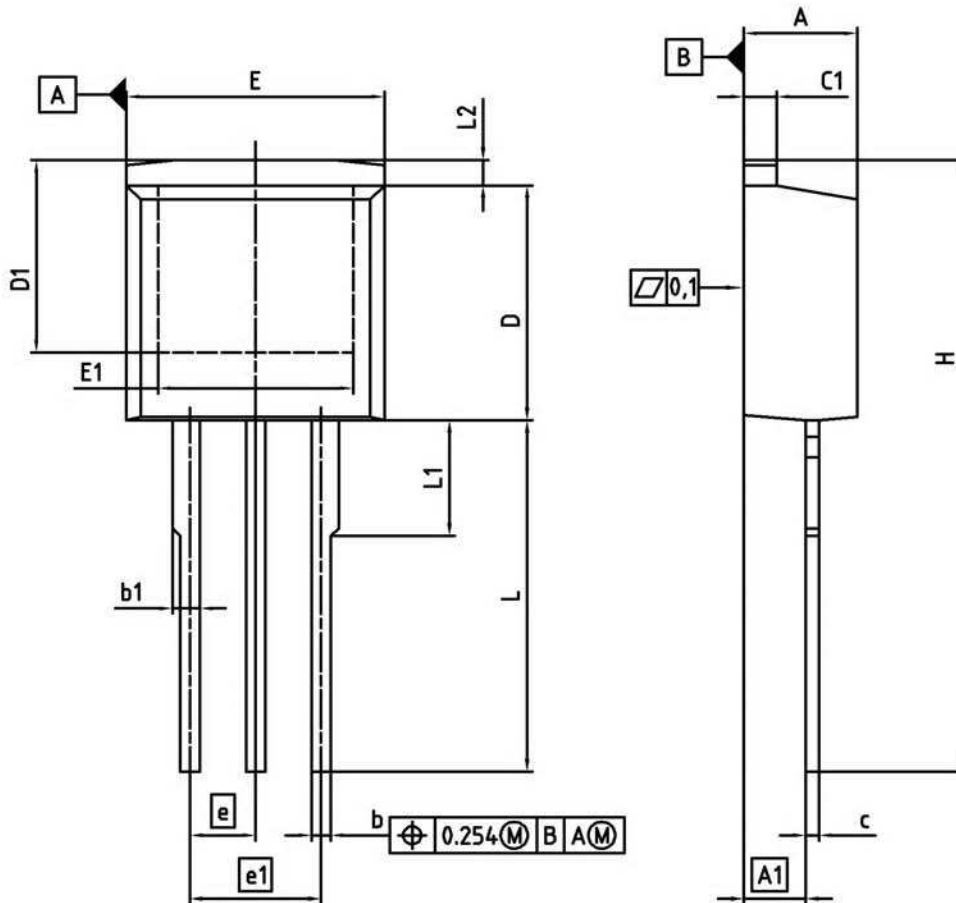

| DIM | MILLIMETERS | | INCHES | |
|-----|-------------|--------|--------|-------|
| | MIN | MAX | MIN | MAX |
| A | 4.300 | 4.572 | 0.169 | 0.180 |
| A1 | 2.150 | 2.718 | 0.085 | 0.107 |
| b | 0.650 | 0.864 | 0.026 | 0.034 |
| b1 | 0.635 | 1.400 | 0.025 | 0.055 |
| c | 0.330 | 0.600 | 0.013 | 0.024 |
| c1 | 1.170 | 1.400 | 0.046 | 0.055 |
| D | 8.509 | 9.450 | 0.335 | 0.372 |
| D1 | 6.900 | - | 0.272 | - |
| E | 9.700 | 10.363 | 0.382 | 0.408 |
| E1 | 6.500 | 8.600 | 0.256 | 0.339 |
| e | 2.540 | | 0.100 | |
| e1 | 5.080 | | 0.200 | |
| N | 3 | | 3 | |
| L | 13.000 | 14.000 | 0.512 | 0.551 |
| L1 | - | 4.800 | - | 0.189 |
| L2 | - | 1.727 | - | 0.068 |

REFERENCE
JEDEC TO262

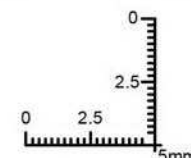

EUROPEAN PROJECTION

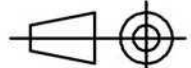

ISSUE DATE
05-05-2006

FILE
TO262_1

600V CoolMOS™ C3 Power Transistor

SPx20N60C3

Revision History

SPx20N60C3

Revision: 2018-02-27, Rev. 2.2

Previous Revision

| Revision | Date | Subjects (major changes since last revision) |
|----------|------------|--|
| 3.2 | 2018-02-27 | Outline PG-TO-220 FullPAK update |

Trademarks of Infineon Technologies AG

AURIX™, C166™, CanPAK™, CIPOS™, CoolGaN™, CoolMOS™, CoolSET™, CoolSiC™, CORECONTROL™, CROSSAVE™, DAVE™, DI-POL™, DrBlade™, EasyPIM™, EconoBRIDGE™, EconoDUAL™, EconoPACK™, EconoPIM™, EiceDRIVER™, eupec™, FCOS™, HITFET™, HybridPACK™, Infineon™, ISOFACE™, IsoPACK™, i-Wafer™, MIPAQ™, ModSTACK™, my-d™, NovalithIC™, OmniTune™, OPTIGA™, OptiMOS™, ORIGA™, POWERCODE™, PRIMARION™, PrimePACK™, PrimeSTACK™, PROFET™, PRO-SIL™, RASIC™, REAL3™, ReverSave™, SatRIC™, SIEGET™, SiPMOS™, SmartLEWIS™, SOLID FLASH™, SPOC™, TEMPFET™, thinQ!™, TRENCHSTOP™, TriCore™.

Trademarks updated August 2015

Other Trademarks

All referenced product or service names and trademarks are the property of their respective owners.

We Listen to Your Comments

Any information within this document that you feel is wrong, unclear or missing at all? Your feedback will help us to continuously improve the quality of this document. Please send your proposal (including a reference to this document) to:

erratum@infineon.com

Published by

Infineon Technologies AG

81726 München, Germany

© 2018 Infineon Technologies AG

All Rights Reserved.

Legal Disclaimer

The information given in this document shall in no event be regarded as a guarantee of conditions or characteristics ("Beschaffensgarantie").

With respect to any examples, hints or any typical values stated herein and/or any information regarding the application of the product, Infineon Technologies hereby disclaims any and all warranties and liabilities of any kind, including without limitation warranties of non-infringement of intellectual property rights of any third party.

In addition, any information given in this document is subject to customer's compliance with its obligations stated in this document and any applicable legal requirements, norms and standards concerning customer's products and any use of the product of Infineon Technologies in customer's applications.

The data contained in this document is exclusively intended for technically trained staff. It is the responsibility of customer's technical departments to evaluate the suitability of the product for the intended application and the completeness of the product information given in this document with respect to such application.

Information

For further information on technology, delivery terms and conditions and prices please contact your nearest Infineon Technologies Office (www.infineon.com).

Warnings

Due to technical requirements, components may contain dangerous substances. For information on the types in question, please contact the nearest Infineon Technologies Office.

The Infineon Technologies component described in this Data Sheet may be used in life-support devices or systems and/or automotive, aviation and aerospace applications or systems only with the express written approval of Infineon Technologies, if a failure of such components can reasonably be expected to cause the failure of that life-support, automotive, aviation and aerospace device or system or to affect the safety or effectiveness of that device or system. Life support devices or systems are intended to be implanted in the human body or to support and/or maintain and sustain and/or protect human life. If they fail, it is reasonable to assume that the health of the user or other persons may be endangered.

Mouser Electronics

Authorized Distributor

Click to View Pricing, Inventory, Delivery & Lifecycle Information:

[Infineon:](#)

[SPP20N60C3XKSA1](#) [SPI20N60C3XKSA1](#)