

LOC	DIST	REVISIONS					
BD	35	P	LTR	DESCRIPTION	DATE	DWN	APVD
		H1		REVISED PER ECO-11-004917	11MAR11	RK	HMR

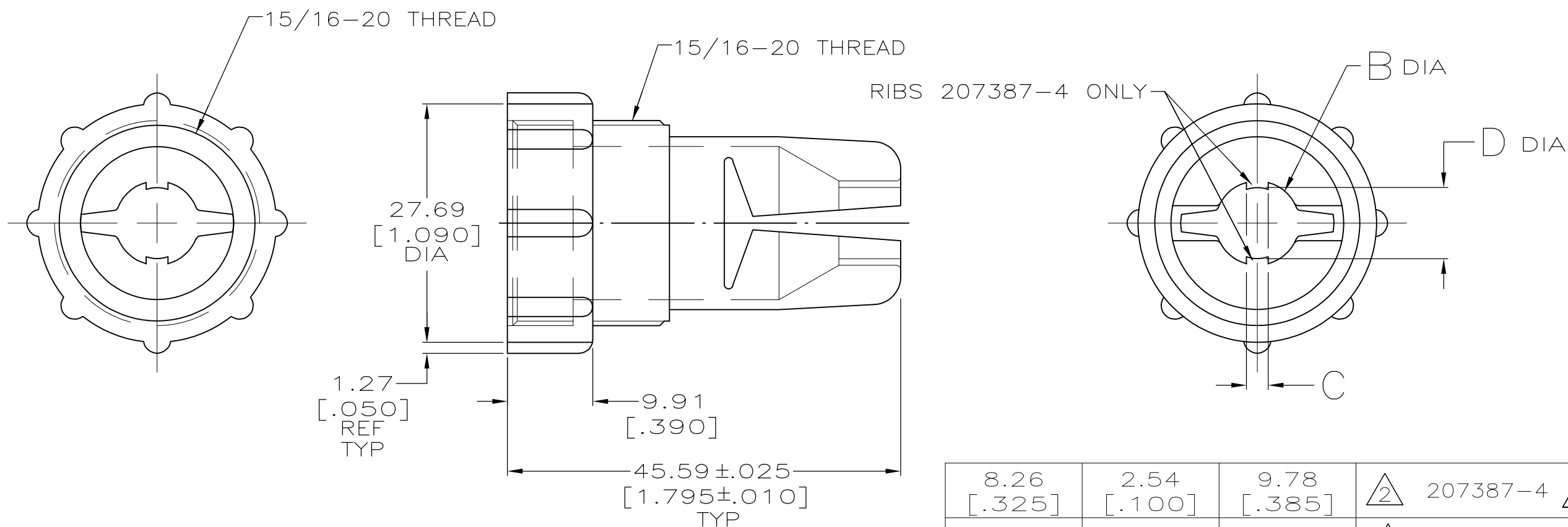

- ① CABLE RANGE OF 207387-1 WHEN USED WITH FLEXIBLE BOOT (P/N 207241-1) = 5.08-6.35 [.200-.250] DIA.
- ② CABLE RANGE OF 207387-2, & 207387-4 WHEN USED WITH FLEXIBLE BOOT (P/N 207241-1) = 6.35-8.89 [.250-.350] DIA.
- ③ OBSOLETE PART NUMBER.

8.26 [.325]	2.54 [.100]	9.78 [.385]	② 207387-4 ③
-	-	9.78 [.385]	② 207387-2
-	-	8.26 [.325]	① 207387-1
D	C	B	PART NUMBER

THIS DRAWING IS A CONTROLLED DOCUMENT.		DWN K.FOLTZ 06/20/94	TE Connectivity	
DIMENSIONS: MM[INCHES]		CHK R.STONE 06/24/94		
TOLERANCES UNLESS OTHERWISE SPECIFIED:		APVD A.FRANTUM 08/09/94	NAME CABLE GRIP, INTERNAL, SIZE 17, CPC	
0 PLC ± - 1 PLC ± - 2 PLC ± 0.13 [.005] 3 PLC ± - 4 PLC ± - ANGLES ± -		PRODUCT SPEC -	RESTRICTED TO -	
MATERIAL THERMOPLASTIC COLOR: BLACK		FINISH -	APPLICATION SPEC -	WEIGHT -
THIS DRAWING IS A CONTROLLED DOCUMENT FOR AMP INCORPORATED. IT IS SUBJECT TO CHANGE AND THE CONTROLLING ENGINEERING ORGANIZATION SHOULD BE CONTACTED FOR THE LATEST REVISION.		SIZE A3		CAGE CODE 00779
		DRAWING NO C-207387		RESTRICTED TO -
		CUSTOMER DRAWING		SCALE 2:1
		SHEET 1 OF 1		REV H1

Mouser Electronics

Authorized Distributor

Click to View Pricing, Inventory, Delivery & Lifecycle Information:

[TE Connectivity:](#)

[207387-2](#)