

PolarHT™ Module

N-Channel Enhancement Mode

$V_{DSS} = 100\text{ V}$
 $I_{D25} = 1220\text{ A}$
 $R_{DS(on)} = 1.25\text{ m}\Omega\text{ max.}$

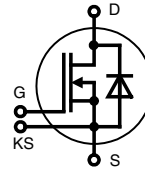

MOSFET					
Symbol	Conditions	Maximum Ratings			
V_{DSS}	$T_{VJ} = 25^{\circ}\text{C to } 150^{\circ}\text{C}$	100	V		
V_{GS}		± 20	V		
I_{D25}	$T_C = 25^{\circ}\text{C}$	1220	A		
I_{D80}	$T_C = 80^{\circ}\text{C}$	970	A		
I_{F25}	$T_C = 25^{\circ}\text{C}$ (diode)	1220	A		
I_{F80}	$T_C = 80^{\circ}\text{C}$ (diode)	970	A		
Symbol	Conditions	Characteristic Values ($T_{VJ} = 25^{\circ}\text{C}$, unless otherwise specified)			
		min.	typ.	max.	
$R_{DS(on)}$	$V_{GS} = 10\text{ V}; I_D = I_{D80}$		1.00	1.25	m Ω
			1.62	2.00	m Ω
$V_{GS(th)}$	$V_{DS} = 20\text{ V}; I_D = 3\text{ mA}$	3		5	V
I_{DSS}	$V_{DS} = 0.8 \cdot V_{DSS}; V_{GS} = 0\text{ V}; T_{VJ} = 25^{\circ}\text{C}$			0.3	mA
				6	mA
I_{GSS}	$V_{GS} = \pm 20\text{ V}; V_{DS} = 0\text{ V}$			1.2	μA
Q_g	$V_{GS} = 10\text{ V}; V_{DS} = 50\text{ V}; I_D = 1000\text{ A}$		1710		nC
Q_{gs}			396		nC
Q_{gd}			1020		nC
$t_{d(on)}$	inductive load $V_{GS} = 10\text{ V}; V_{DS} = 50\text{ V}$ $I_D = 1000\text{ A}; R_G = 1.8\ \Omega$ $R_G = R_{G\text{ ext}} + R_{\text{out driver}}$ $T_{VJ} = 25^{\circ}\text{C}$		360		ns
t_r			1620		ns
$t_{d(off)}$			460		ns
t_f			1020		ns
E_{on}			7.7		mJ
E_{off}			62.3		mJ
E_{rec}		0.57		mJ	
$t_{d(on)}$	inductive load $V_{GS} = 10\text{ V}; V_{DS} = 50\text{ V}$ $I_D = 1000\text{ A}; R_G = 1.8\ \Omega$ $R_G = R_{G\text{ ext}} + R_{\text{out driver}}$ $T_{VJ} = 125^{\circ}\text{C}$		400		ns
t_r			1640		ns
$t_{d(off)}$			560		ns
t_f			820		ns
E_{on}			8.5		mJ
E_{off}			58.9		mJ
E_{rec}		0.82		mJ	
R_{thJC}			0.053		K/W
R_{thJH}	with heat transfer paste (IXYS test setup)	0.065	0.088		K/W

Features

- PolarHT™ MOSFET technology
 - low $R_{DS(on)}$
 - dv/dt ruggedness
 - fast intrinsic reverse diode
- package
 - low inductive current path
 - screw connection to high current main terminals
 - use of non interchangeable connectors for auxiliary terminals possible
 - Kelvin source terminals for easy drive
 - isolated DCB ceramic base plate

Applications

- converters with high power density for
 - main and auxiliary AC drives of electric vehicles
 - DC drives
 - power supplies

Source Drain Diode						
Symbol	Conditions	Characteristic Values				
		min.	typ.	max.		
V_{SD}	$I_F = 1000 \text{ A}; V_{GS} = 0 \text{ V};$	$T_{VJ} = 25^\circ\text{C}$		1.03		V
		$T_{VJ} = 125^\circ\text{C}$		0.96		V
t_{rr} Q_{rr} I_{RM}	} $V_{DS} = 50 \text{ V}; I_F = 1000 \text{ A}$ $di_F/dt = 650 \text{ A}/\mu\text{s}$	$T_{VJ} = 25^\circ\text{C}$		300		ns
				12.7		μC
				72		A
t_{rr} Q_{rr} I_{RM}	} $V_{DS} = 50 \text{ V}; I_F = 1000 \text{ A}$ $di_F/dt = 630 \text{ A}/\mu\text{s}$	$T_{VJ} = 125^\circ\text{C}$		340		ns
				18		μC
				88		A

Module					
Symbol	Conditions	Ratings			
		min.	typ.	max.	
T_{VJ}		-40		150	$^\circ\text{C}$
T_{stg}		-40		125	$^\circ\text{C}$
V_{ISOL}	$I_{ISOL} \leq 1 \text{ mA}, 50/60 \text{ Hz}$			3600	V~
M_d	Mounting torque (M6)	2.25		2.75	Nm
	Terminal connection torque (M6)	4.5		5.5	Nm
Weight			250		g

Product Marking					
Ordering	Part Name	Marking on Product	Delivering Mode	Base Qty	Code Key
Standard	VMO1200-01F	VMO1200-01F	Box	2	501051

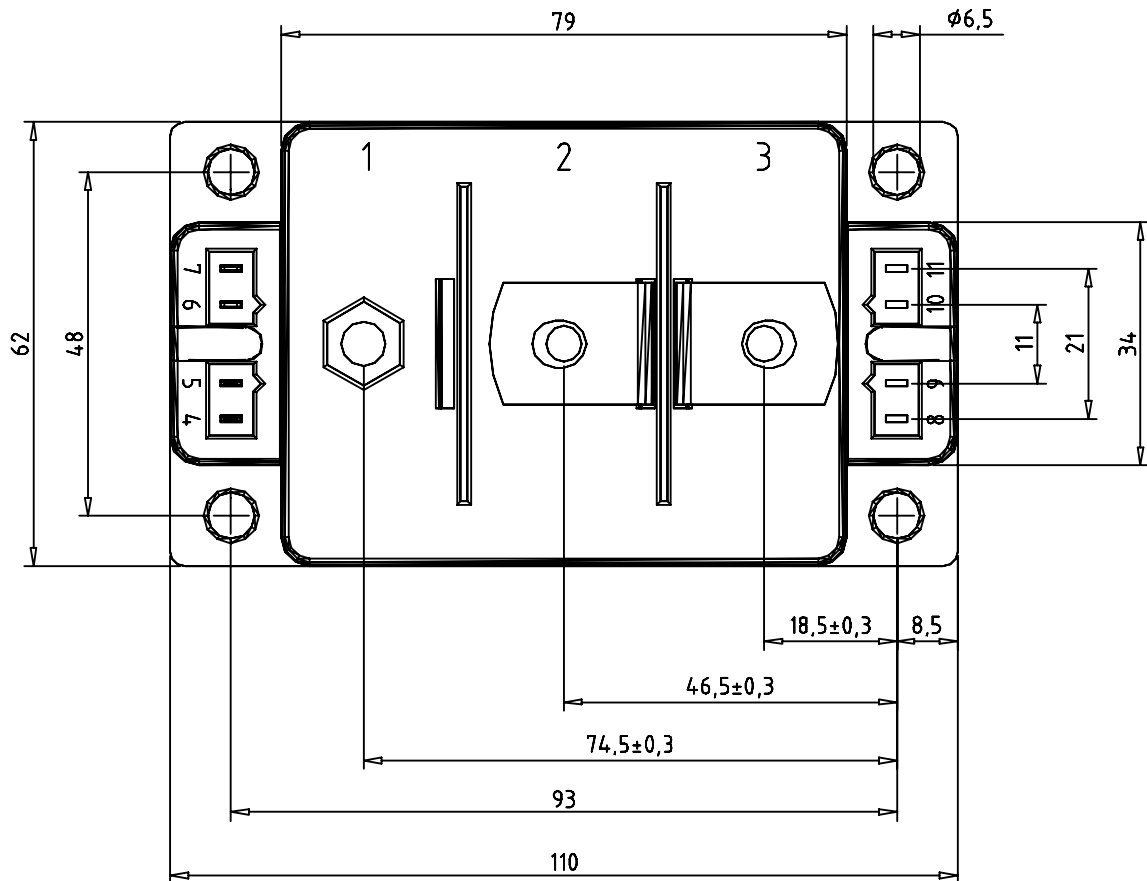
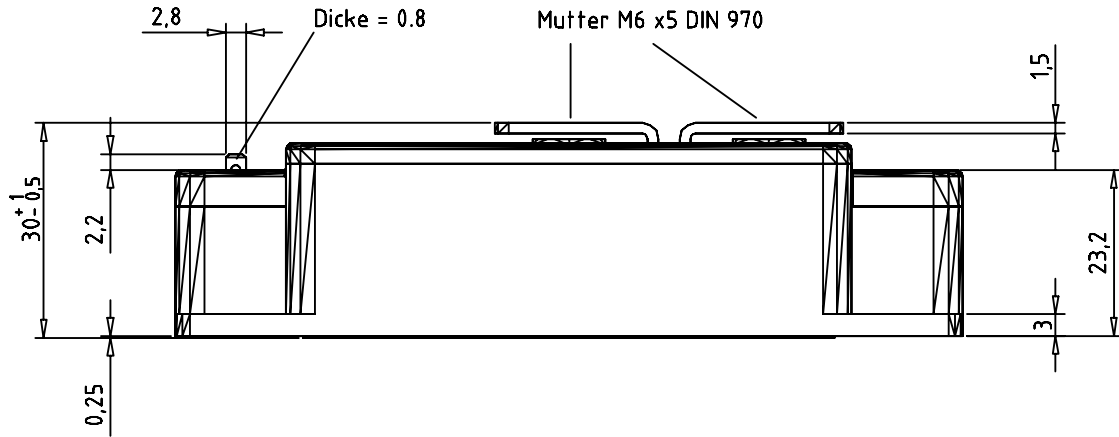
Optional accessories for modules
Dimensions in mm (1 mm = 0.0394")

keyed twin plugs
 (UL758, style 1385, CSA class 5851,
 guide 460-1-1)

- Type ZY180L with wire length 350mm
 - for pins 4 (Gate, yellow wire)
 and 5 (Kelvin Source, red wire)

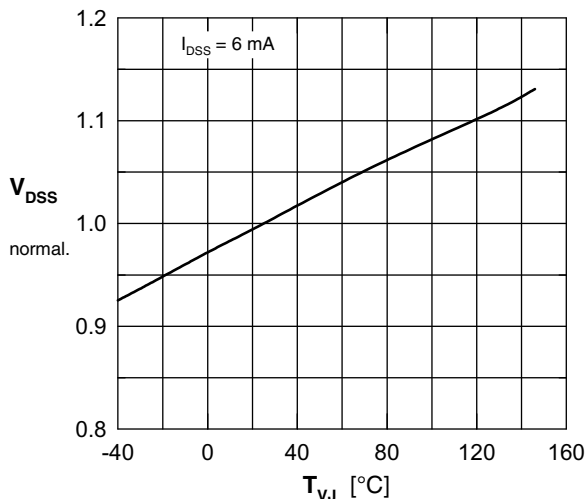

Fig. 1 Drain source breakdown voltage V_{DSS} versus junction temperature T_{VJ}

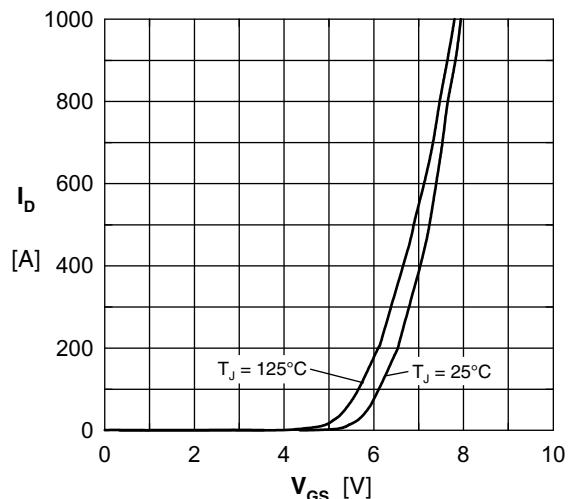

Fig. 2 Typical transfer characteristic

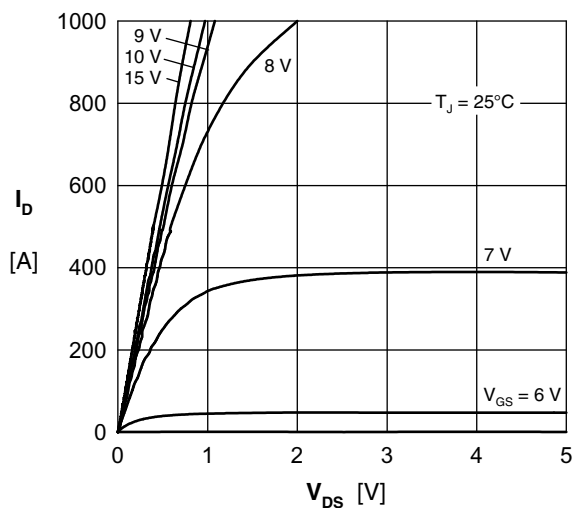

Fig. 3 Typical output characteristic

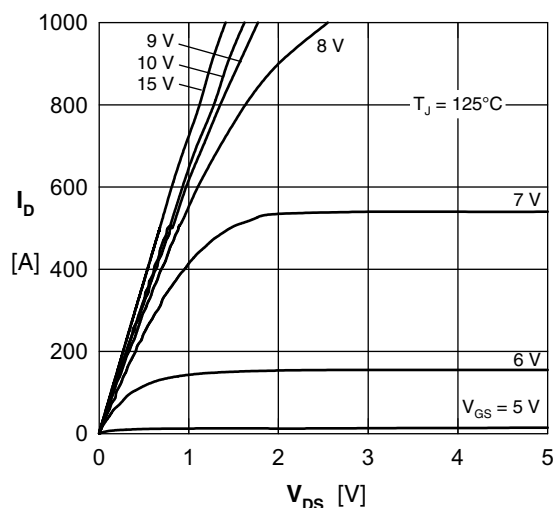

Fig. 4 Typical output characteristic

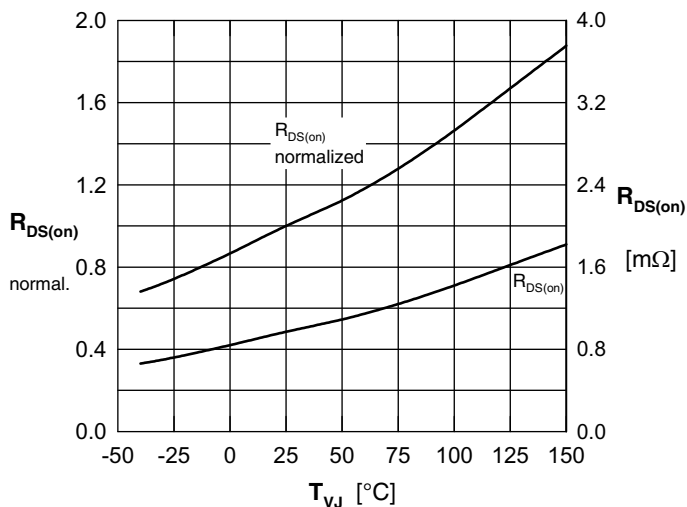

Fig. 5 Typ. drain source on-state resistance $R_{DS(on)}$ versus junction temperature T_{VJ}

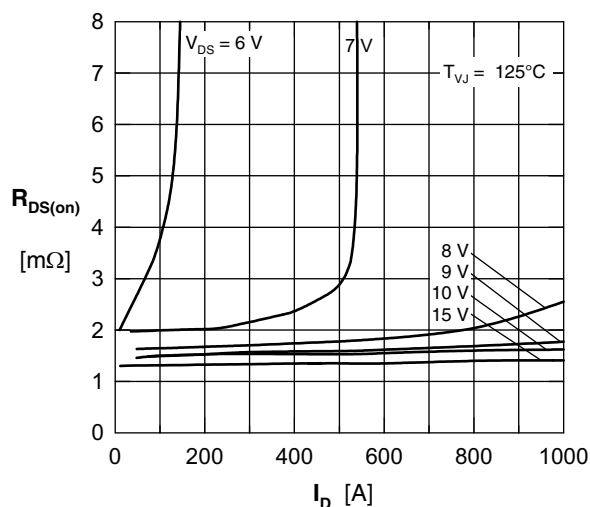

Fig. 5 Typ. drain source on-state resistance $R_{DS(on)}$ versus I_D

20100614b

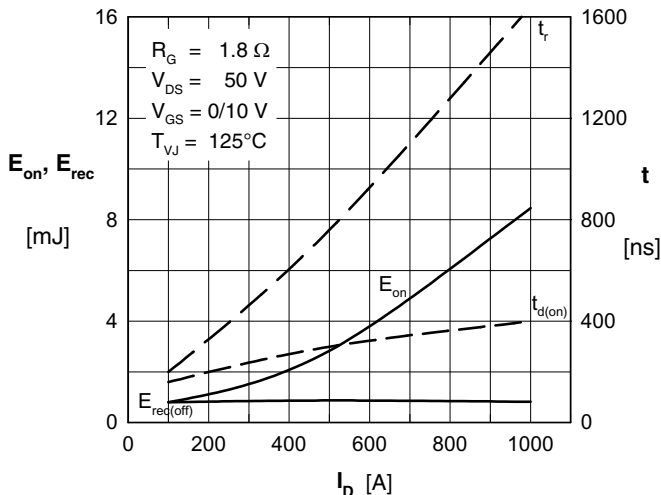

Fig. 6 Typ. turn-on energy & switching times vs. drain source current, inductive switching

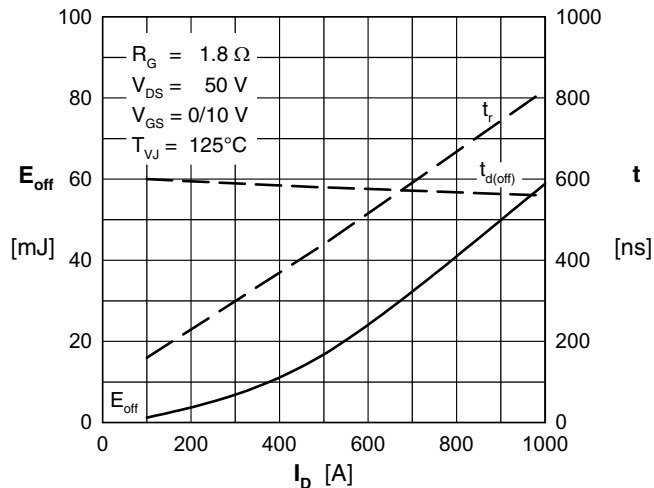

Fig. 7 Typ. turn-off energy & switching times vs. drain source current, inductive switching

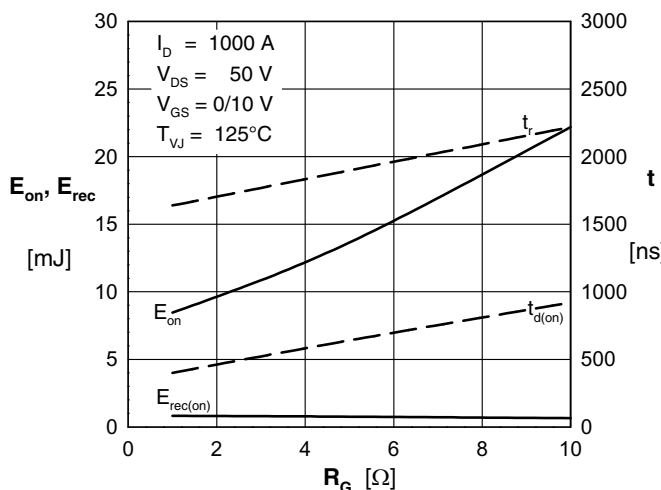

Fig. 8 Typ. turn-on energy & switching times vs. gate resistor, inductive switching

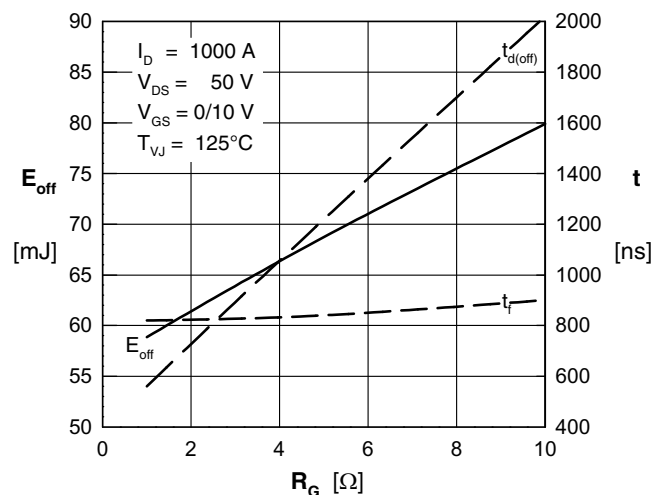

Fig. 9 Typ. turn-off energy & switching times vs. gate resistor, inductive switching

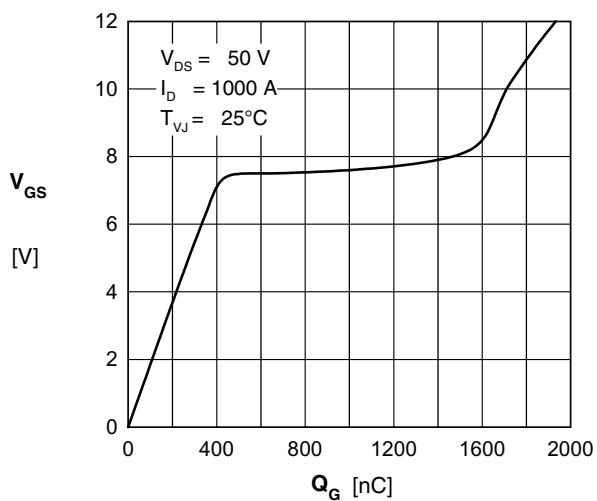

Fig. 10 Typical gate charge characteristic

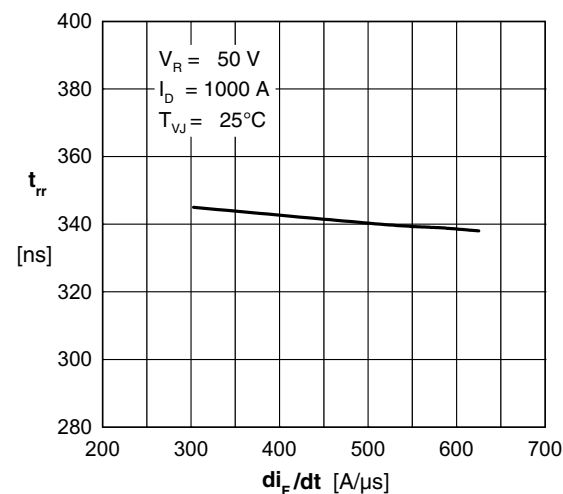

Fig. 11 Typ. reverse recovery time t_{rr} of the body diode versus di/dt

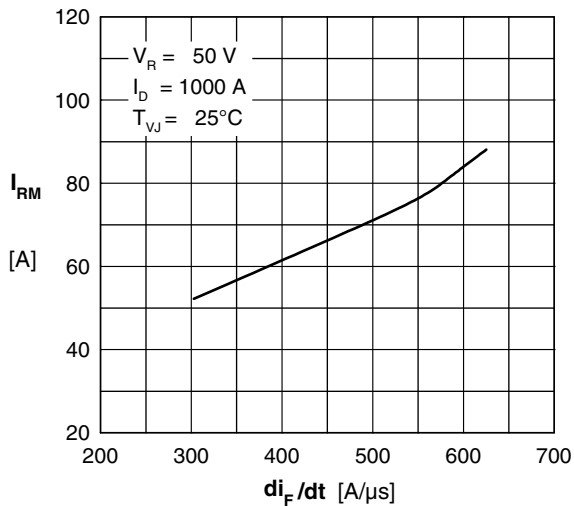

Fig. 13 Typ. reverse recovery current I_{RM} of the body diode versus di/dt

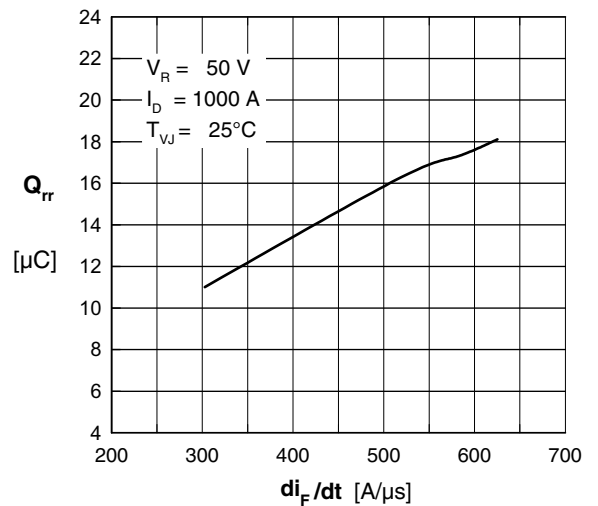

Fig. 14 Typical reverse recovery charge Q_{rr} of the body diode versus di/dt

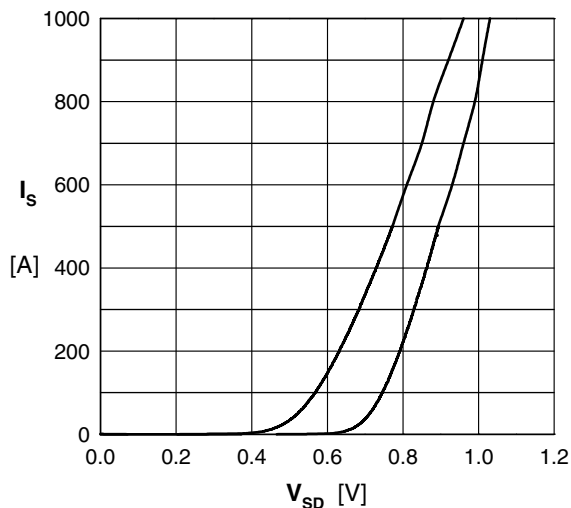

Fig. 15 Source drain current I_F (body diode) vs. typical source drain voltage V_{SD}

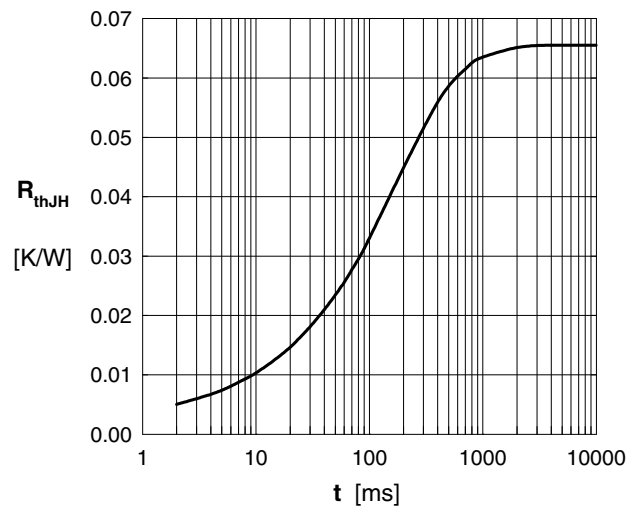

Fig. 16 Typ. transient thermal impedance with heat transfer paste (IXYS test setup)

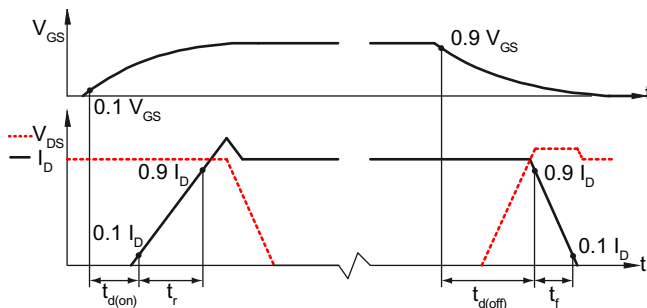

Fig. 17 Definition of switching times

Mouser Electronics

Authorized Distributor

Click to View Pricing, Inventory, Delivery & Lifecycle Information:

[IXYS:](#)

[VMO1200-01F](#)