

FEATURES

Multipoint LVDS transceivers (low voltage differential signaling driver and receiver pairs)

Switching rate: 200 Mbps (100 MHz)

Supported bus loads: 30 Ω to 55 Ω

Choice of 2 receiver types

Type 1 (ADN4691E/ADN4693E): hysteresis of 25 mV

Type 2 (ADN4696E/ADN4697E): threshold offset of 100 mV for open-circuit and bus-idle fail-safe

Conforms to TIA/EIA-899 standard for M-LVDS

Glitch free power-up/power-down on M-LVDS bus

Controlled transition times on driver output

Common-mode range: -1 V to $+3.4$ V, allowing communication with 2 V of ground noise

Driver outputs high-Z when disabled or powered off

Enhanced ESD protection on bus pins

± 15 kV HBM (human body model), air discharge

± 8 kV HBM (human body model), contact discharge

± 10 kV IEC 61000-4-2, air discharge

± 8 kV IEC 61000-4-2, contact discharge

Operating temperature range: -40°C to $+85^{\circ}\text{C}$

Available in 8-lead (ADN4691E/ADN4696E) and 14-lead (ADN4693E/ADN4697E) SOIC packages

APPLICATIONS

Backplane and cable multipoint data transmission

Multipoint clock distribution

Low power, high speed alternative to shorter RS-485 links

Networking and wireless base station infrastructure

GENERAL DESCRIPTION

The ADN4691E/ADN4693E/ADN4696E/ADN4697E are multipoint, low voltage differential signaling (M-LVDS) transceivers (driver and receiver pairs) that can operate at up to 200 Mbps (100 MHz). The receivers detect the bus state with a differential input of as little as 50 mV over a common-mode voltage range of -1 V to $+3.4$ V. ESD protection of up to ± 15 kV is implemented on the bus pins. The devices adhere to the TIA/EIA-899 standard for M-LVDS and complement TIA/EIA-644 LVDS devices with additional multipoint capabilities.

The ADN4691E/ADN4693E are Type 1 receivers with 25 mV of hysteresis so that slow-changing signals or loss of input does not lead to output oscillations. The ADN4696E/ADN4697E are Type 2 receivers exhibiting an offset threshold, guaranteeing the output state when the bus is idle (bus-idle fail-safe) or the inputs are open (open-circuit fail-safe).

FUNCTIONAL BLOCK DIAGRAMS

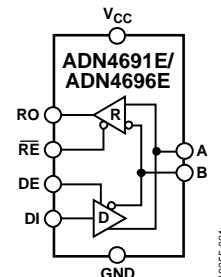

Figure 1.

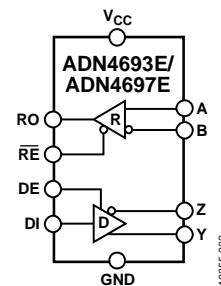

Figure 2.

The devices are available as half-duplex in an 8-lead SOIC package (the ADN4691E/ADN4696E) or as full-duplex in a 14-lead SOIC package (the ADN4693E/ADN4697E). A selection table for the ADN4690E to ADN4697E devices is shown in Table 1.

Table 1. ADN4690E to ADN4697E Selection Table

Part No.	Receiver	Data Rate	SOIC	Duplex
ADN4690E	Type 1	100 Mbps	8-lead	Half
ADN4691E	Type 1	200 Mbps	8-lead	Half
ADN4692E	Type 1	100 Mbps	14-lead	Full
ADN4693E	Type 1	200 Mbps	14-lead	Full
ADN4694E	Type 2	100 Mbps	8-lead	Half
ADN4695E	Type 2	100 Mbps	14-lead	Full
ADN4696E	Type 2	200 Mbps	8-lead	Half
ADN4697E	Type 2	200 Mbps	14-lead	Full

TABLE OF CONTENTS

Features	1	Driver Voltage and Current Measurements.....	11
Applications.....	1	Driver Timing Measurements	12
Functional Block Diagrams.....	1	Receiver Timing Measurements.....	13
General Description	1	Theory of Operation	14
Revision History	2	Half-Duplex/Full-Duplex Operation.....	14
Specifications.....	3	Three-State Bus Connection.....	14
Receiver Input Threshold Test Voltages	4	Truth Tables.....	14
Timing Specifications	5	Glitch-Free Power-Up/Power-Down	15
Absolute Maximum Ratings.....	6	Fault Conditions	15
Thermal Resistance	6	Receiver Input Thresholds/Fail-Safe.....	15
ESD Caution.....	6	Applications Information	16
Pin Configurations and Function Descriptions	7	Outline Dimensions	17
Typical Performance Characteristics	8	Ordering Guide	17
Test Circuits and Switching Characteristics.....	11		

REVISION HISTORY

1/16—Rev. A to Rev. B

Change to Table 6	6
-------------------------	---

3/12—Rev. 0 to Rev. A

Added ADN4691E and ADN4693E.....	Universal
Changes to Features Section, General Description Section, and Table 1	1
Added Type 1 Receiver Parameters, Table 2	3
Added Table 3, Renumbered Sequentially	4
Added Type 1 Receiver Parameters, Table 5	5

Added Table 7	6
Changes to Table 8.....	7
Changes to Figure 33.....	13
Added Table 12	14
Changes to Receiver Input Thresholds/Fail-Safe Section and Figure 36.....	15
Changes to Ordering Guide	17

12/11—Revision 0: Initial Version

SPECIFICATIONS

$V_{CC} = 3.0\text{ V to }3.6\text{ V}$; $R_L = 50\ \Omega$; $T_A = T_{MIN}$ to T_{MAX} , unless otherwise noted.¹

Table 2.

Parameter	Symbol	Min	Typ	Max	Unit	Test Conditions/Comments
DRIVER						
Differential Outputs						
Differential Output Voltage Magnitude	$ V_{OD} $	480		650	mV	See Figure 19
$\Delta V_{OD} $ for Complementary Output States	$\Delta V_{OD} $	-50		+50	mV	See Figure 19
Common-Mode Output Voltage (Steady State)	$V_{OC(SS)}$	0.8		1.2	V	See Figure 20, Figure 23
$\Delta V_{OC(SS)}$ for Complementary Output States	$\Delta V_{OC(SS)}$	-50		+50	mV	See Figure 20, Figure 23
Peak-to-Peak V_{OC}	$V_{OC(PP)}$			150	mV	See Figure 20, Figure 23
Maximum Steady-State Open-Circuit Output Voltage	$V_{A(O)}, V_{B(O)}, V_{Y(O)},$ or $V_{Z(O)}$	0		2.4	V	See Figure 21
Voltage Overshoot						
Low to High	V_{PH}			$1.2 V_{SS}$	V	See Figure 24, Figure 27
High to Low	V_{PL}	$-0.2 V_{SS}$			V	See Figure 24, Figure 27
Output Current						
Short Circuit	$ I_{OS} $			24	mA	See Figure 22
High Impedance State, Driver Only	I_{OZ}	-15		+10	μA	$-1.4\text{ V} \leq (V_Y \text{ or } V_Z) \leq 3.8\text{ V}$, other output = 1.2 V
Power Off	$I_{O(OFF)}$	-10		+10	μA	$-1.4\text{ V} \leq (V_Y \text{ or } V_Z) \leq 3.8\text{ V}$, other output = 1.2 V, $0\text{ V} \leq V_{CC} \leq 1.5\text{ V}$
Output Capacitance						
Differential Output Capacitance	C_{YZ}		3	2.5	pF	$V_I = 0.4 \sin(30e^{6\pi t})\text{ V} + 0.5\text{ V}$, ² other output = 1.2 V, DE = 0 V
Output Capacitance Balance (C_Y/C_Z)	$C_{Y/Z}$	0.99		1.01		$V_{AB} = 0.4 \sin(30e^{6\pi t})\text{ V}$, ² DE = 0 V
Logic Inputs (DI, DE)						
Input High Voltage	V_{IH}	2		V_{CC}	V	
Input Low Voltage	V_{IL}	GND		0.8	V	
Input High Current	I_{IH}	0		10	μA	$V_{IH} = 2\text{ V}$
Input Low Current	I_{IL}	0		10	μA	$V_{IL} = 0.8\text{ V}$
RECEIVER						
Differential Inputs						
Differential Input Threshold Voltage						
Type 1 Receiver (ADN4691E, ADN4693E)	V_{TH}	-50		+50	mV	See Table 3, Figure 36
Type 2 Receiver (ADN4696E, ADN4697E)	V_{TH}	50		150	mV	See Table 4, Figure 36
Input Hysteresis						
Type 1 Receiver (ADN4691E, ADN4693E)	V_{HYS}		25		mV	
Type 2 Receiver (ADN4696E, ADN4697E)	V_{HYS}		0		mV	
Differential Input Voltage Magnitude	$ V_{ID} $	0.05		V_{CC}	V	
Input Capacitance						
Differential Input Capacitance	C_{AB}			2.5	pF	$V_I = 0.4 \sin(30e^{6\pi t})\text{ V} + 0.5\text{ V}$, ² other input = 1.2 V
Input Capacitance Balance (C_A/C_B)	$C_{A/B}$	0.99		1.01		$V_{AB} = 0.4 \sin(30e^{6\pi t})\text{ V}$ ²
Logic Output RO						
Output High Voltage	V_{OH}	2.4			V	$I_{OH} = -8\text{ mA}$
Output Low Voltage	V_{OL}			0.4	V	$I_{OL} = 8\text{ mA}$
High Impedance Output Current	I_{OZ}	-10		+15	μA	$V_O = 0\text{ V or }3.6\text{ V}$
Logic Input \overline{RE}						
Input High Voltage	V_{IH}	2		V_{CC}	V	
Input Low Voltage	V_{IL}	GND		0.8	V	
Input High Current	I_{IH}	-10		0	μA	$V_{IH} = 2\text{ V}$
Input Low Current	I_{IL}	-10		0	μA	$V_{IL} = 0.8\text{ V}$

Parameter	Symbol	Min	Typ	Max	Unit	Test Conditions/Comments
BUS INPUT/OUTPUT						
Input Current						
A (Receiver or Transceiver with Driver Disabled)	I_A	0		32	μA	$V_B = 1.2\text{ V}, V_A = 3.8\text{ V}$
		-20		+20	μA	$V_B = 1.2\text{ V}, V_A = 0\text{ V or } 2.4\text{ V}$
		-32		0	μA	$V_B = 1.2\text{ V}, V_A = -1.4\text{ V}$
B (Receiver or Transceiver with Driver Disabled)	I_B	0		32	μA	$V_A = 1.2\text{ V}, V_B = 3.8\text{ V}$
		-20		+20	μA	$V_A = 1.2\text{ V}, V_B = 0\text{ V or } 2.4\text{ V}$
		-32		0	μA	$V_A = 1.2\text{ V}, V_B = -1.4\text{ V}$
Differential (Receiver or Transceiver with Driver Disabled)	I_{AB}	-4		+4	μA	$V_A = V_B, 1.4\text{ V} \leq V_A \leq 3.8\text{ V}$
Power-Off Input Current						
A (Receiver or Transceiver)						
	$I_{A(\text{OFF})}$	0		32	μA	$0\text{ V} \leq V_{CC} \leq 1.5\text{ V}$ $V_B = 1.2\text{ V}, V_A = 3.8\text{ V}$
		-20		+20	μA	$V_B = 1.2\text{ V}, V_A = 0\text{ V or } 2.4\text{ V}$
		-32		0	μA	$V_B = 1.2\text{ V}, V_A = -1.4\text{ V}$
B (Receiver or Transceiver)	$I_{B(\text{OFF})}$	0		32	μA	$V_A = 1.2\text{ V}, V_B = 3.8\text{ V}$
		-20		+20	μA	$V_A = 1.2\text{ V}, V_B = 0\text{ V or } 2.4\text{ V}$
		-32		0	μA	$V_A = 1.2\text{ V}, V_B = -1.4\text{ V}$
Differential (Receiver or Transceiver)	$I_{AB(\text{OFF})}$	-4		+4	μA	$V_A = V_B, 1.4 \leq V_A \leq 3.8\text{ V}$
Input Capacitance (Transceiver with Driver Disabled)	$C_A \text{ or } C_B$		5		pF	$V_I = 0.4 \sin(30e^6\pi t)\text{ V} + 0.5\text{ V},^2$ other input = 1.2 V, DE = 0 V
Differential Input Capacitance (Transceiver with Driver Disabled)	C_{AB}			3	pF	$V_{AB} = 0.4 \sin(30e^6\pi t)\text{ V},^2$ DE = 0 V
Input Capacitance Balance (C_A/C_B) (Transceiver with Driver Disabled)	$C_{A/B}$	0.99		1.01		DE = 0 V
POWER SUPPLY						
Supply Current						
Only Driver Enabled	I_{CC}		13	22	mA	DE, $\overline{RE} = V_{CC}, R_L = 50\ \Omega$
Both Driver and Receiver Disabled			1	4	mA	DE = 0 V, $\overline{RE} = V_{CC}, R_L = \text{no load}$
Both Driver and Receiver Enabled			16	24	mA	DE = $V_{CC}, \overline{RE} = 0\text{ V}, R_L = 50\ \Omega$
Only Receiver Enabled			4	13	mA	DE, $\overline{RE} = 0\text{ V}, R_L = 50\ \Omega$

¹ All typical values are given for $V_{CC} = 3.3\text{ V}$ and $T_A = 25^\circ\text{C}$.

² HP4194A impedance analyzer (or equivalent).

RECEIVER INPUT THRESHOLD TEST VOLTAGES

$\overline{RE} = 0\text{ V}$, H = high, L = low

Table 3. Test Voltages for Type 1 Receiver

Applied Voltages		Input Voltage, Differential	Input Voltage, Common Mode	Receiver Output
V_A (V)	V_B (V)	V_{ID} (V)	V_{IC} (V)	RO (V)
2.4	0	2.4	1.2	H
0	2.4	-2.4	1.2	L
3.8	3.75	0.05	3.775	H
3.75	3.8	-0.05	3.775	L
-1.35	-1.4	0.05	-1.375	H
-1.4	-1.35	-0.05	-1.375	L

Table 4. Test Voltages for Type 2 Receiver

Applied Voltages		Input Voltage, Differential	Input Voltage, Common Mode	Receiver Output
V _A (V)	V _B (V)	V _{ID} (V)	V _{IC} (V)	RO (V)
+2.4	0	+2.4	+1.2	H
0	+2.4	-2.4	+1.2	L
+3.8	+3.65	+0.15	+3.725	H
+3.8	+3.75	+0.05	+3.775	L
-1.25	-1.4	+0.15	-1.325	H
-1.35	-1.4	+0.05	-1.375	L

TIMING SPECIFICATIONS

V_{CC} = 3.0 V to 3.6 V; T_A = T_{MIN} to T_{MAX}, unless otherwise noted.¹

Table 5.

Parameter	Symbol	Min	Typ	Max	Unit	Test Conditions/Comments
DRIVER						
Maximum Data Rate		200			Mbps	
Propagation Delay	t _{PLH} , t _{PHL}	1	1.5	2.4	ns	See Figure 24, Figure 27
Differential Output Rise/Fall Time	t _R , t _F	1		1.6	ns	See Figure 24, Figure 27
Pulse Skew t _{PHL} - t _{PLH}	t _{SK}		0	100	ps	See Figure 24, Figure 27
Part-to-Part Skew ²	t _{SK(PP)}			1	ns	See Figure 24, Figure 27
Period Jitter, RMS (1 Standard Deviation) ³	t _{J(PER)}		2	3	ps	100 MHz clock input ⁴ (see Figure 26)
Peak-to-Peak Jitter ^{3,5}	t _{J(PP)}		30	130	ps	200 Mbps 2 ¹⁵ - 1 PRBS input ⁶ (see Figure 29)
Disable Time from High Level	t _{PHZ}			7	ns	See Figure 25, Figure 28
Disable Time from Low Level	t _{PLZ}			7	ns	See Figure 25, Figure 28
Enable Time to High Level	t _{PZH}			7	ns	See Figure 25, Figure 28
Enable Time to Low Level	t _{PZL}			7	ns	See Figure 25, Figure 28
RECEIVER						
Propagation Delay	t _{RPLH} , t _{RPHL}	2	4	6	ns	C _L = 15 pF (see Figure 30, Figure 33)
Rise/Fall Time	t _R , t _F	1		2.3	ns	C _L = 15 pF (see Figure 30, Figure 33)
Pulse Skew t _{RPHL} - t _{RPLH}	t _{SK}					C _L = 15 pF (see Figure 30, Figure 33)
Type 1 Receiver (ADN4691E, ADN4693E)			100	300	ps	
Type 2 Receiver (ADN4696E, ADN4697E)			300	500	ps	
Part-to-Part Skew ²	t _{SK(PP)}			1	ns	C _L = 15 pF (see Figure 30, Figure 33)
Period Jitter, RMS (1 Standard Deviation) ³	t _{J(PER)}		4	7	ps	100 MHz clock input ⁷ (see Figure 32)
Peak-to-Peak Jitter ^{3,5}	t _{J(PP)}					200 Mbps 2 ¹⁵ - 1 PRBS input ⁸ (see Figure 35)
Type 1 Receiver (ADN4691E, ADN4693E)	t _{J(PP)}		300	700	ps	
Type 2 Receiver (ADN4696E, ADN4697E)	t _{J(PP)}		450	800	ps	
Disable Time from High Level	t _{RPHZ}			10	ns	See Figure 31, Figure 34
Disable Time from Low Level	t _{RPLZ}			10	ns	See Figure 31, Figure 34
Enable Time to High Level	t _{RPZH}			15	ns	See Figure 31, Figure 34
Enable Time to Low Level	t _{RPZL}			15	ns	See Figure 31, Figure 34

¹ All typical values are given for V_{CC} = 3.3 V and T_A = 25°C.

² t_{SK(PP)} is defined as the difference between the propagation delays of two devices between any specified terminals. This specification applies to devices at the same V_{CC} and temperature, and with identical packages and test circuits.

³ Jitter parameters are guaranteed by design and characterization. Values do not include stimulus jitter.

⁴ t_R = t_F = 0.5 ns (10% to 90%), measured over 30,000 samples.

⁵ Peak-to-peak jitter specifications include jitter due to pulse skew (t_{SK}).

⁶ t_R = t_F = 0.5 ns (10% to 90%), measured over 100,000 samples.

⁷ |V_{ID}| = 400 mV (ADN4696E, ADN4697E), V_{IC} = 1.1 V, t_R = t_F = 0.5 ns (10% to 90%), measured over 30,000 samples.

⁸ |V_{ID}| = 400 mV (ADN4696E, ADN4697E), V_{IC} = 1.1 V, t_R = t_F = 0.5 ns (10% to 90%), measured over 100,000 samples.

ABSOLUTE MAXIMUM RATINGS

$T_A = T_{MIN}$ to T_{MAX} , unless otherwise noted.

Table 6.

Parameter	Rating
V_{CC}	-0.5 V to +4 V
Digital Input Voltage (DE, \overline{RE} , DI)	-0.5 V to +4 V
Receiver Input (A, B) Voltage	
Half-Duplex (ADN4691E, ADN4696E)	-1.8 V to +4 V
Full-Duplex (ADN4693E, ADN4697E)	-4 V to +6 V
Receiver Output Voltage (RO)	-0.3 V to +4 V
Driver Output (A, B, Y, Z) Voltage	-1.8 V to +4 V
ESD Rating (A, B, Y, Z Pins)	
HBM (Human Body Model)	
Air Discharge	±15 kV
Contact Discharge	±8 kV
IEC 61000-4-2, Air Discharge	±10 kV
IEC 61000-4-2, Contact Discharge	±8 kV
ESD Rating (Other Pins, HBM)	±4 kV
ESD Rating (All Pins)	
FICDM	±1.25 kV
Operating Temperature Range	-40°C to +85°C
Storage Temperature Range	-65°C to +150°C

Stresses at or above those listed under Absolute Maximum Ratings may cause permanent damage to the product. This is a stress rating only; functional operation of the product at these or any other conditions above those indicated in the operational section of this specification is not implied. Operation beyond the maximum operating conditions for extended periods may affect product reliability.

THERMAL RESISTANCE

θ_{JA} is specified for the worst case conditions, that is, a device soldered in a circuit board for surface-mount packages.

Table 7. Thermal Resistance

Package Type	θ_{JA}	Unit
8-Lead SOIC	121	°C/W
14-Lead SOIC	86	°C/W

ESD CAUTION



ESD (electrostatic discharge) sensitive device. Charged devices and circuit boards can discharge without detection. Although this product features patented or proprietary protection circuitry, damage may occur on devices subjected to high energy ESD. Therefore, proper ESD precautions should be taken to avoid performance degradation or loss of functionality.

PIN CONFIGURATIONS AND FUNCTION DESCRIPTIONS

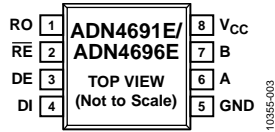

Figure 3. ADN4691E/ADN4696E Pin Configuration

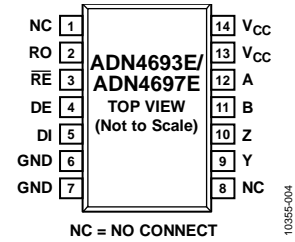

Figure 4. ADN4693E/ADN4697E Pin Configuration

Table 8. Pin Function Descriptions

ADN4691E/ ADN4696E Pin No. ¹	ADN4693E/ ADN4697E Pin No. ¹	Mnemonic	Description
1	2	RO	Receiver Output. Type 1 receiver (ADN4691E/ADN4693E), when enabled: If $A - B \geq 50$ mV, then RO = logic high. If $A - B \leq -50$ mV, then RO = logic low. Type 2 receiver (ADN4696E/ADN4697E), when enabled: If $A - B \geq 150$ mV, then RO = logic high. If $A - B \leq 50$ mV, then RO = logic low. Receiver output is undefined outside these conditions.
2	3	\overline{RE}	Receiver Output Enable. A logic low on this pin enables the receiver output, RO. A logic high on this pin places RO in a high impedance state.
3	4	DE	Driver Output Enable. A logic high on this pin enables the driver differential outputs. A logic low on this pin places the driver differential outputs in a high impedance state.
4	5	DI	Driver Input. Half-duplex (ADN4691E/ADN4696E), when enabled: A logic low on DI forces A low and B high, whereas a logic high on DI forces A high and B low. Full-duplex (ADN4693E/ADN4697E), when enabled: A logic low on DI forces Y low and Z high, whereas a logic high on DI forces Y high and Z low.
5	6, 7	GND	Ground.
N/A	9	Y	Noninverting Driver Output Y.
N/A	10	Z	Inverting Driver Output Z.
6	N/A	A	Noninverting Receiver Input A and Noninverting Driver Output A.
N/A	12	A	Noninverting Receiver Input A.
7	N/A	B	Inverting Receiver Input B and Inverting Driver Output B.
N/A	11	B	Inverting Receiver Input B.
8	13, 14	V _{CC}	Power Supply (3.3 V \pm 0.3 V).
N/A	1, 8	NC	No Connect. Do not connect to these pins.

¹ N/A means not applicable.

TYPICAL PERFORMANCE CHARACTERISTICS

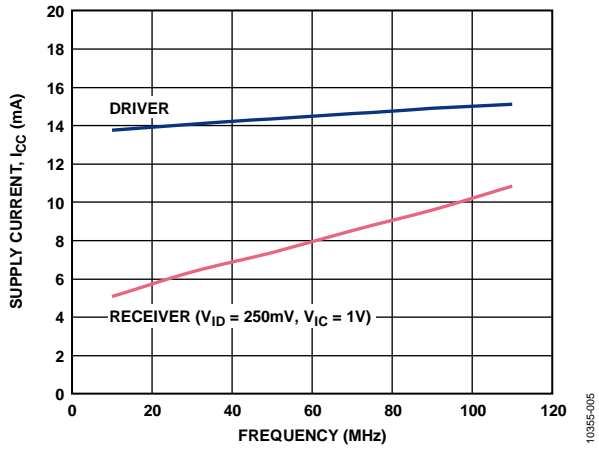

Figure 5. Power Supply Current (I_{CC}) vs. Frequency ($V_{CC} = 3.3\text{ V}$, $T_A = 25^\circ\text{C}$; Receiver $V_{ID} = 250\text{ mV}$, $V_{IC} = 1\text{ V}$)

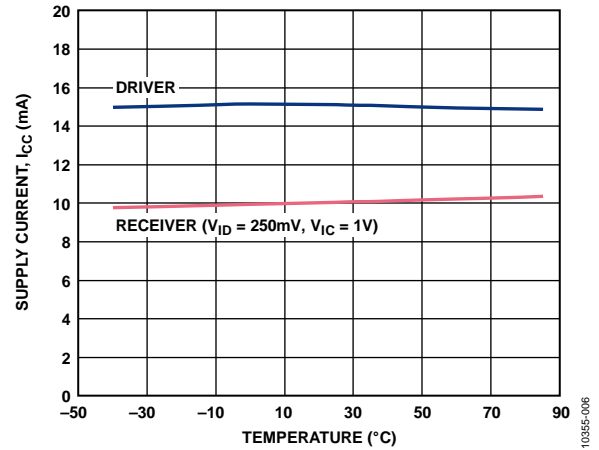

Figure 6. Power Supply Current vs. Temperature (Data Rate = 200 Mbps, $V_{CC} = 3.3\text{ V}$; Receiver $V_{ID} = 250\text{ mV}$, $V_{IC} = 1\text{ V}$)

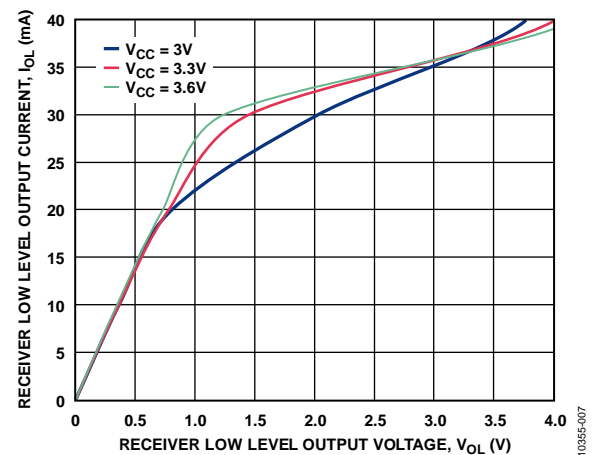

Figure 7. Receiver Output Current vs. Output Voltage (Output Low) ($T_A = 25^\circ\text{C}$)

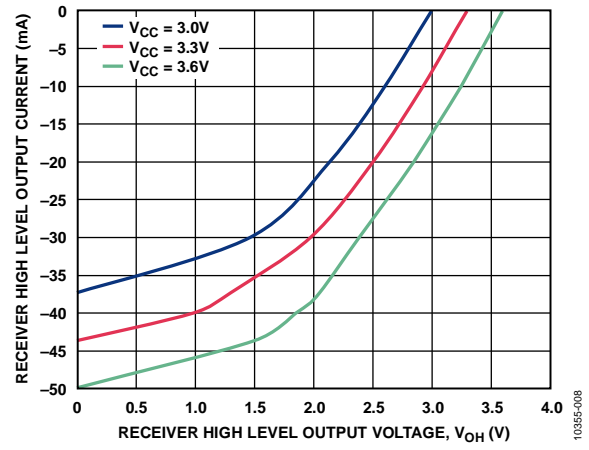

Figure 8. Receiver Output Current vs. Output Voltage (Output High) ($T_A = 25^\circ\text{C}$)

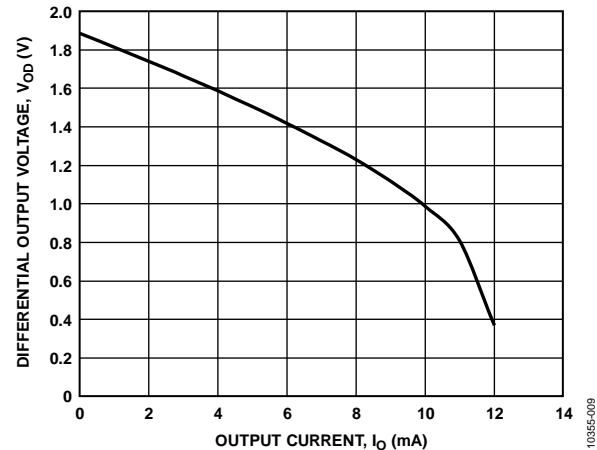

Figure 9. Driver Differential Output Voltage vs. Output Current ($V_{CC} = 3.3\text{ V}$, $T_A = 25^\circ\text{C}$)

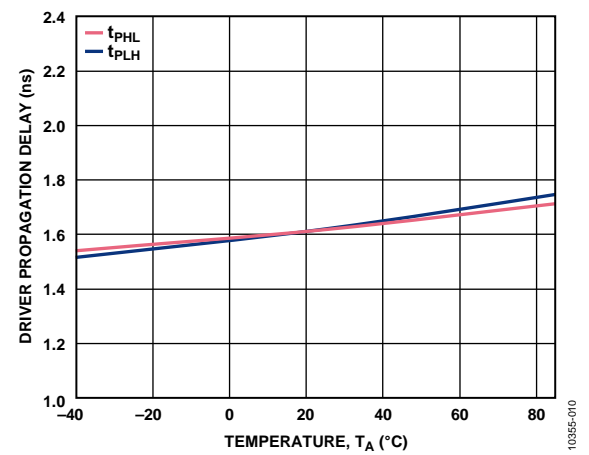

Figure 10. Driver Propagation Delay vs. Temperature (Data Rate = 2 Mbps, $V_{CC} = 3.3\text{ V}$)

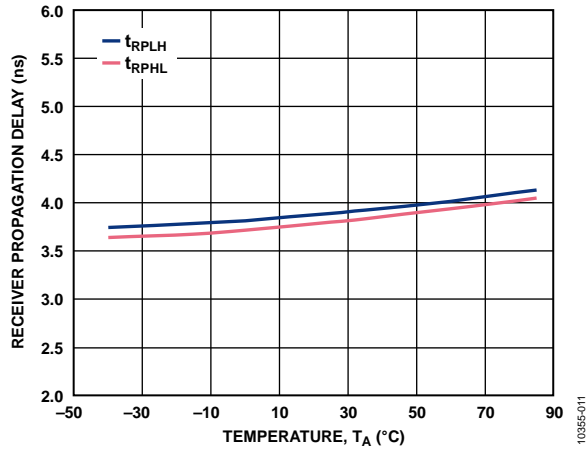

Figure 11. Receiver Propagation Delay vs. Temperature
(Data Rate = 2 Mbps, $V_{CC} = 3.3$ V, $V_{ID} = 400$ mV, $V_{IC} = 1.1$ V)

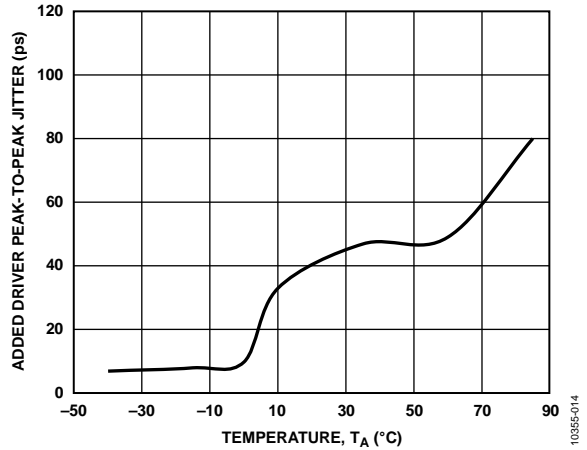

Figure 14. Driver Jitter (Peak-to-Peak) vs. Temperature
(Data Rate = 200 Mbps, $V_{CC} = 3.3$ V, PRBS $2^{15} - 1$ Input)

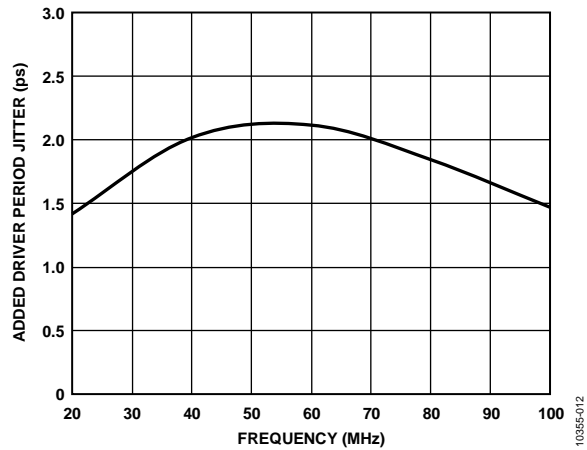

Figure 12. Driver Jitter (Period) vs. Frequency
($V_{CC} = 3.3$ V, $T_A = 25^\circ\text{C}$, Clock Input)

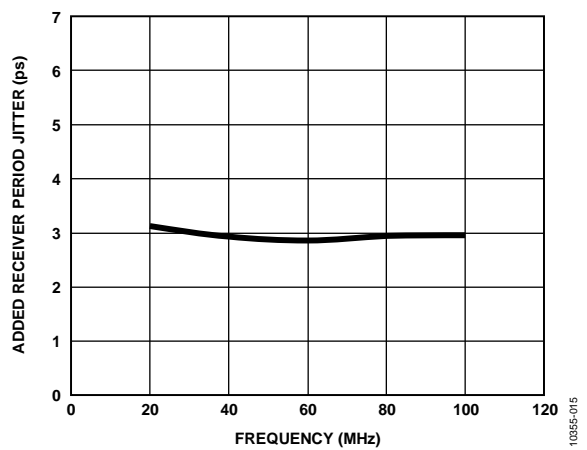

Figure 15. Receiver Jitter (Period) vs. Frequency
($V_{CC} = 3.3$ V, $T_A = 25^\circ\text{C}$, $V_{ID} = 400$ mV)

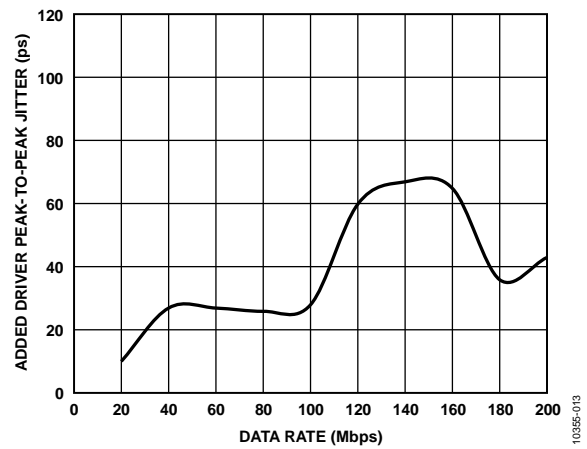

Figure 13. Driver Jitter (Peak-to-Peak) vs. Data Rate
($V_{CC} = 3.3$ V, $T_A = 25^\circ\text{C}$, PRBS $2^{15} - 1$ Input)

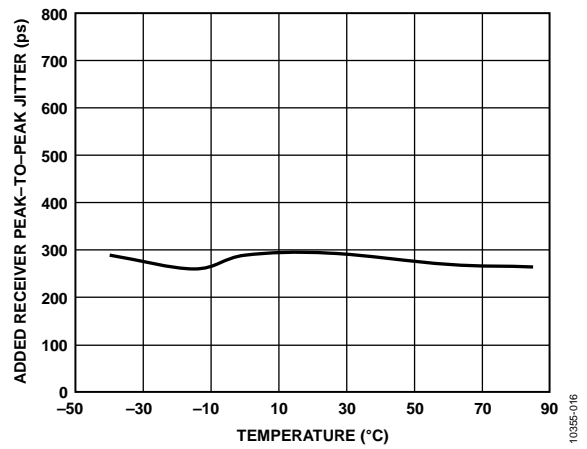

Figure 16. Receiver Jitter (Peak-to-Peak) vs. Temperature
(Data Rate = 200 Mbps, $V_{CC} = 3.3$ V, $V_{ID} = 400$ mV, $V_{IC} = 1.1$ V, PRBS $2^{15} - 1$ Input)

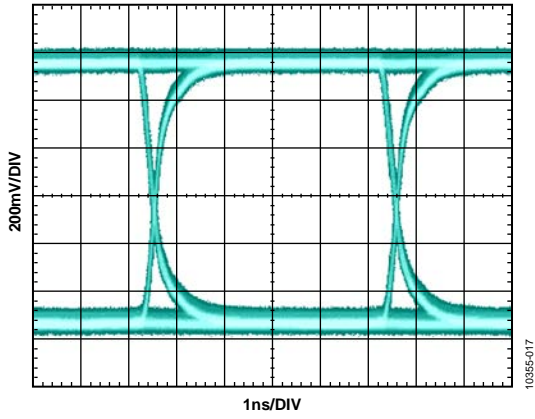

Figure 17. ADN4696E Driver Output Eye Pattern
(Data Rate = 200 Mbps, PRBS $2^{15} - 1$ Input, $R_L = 50 \Omega$)

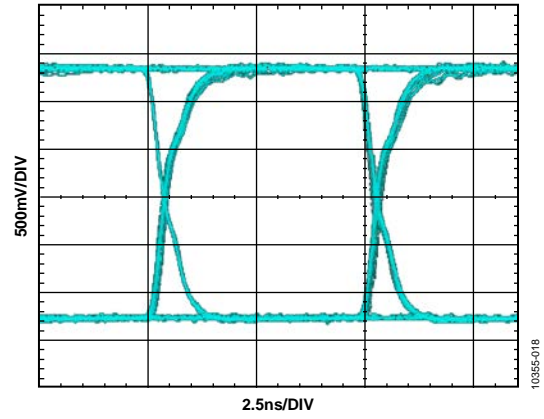
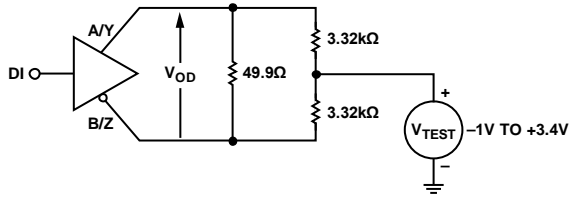

Figure 18. ADN4696E Receiver Output Eye Pattern
(Data Rate = 200 Mbps, PRBS $2^{15} - 1$ Input, $C_L = 15 \text{ pF}$)

TEST CIRCUITS AND SWITCHING CHARACTERISTICS

DRIVER VOLTAGE AND CURRENT MEASUREMENTS



NOTES
1. 1% TOLERANCE FOR ALL RESISTORS

Figure 19. Driver Voltage Measurement over Common-Mode Range

10355-019

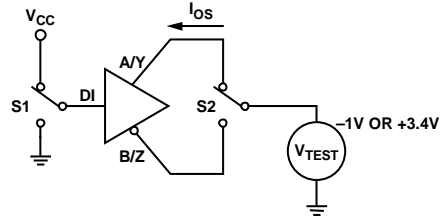
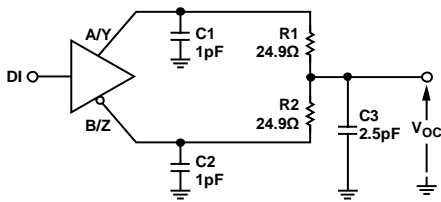

Figure 22. Driver Short Circuit

10355-022



NOTES
1. C1, C2, AND C3 ARE 20% AND INCLUDE PROBE/STRAY CAPACITANCE LESS THAN 2cm FROM DUT.
2. R1 AND R2 ARE 1%, METAL FILM, SURFACE MOUNT, LESS THAN 2cm FROM DUT.

Figure 20. Driver Common-Mode Output Voltage Measurement

10355-020

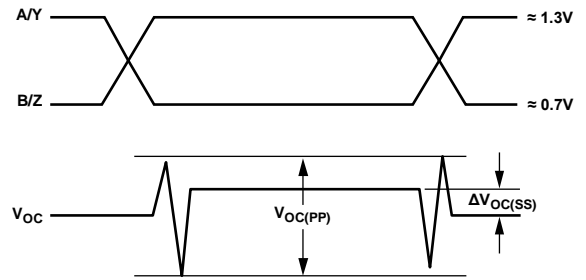

NOTES
1. INPUT PULSE GENERATOR: 500kHz; 50% ± 5% DUTY CYCLE; $t_R, t_F \leq 1\text{ns}$.
2. $V_{OC(PP)}$ MEASURED ON TEST EQUIPMENT WITH -3dB BANDWIDTH $\geq 1\text{GHz}$.

Figure 23. Driver Common-Mode Output Voltage (Steady State)

10355-023

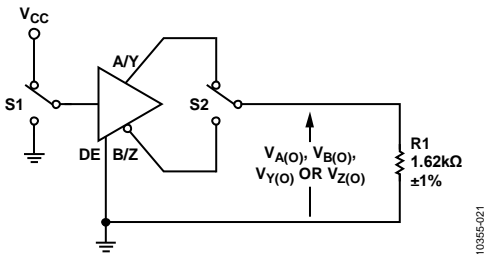
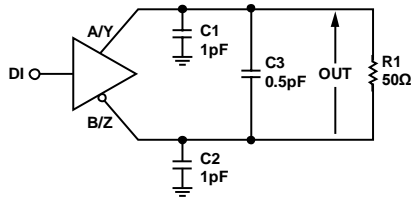

Figure 21. Maximum Steady-State Output Voltage Measurement

10355-021

DRIVER TIMING MEASUREMENTS



- NOTES**
1. C1, C2, AND C3 ARE 20% AND INCLUDE PROBE/STRAY CAPACITANCE LESS THAN 2cm FROM DUT.
 2. R1 IS 1%, METAL FILM, SURFACE MOUNT, LESS THAN 2cm FROM DUT.

Figure 24. Driver Timing Measurement

10395-024

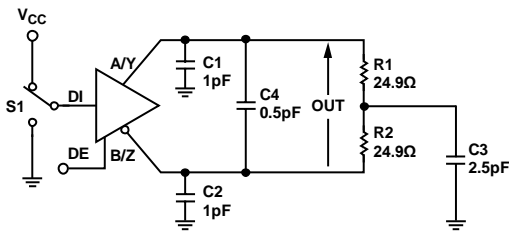

- NOTES**
1. C1, C2, C3, AND C4 ARE 20% AND INCLUDE PROBE/STRAY CAPACITANCE LESS THAN 2cm FROM DUT.
 2. R1 AND R2 ARE 1%, METAL FILM, SURFACE MOUNT, LESS THAN 2cm FROM DUT.

Figure 25. Driver Enable/Disable Time

10395-025

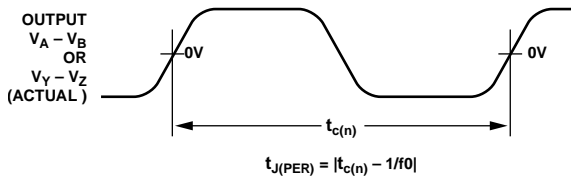
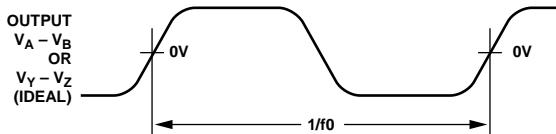
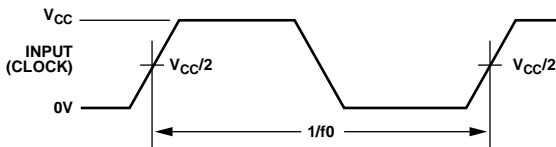

- NOTES**
1. INPUT PULSE GENERATOR: AGILENT 8304A STIMULUS SYSTEM; 100MHz; 50% ± 1% DUTY CYCLE.
 2. MEASURED USING TEK TDS6604 WITH TDSJIT3 SOFTWARE.

Figure 26. Driver Period Jitter Characteristics

10395-026

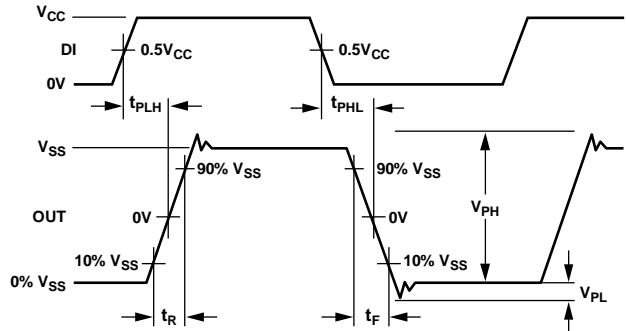

- NOTES**
1. INPUT PULSE GENERATOR: 500kHz; 50% ± 5% DUTY CYCLE; $t_R, t_F \leq 1$ ns.
 2. MEASURED ON TEST EQUIPMENT WITH -3dB BANDWIDTH ≥ 1GHz.

Figure 27. Driver Propagation, Rise/Fall Times and Voltage Overshoot

10395-027

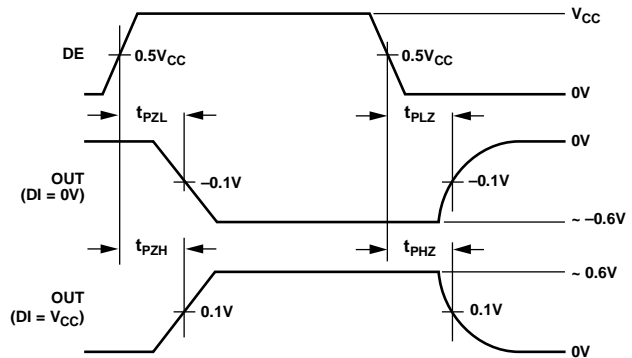

- NOTES**
1. INPUT PULSE GENERATOR: 500kHz; 50% ± 5% DUTY CYCLE; $t_R, t_F \leq 1$ ns.
 2. MEASURED ON TEST EQUIPMENT WITH -3dB BANDWIDTH ≥ 1GHz.

Figure 28. Driver Enable/Disable Times

10395-028

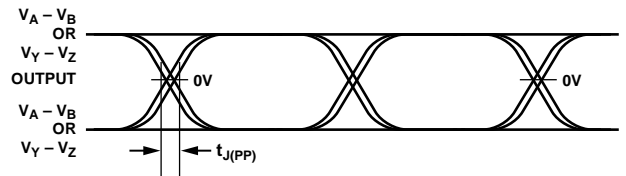
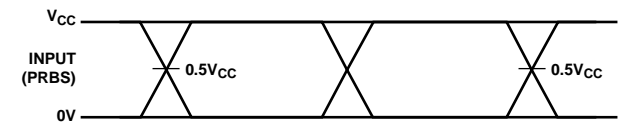

- NOTES**
1. INPUT PULSE GENERATOR: AGILENT 8304A STIMULUS SYSTEM; 200Mbps; 2¹⁵ - 1PRBS.
 2. MEASURED USING TEK TDS6604 WITH TDSJIT3 SOFTWARE.

Figure 29. Driver Peak-to-Peak Jitter Characteristics

10395-029

RECEIVER TIMING MEASUREMENTS

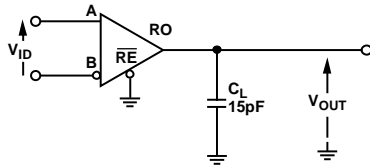

NOTES
 1. C_L IS 20%, CERAMIC, SURFACE MOUNT, AND INCLUDES PROBE/STRAY CAPACITANCE < 2cm FROM DUT.

Figure 30. Receiver Timing Measurement

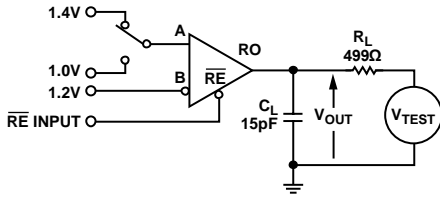

NOTES
 1. C_L IS 20% AND INCLUDES PROBE/STRAY CAPACITANCE < 2cm FROM DUT.
 2. R_L IS 1% METAL FILM, SURFACE MOUNT, < 2cm FROM DUT.

Figure 31. Receiver Enable/Disable Time

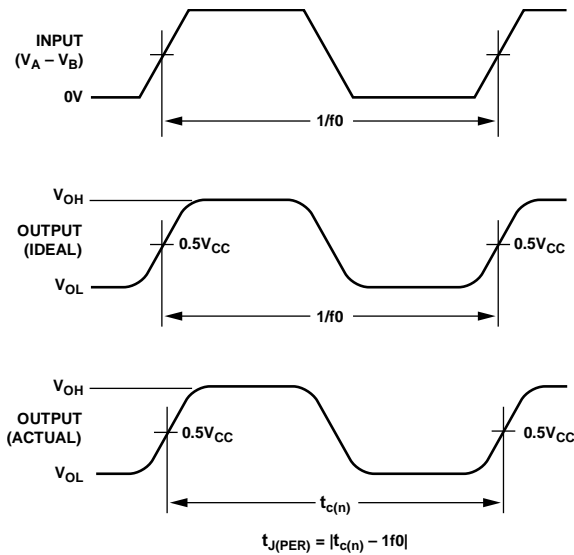

NOTES
 1. INPUT PULSE GENERATOR: AGILENT 8304A STIMULUS SYSTEM; 100MHz; 50% ± 1% DUTY CYCLE.
 2. MEASURED USING TEK TDS6604 WITH TDSJIT3 SOFTWARE.

Figure 32. Receiver Period Jitter Characteristics

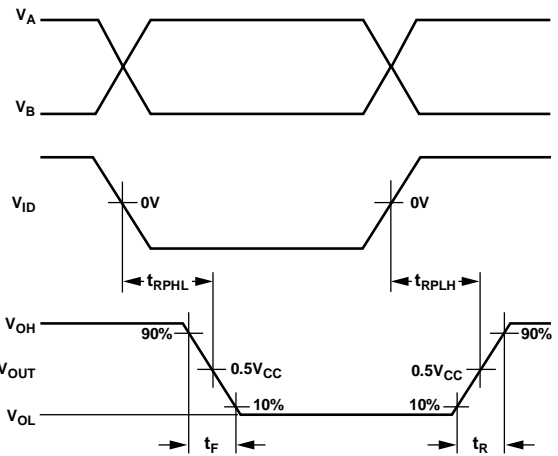

NOTES
 1. INPUT PULSE GENERATOR: 50MHz; 50% ± 5% DUTY CYCLE; $t_R, t_F \leq 1$ ns.
 2. MEASURED ON TEST EQUIPMENT WITH -3dB BANDWIDTH ≥ 1GHz.

Figure 33. Receiver Propagation and Rise/Fall Times

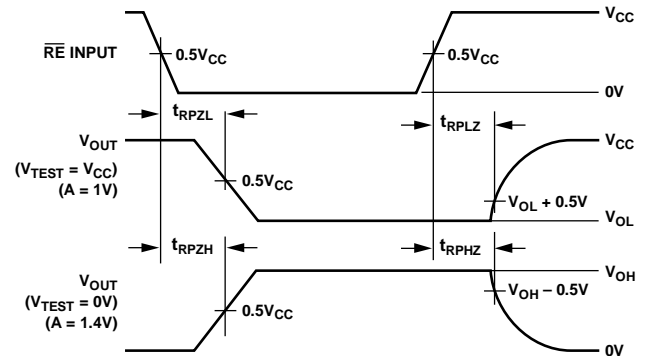

NOTES
 1. INPUT PULSE GENERATOR: 500kHz; 50% ± 5% DUTY CYCLE; $t_R, t_F \leq 1$ ns.

Figure 34. Receiver Enable/Disable Times

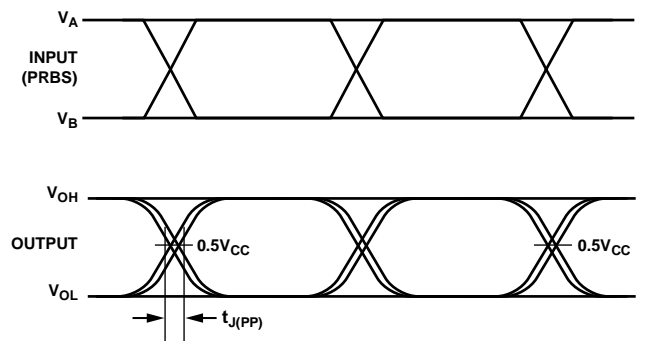

NOTES
 1. INPUT PULSE GENERATOR: AGILENT 8304A STIMULUS SYSTEM; 200Mbps; $2^{15} - 1$ PRBS.
 2. MEASURED USING TEK TDS6604 WITH TDSJIT3 SOFTWARE.

Figure 35. Receiver Peak-to-Peak Jitter Characteristics

THEORY OF OPERATION

The ADN4691E/ADN4693E/ADN4696E/ADN4697E are transceivers for transmitting and receiving multipoint, low voltage differential signaling (M-LVDS) at high speed (data rates up to 200 Mbps). Each device has a differential line driver and a differential line receiver, allowing each device to send and receive data.

Multipoint LVDS expands on the established LVDS low voltage differential signaling method by allowing bidirectional communication between more than two nodes. Up to 32 nodes can connect on an M-LVDS bus.

HALF-DUPLEX/FULL-DUPLEX OPERATION

Half-duplex operation allows a transceiver to transmit or receive, but not both at the same time. However, with full-duplex operation, a transceiver can transmit and receive simultaneously. The ADN4691E/ADN4696E are half-duplex devices in which the driver and the receiver share differential bus terminals. The ADN4693E/ADN4697E are full-duplex devices that have dedicated driver output and receiver input pins. Figure 37 and Figure 38 show typical half- and full-duplex bus topologies, respectively, for M-LVDS.

THREE-STATE BUS CONNECTION

The outputs of the device can be placed in a high impedance state by disabling the driver or receiver. This allows several driver outputs to connect to a single M-LVDS bus. Note that, on each bus line, only one driver can be enabled at a time, but many receivers can be enabled at the same time.

The driver can be enabled or disabled using the driver enable pin (DE). DE enables the driver outputs when taken high; when taken low, DE puts the driver outputs into a high impedance state. Similarly, an active low receiver enable pin ($\overline{\text{RE}}$) controls the receiver. Taking $\overline{\text{RE}}$ low enables the receiver, whereas taking it high puts the receiver outputs into a high impedance state.

Truth tables for driver and receiver output states under various conditions are shown in Table 10, Table 11, Table 12, and Table 13.

TRUTH TABLES

Table 9. Truth Table Abbreviations

Abbreviation	Description
H	High level
L	Low level
X	Don't care
I	Indeterminate
Z	High impedance (off)
NC	Disconnected

Driver, Half-Duplex (ADN4691E/ADN4696E)

Table 10. Transmitting (See Table 9 for Abbreviations)

Power	Inputs		Outputs	
	DE	DI	A	B
Yes	H	H	H	L
Yes	H	L	L	H
Yes	H	NC	L	H
Yes	L	X	Z	Z
Yes	NC	X	Z	Z
≤1.5 V	X	X	Z	Z

Driver, Full-Duplex (ADN4693E/ADN4697E)

Table 11. Transmitting (See Table 9 for Abbreviations)

Power	Inputs		Outputs	
	DE	DI	Y	Z
Yes	H	H	H	L
Yes	H	L	L	H
Yes	H	NC	L	H
Yes	L	X	Z	Z
Yes	NC	X	Z	Z
≤1.5 V	X	X	Z	Z

Type 1 Receiver (ADN4691E/ADN4693E)

Table 12. Receiving (see Table 9 for Abbreviations)

Power	Inputs		Output	
	A – B	$\overline{\text{RE}}$	RO	
Yes	≥50 mV	L	H	
Yes	≤–50 mV	L	L	
Yes	–50 mV < A – B < 50 mV	L	I	
Yes	NC	L	I	
Yes	X	H	Z	
Yes	X	NC	Z	
No	X	X	Z	

Type 2 Receiver (ADN4696E/ADN4697E)

Table 13. Receiving (See Table 9 for Abbreviations)

Power	Inputs		Output	
	A – B	$\overline{\text{RE}}$	RO	
Yes	≥150 mV	L	H	
Yes	≤50 mV	L	L	
Yes	50 mV < A – B < 150 mV	L	I	
Yes	NC	L	L	
Yes	X	H	Z	
Yes	X	NC	Z	
No	X	X	Z	

GLITCH-FREE POWER-UP/POWER-DOWN

To minimize disruption to the bus when adding nodes, the M-LVDS outputs of the device are kept glitch-free when the device is powering up or down. This feature allows insertion of devices onto a live M-LVDS bus because the bus outputs are not switched on before the device is fully powered. In addition, all outputs are placed in a high impedance state when the device is powered off.

FAULT CONDITIONS

The ADN4691E/ADN4693E/ADN4696E/ADN4697E contain short-circuit current protection that protects the device under fault conditions in the case of short circuits on the bus. This protection limits the current in a fault condition to 24 mA at the transmitter outputs for short-circuit faults between -1 V and 3.4 V. Any network fault must clear to avoid data transmission errors and to ensure reliable operation of the data network and any devices that are connected to the network.

RECEIVER INPUT THRESHOLDS/FAIL-SAFE

Two receiver types are available, both of which incorporate protection against short circuits.

The Type 1 receivers of the ADN4691E/ADN4693E incorporate 25 mV of hysteresis. This ensures that slow changing signals or a loss of input does not result in oscillation of the receiver output. Type 1 receiver thresholds are ± 50 mV; therefore, the state of the receiver output is indeterminate if the differential between A and B is about 0 V. This state occurs if the bus is idle (approximately 0 V on both A and B), with no drivers enabled on the attached nodes.

Type 2 receivers (ADN4696E/ADN4697E) have an open circuit and bus-idle fail-safe. The input threshold is offset by 100 mV so a logic low is present on the receiver output when the bus is idle or when the receiver inputs are open.

The different receiver thresholds for the two receiver types are illustrated in Figure 36. See Table 12 and Table 13 for receiver output states under various conditions.

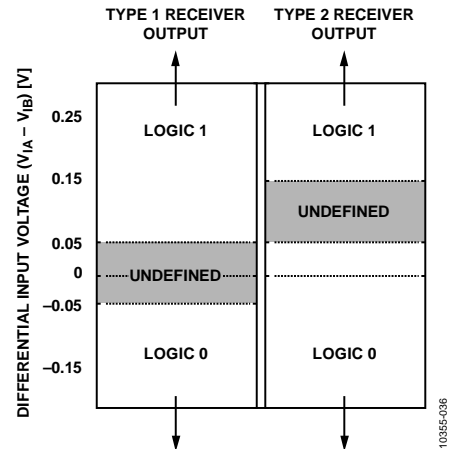

Figure 36. Input Threshold Voltages

APPLICATIONS INFORMATION

M-LVDS extends the low power, high speed, differential signaling of low voltage differential signaling (LVDS) to multipoint systems where multiple nodes are connected over short distances in a bus topology network.

With M-LVDS, a transmitting node drives a differential signal across a transmission medium such as a twisted pair cable. The transmitted differential signal allows other receiving nodes that are connected along the bus to detect a differential voltage that can then be converted back into a single-ended logic signal by the receiver.

The communication line is typically terminated at both ends by resistors (R_T), the value of which is chosen to match the characteristic impedance of the medium (typically 100 Ω).

For half-duplex multipoint applications such as the one shown in Figure 37, only one driver can be enabled at any time. Full-duplex nodes allow a master-slave topology as shown in Figure 38. In this configuration, a master node can concurrently send and receive data to/from slave nodes. At any time, only one slave node can have a driver enabled to concurrently transmit data back to the master node.

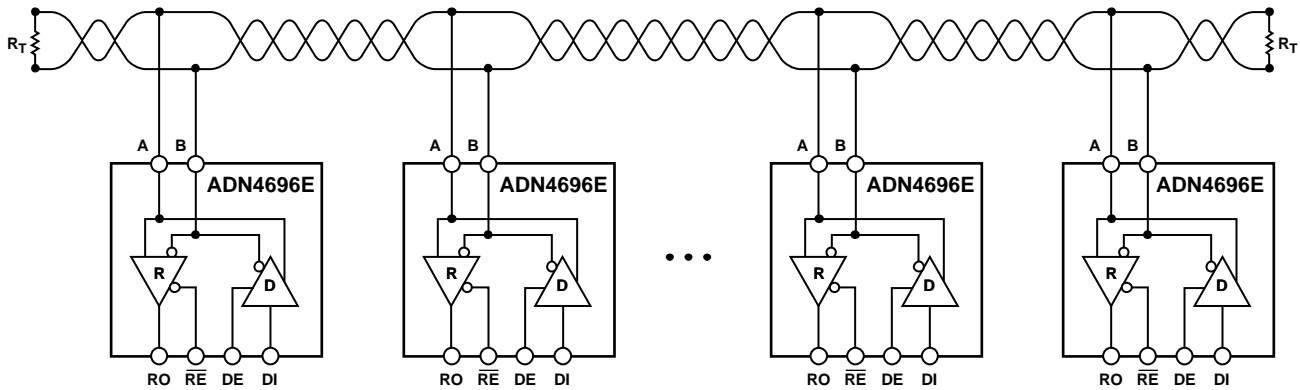

- NOTES
 1. MAXIMUM NUMBER OF NODES: 32.
 2. R_T IS EQUAL TO THE CHARACTERISTIC IMPEDANCE OF THE CABLE USED.

Figure 37. ADN4696E Typical Half-Duplex M-LVDS Network (Type 2 Receivers with Threshold Offset for Bus-Idle Fail-Safe)

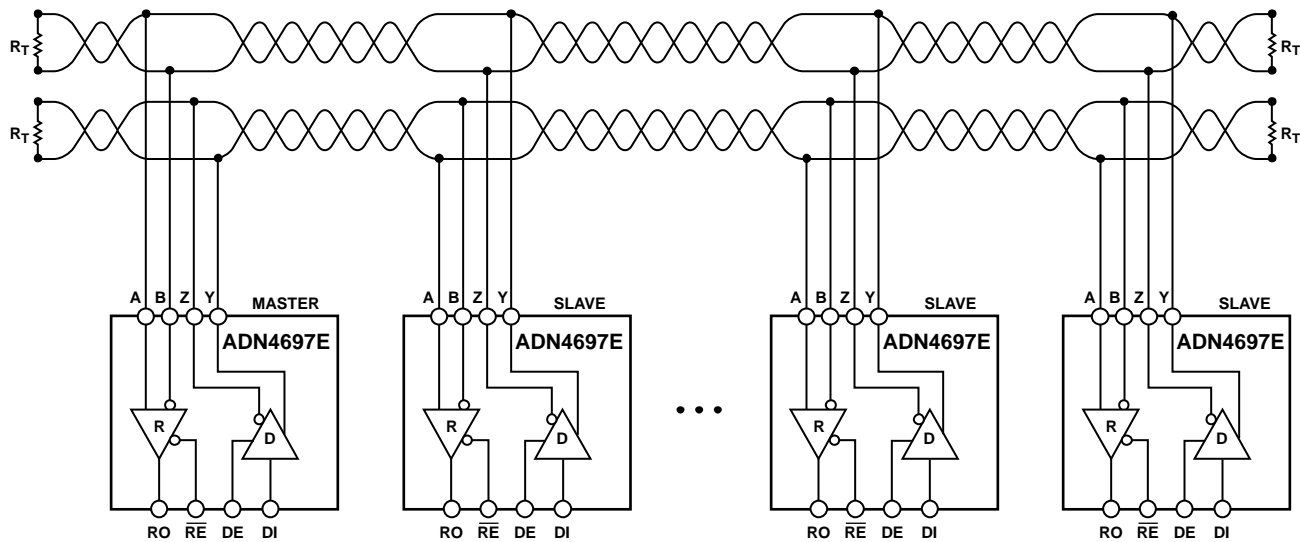

- NOTES
 1. MAXIMUM NUMBER OF NODES: 32.
 2. R_T IS EQUAL TO THE CHARACTERISTIC IMPEDANCE OF THE CABLE USED.

Figure 38. ADN4697E Typical Full-Duplex M-LVDS Master-Slave Network (Type 2 Receivers with Threshold Offset for Bus-Idle Fail-Safe)

OUTLINE DIMENSIONS

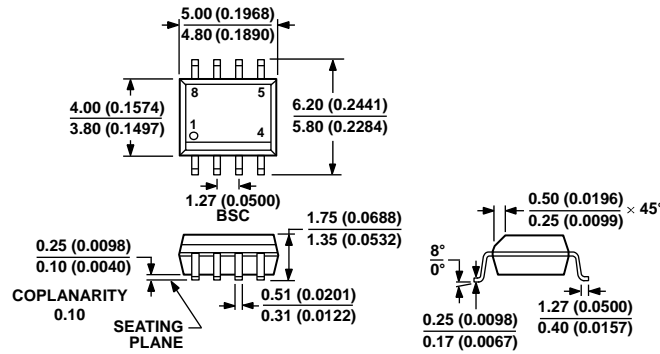

COMPLIANT TO JEDEC STANDARDS MS-012-AA
CONTROLLING DIMENSIONS ARE IN MILLIMETERS; INCH DIMENSIONS (IN PARENTHESES) ARE ROUNDED-OFF MILLIMETER EQUIVALENTS FOR REFERENCE ONLY AND ARE NOT APPROPRIATE FOR USE IN DESIGN.

015407-A

Figure 39. 8-Lead Standard Small Outline Package [SOIC_N] Narrow Body (R-8)

Dimensions shown in millimeters and (inches)

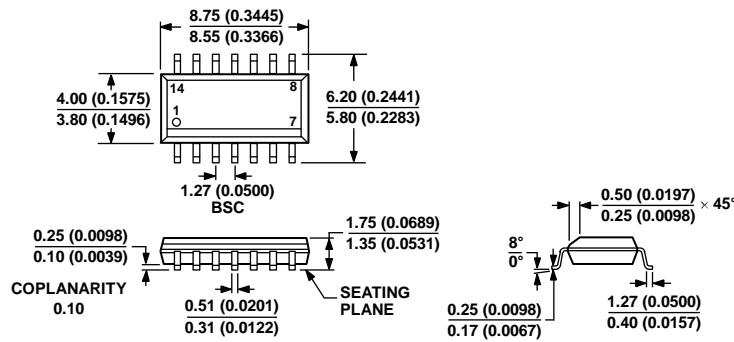

COMPLIANT TO JEDEC STANDARDS MS-012-AB
CONTROLLING DIMENSIONS ARE IN MILLIMETERS; INCH DIMENSIONS (IN PARENTHESES) ARE ROUNDED-OFF MILLIMETER EQUIVALENTS FOR REFERENCE ONLY AND ARE NOT APPROPRIATE FOR USE IN DESIGN.

060806-A

Figure 40. 14-Lead Standard Small Outline Package [SOIC_N] Narrow Body (R-14)

Dimensions shown in millimeters and (inches)

ORDERING GUIDE

Model ¹	Temperature Range	Package Description	Package Option
ADN4691EBRZ	-40°C to +85°C	8-Lead Standard Small Outline Package (SOIC_N)	R-8
ADN4691EBRZ-RL7	-40°C to +85°C	8-Lead Standard Small Outline Package (SOIC_N)	R-8
ADN4693EBRZ	-40°C to +85°C	14-Lead Standard Small Outline Package (SOIC_N)	R-14
ADN4693EBRZ-RL7	-40°C to +85°C	14-Lead Standard Small Outline Package (SOIC_N)	R-14
ADN4696EBRZ	-40°C to +85°C	8-Lead Standard Small Outline Package (SOIC_N)	R-8
ADN4696EBRZ-RL7	-40°C to +85°C	8-Lead Standard Small Outline Package (SOIC_N)	R-8
ADN4697EBRZ	-40°C to +85°C	14-Lead Standard Small Outline Package (SOIC_N)	R-14
ADN4697EBRZ-RL7	-40°C to +85°C	14-Lead Standard Small Outline Package (SOIC_N)	R-14
EVAL-ADN469xEHDEBZ		Evaluation Board for Half-Duplex (ADN4691E/ADN4696E)	
EVAL-ADN469xEFDEBZ		Evaluation Board for Full-Duplex (ADN4693E/ADN4697E)	

¹ Z = RoHS Compliant Part.

NOTES

NOTES

NOTES

Mouser Electronics

Authorized Distributor

Click to View Pricing, Inventory, Delivery & Lifecycle Information:

[Analog Devices Inc.:](#)

[ADN4691EBRZ](#) [ADN4691EBRZ-RL7](#) [ADN4693EBRZ](#) [ADN4693EBRZ-RL7](#) [ADN4696EBRZ](#) [ADN4696EBRZ-RL7](#)
[ADN4697EBRZ](#) [ADN4697EBRZ-RL7](#) [EVAL-ADN469XEFDEBZ](#) [EVAL-ADN469XEHDEBZ](#)