

# 92x92x25 mm

San Cooler 92 9A type   



## General Specifications

- Material ..... Frame: Plastic (Flammability: UL 94V-0), Impeller: Plastic (Flammability: UL 94V-0)
- Expected life ..... See the table below. (L10 life: 90% survival rate for continuous operation in free air at 60°C, rated voltage)
- Motor protection function ..... Locked rotor burnout protection, Reverse polarity protection  
For details, please refer to p. 547.
- Dielectric strength ..... 50/60 Hz, 500 VAC, for 1 minute (between lead wire conductors and frame)
- Insulation resistance ..... 10 MΩ or more with a 500 VDC megger (between lead wire conductors and frame)
- Sound pressure level (SPL) ..... At 1 m away from the air inlet
- Storage temperature ..... -30 to +70°C (Non-condensing)
- Lead wire ..... ⊕Red ⊖Black or Blue (Sensor) Yellow
- Mass ..... 100 g

## Specifications

The models listed below **have ribs and pulse sensors.** For models without ribs, append "1" to the end of model numbers.

Model no.	Rated voltage [V]	Operating voltage range [V]	Rated current [A]	Rated input [W]	Rated speed [min <sup>-1</sup> ]	Max. airflow [m <sup>3</sup> /min] [CFM]	Max. static pressure [Pa] [inchH <sub>2</sub> O]	SPL [dB (A)]	Operating temperature [°C]	Expected life [h]
9A0912G401	12	6 to 13.8	0.39	4.68	3900	1.76 62.1	66.5 0.267	43	-20 to +60	30000/60°C
9A0912S401			0.27	3.24	3550	1.66 58.6	56.1 0.225	39		
9A0912H401			0.21	2.52	3150	1.45 51.2	44 0.177	33	-20 to +70	
9A0912F401			0.14	1.68	2650	1.24 43.8	32.2 0.129	30		
9A0912M401			0.12	1.44	2250	1.04 36.7	22.6 0.091	27		
9A0912L401			0.07	0.84	1750	0.8 28.2	13.4 0.054	23		
9A0924G401	24	12 to 27.6	0.19	4.56	3900	1.76 62.1	66.5 0.267	43	-20 to +60	40000/60°C
9A0924S401			0.15	3.6	3550	1.66 58.6	56.1 0.225	39		
9A0924H401			0.1	2.4	3150	1.45 51.2	44 0.177	33	-20 to +70	
9A0924F401			0.08	1.92	2650	1.24 43.8	32.2 0.129	30		
9A0924M401			0.05	1.2	2250	1.04 36.7	22.6 0.091	27		
9A0924L401			0.04	0.96	1750	0.8 28.2	13.4 0.054	23		
9A0948S401	48	40.5 to 53	0.08	3.84	3550	1.66 58.6	56.1 0.225	39	-20 to +60	

The following sensor and control options are available for selection.

Available for all models. **Without sensor**

Differs according to the model. Refer to the table on p. 566. **Lock sensor** **PWM control**

## Airflow - Static Pressure Characteristics

**9A0912G401** With pulse sensor

Operating voltage range

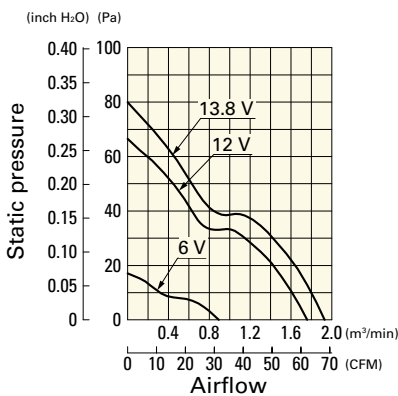

**9A0912S401** With pulse sensor

Operating voltage range

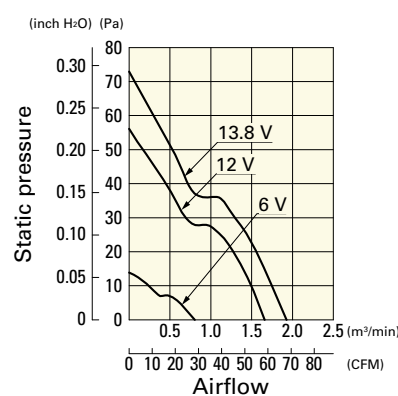

**9A0912H401** With pulse sensor

Operating voltage range

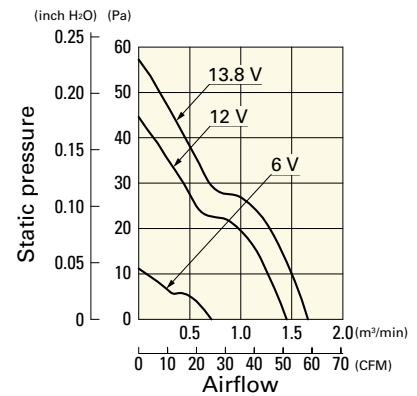

# Airflow - Static Pressure Characteristics

**9A0912F401** With pulse sensor

Operating voltage range

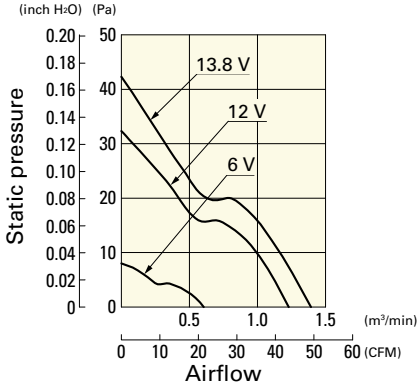

**9A0912M401** With pulse sensor

Operating voltage range

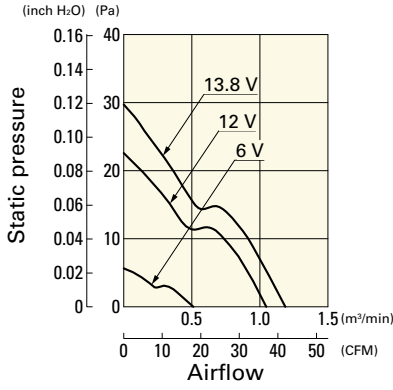

**9A0912L401** With pulse sensor

Operating voltage range

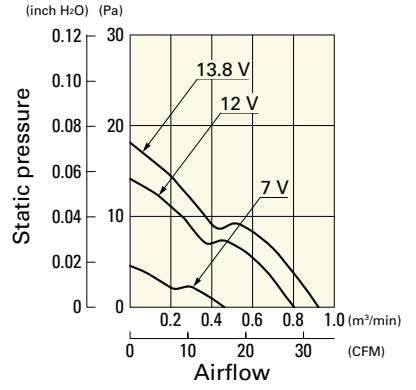

**9A0924G401** With pulse sensor

Operating voltage range

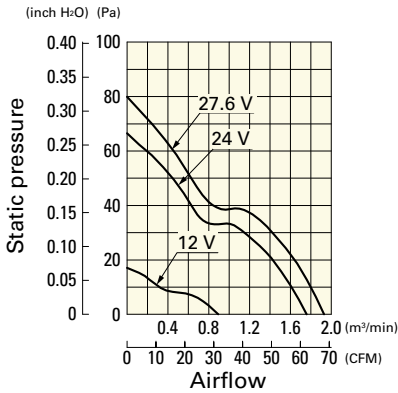

**9A0924S401** With pulse sensor

Operating voltage range

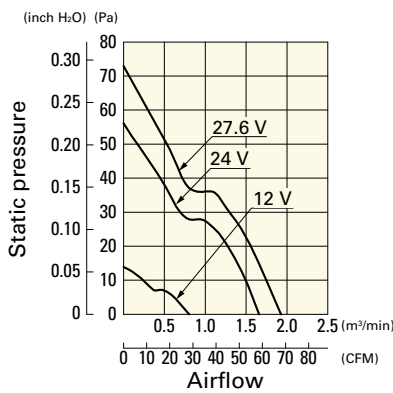

**9A0924H401** With pulse sensor

Operating voltage range

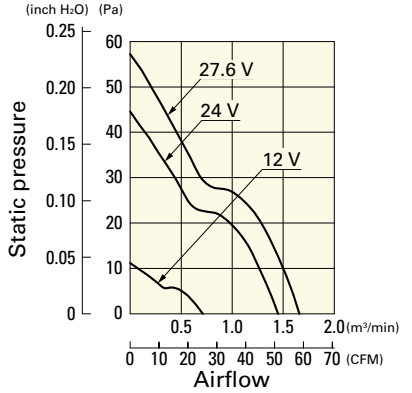

**9A0924F401** With pulse sensor

Operating voltage range

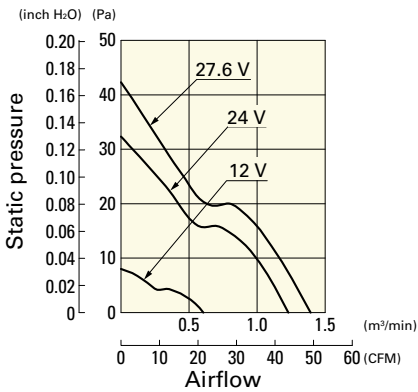

**9A0924M401** With pulse sensor

Operating voltage range

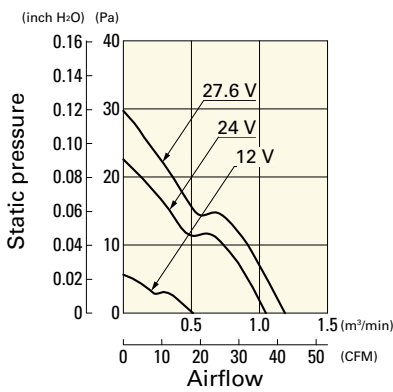

**9A0924L401** With pulse sensor

Operating voltage range

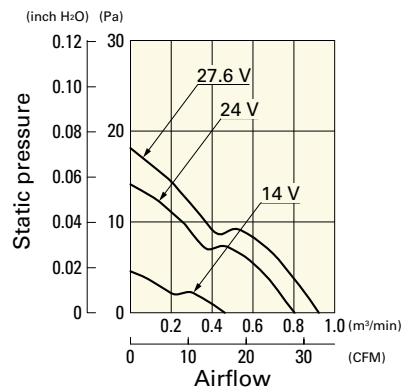

**9A0948S401** With pulse sensor

Operating voltage range

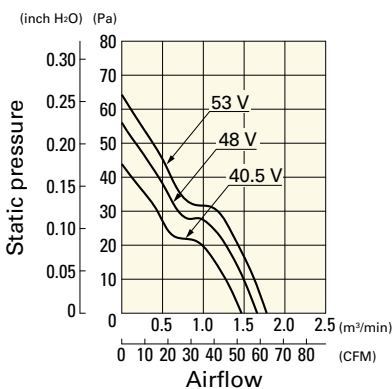

**Dimensions (unit: mm)** (With ribs)

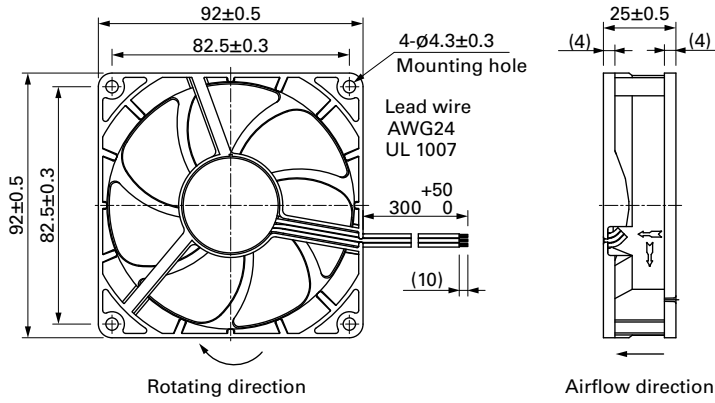

**Reference Dimensions of Mounting Holes and Vent Opening (unit: mm)**

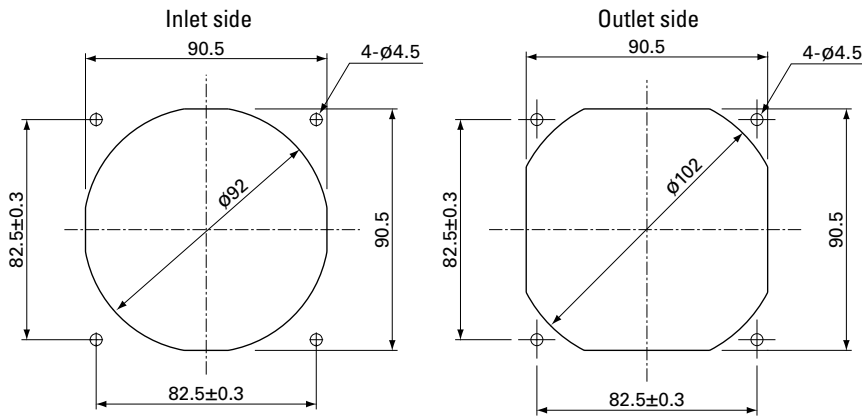

**Options**

**Finger guards**

page: p. 532

Model no.: 109-099E, 109-099H, 109-099C

**Resin finger guards**

page: p. 539

Model no.: 109-1001G

**Resin filter kits**

page: p. 540

Model no.: 109-1001F13 (13PPI), 109-1001F20 (20PPI),  
109-1001F30 (30PPI), 109-1001F40 (40PPI)

# Mouser Electronics

Authorized Distributor

Click to View Pricing, Inventory, Delivery & Lifecycle Information:

## Sanyo Denki:

[9A0912G402](#) [9A0924S4021](#) [9A0912H401](#) [9A0912H4011](#) [9A0924F4011](#) [9A0924H401](#) [9A0924S401](#)  
[9A0924S4011](#) [9AH0912P4G03](#) [9AH0912P4H03](#) [9A0912S4011](#) [9A0912M4011](#) [9A0924H402](#) [9A0924S402](#)  
[9A0912S402](#) [9A0912M4021](#) [9A0912G4011](#) [9A0912G4021](#) [9A0912G401](#) [9A0924G401](#) [9A0912S401](#) [9A0924M4011](#)  
[9A0924H4011](#) [9A0924M401](#) [9A0912F4011](#) [9A0912M401](#) [9A0924G4011](#) [9A0912L4011](#) [9A0912F401](#)  
[9A0924F401](#) [9A0924L401](#) [9A0924L4011](#) [9A0912L401](#) [9A0948S4011](#) [9A0948S401](#) [9A0924L4D01](#) [9A0924G4021](#)  
[9A0924M4021](#) [9A0924M4D011](#) [9A0912M4D011](#) [9A0924M4D01](#) [9A0912H402](#) [9A0912H4D011](#) [9A0912L402](#)  
[9A0924H4021](#) [9A0912L4D01](#) [9A0912M4D01](#) [9A0912F4021](#) [9A0912H4D01](#) [9A0912S4021](#) [9A0924L402](#)  
[9A0924M402](#) [9A0912F402](#) [9A0912H4021](#) [9A0924G4D01](#) [9A0912L4021](#) [9A0912L4D011](#) [9A0912G4D01](#)  
[9A0924G402](#) [9A0924F4021](#) [9A0924S4D01](#) [9A0924F4D01](#) [9A0912S4D01](#) [9A0924F4D011](#) [9A0924S4D011](#)  
[9A0924H4D011](#) [9A0924L4D011](#) [9A0924H4D01](#) [9A0912F4D01](#) [9A0912G4D011](#) [9A0912F4D011](#) [9A0912M402](#)  
[9A0912S4D011](#) [9A0924F402](#) [9A0924L4021](#) [9A0948S402](#) [9A0948S4021](#) [9A0948S4D01](#)