

LOW DROP POWER SCHOTTKY RECTIFIER

MAJOR PRODUCTS CHARACTERISTICS

$I_{F(AV)}$	2 x 20 A
V_{RRM}	30 V
$T_j(\text{max})$	150°C
$V_F(\text{max})$	0.40 V

FEATURES AND BENEFITS

- VERY SMALL CONDUCTION LOSSES
- NEGLIGIBLE SWITCHING LOSSES
- EXTREMELY FAST SWITCHING
- LOW FORWARD VOLTAGE DROP FOR HIGHER EFFICIENCY
- LOW THERMAL RESISTANCE
- AVALANCHE CAPABILITY SPECIFIED

DESCRIPTION

Dual Schottky rectifier suited for switch Mode Power Supply and high frequency DC to DC converters.

Packaged in TO-220AB, D²PAK and I²PAK, this device is intended for use in low voltage high frequency inverters, free wheeling and polarity protection applications.

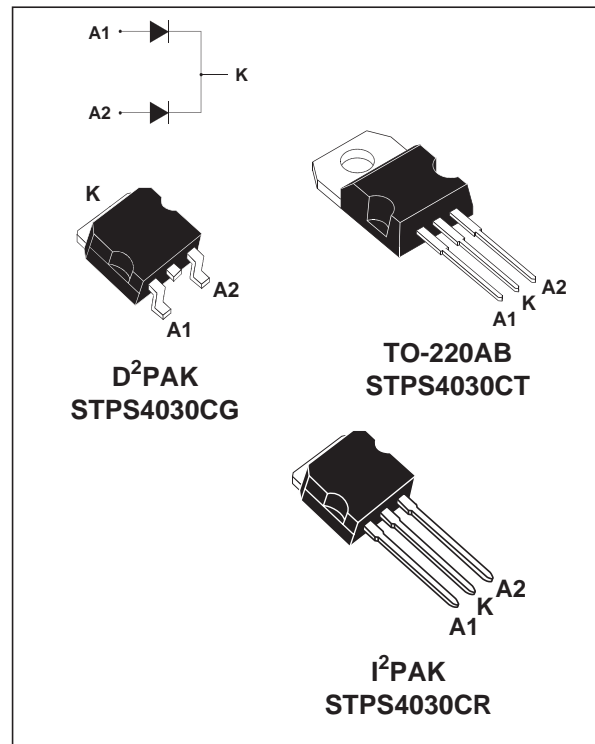

ABSOLUTE RATINGS (limiting values, per diode)

Symbol	Parameter		Value	Unit
V_{RRM}	Repetitive peak reverse voltage		30	V
$I_{F(RMS)}$	RMS forward current		32	A
$I_{F(AV)}$	Average forward current	$T_c = 130^\circ\text{C}$ $\delta = 0.5$	Per diode 40 Per device	A
I_{FSM}	Surge non repetitive forward current	$t_p = 10 \text{ ms}$ Sinusoidal	220	A
I_{RRM}	Peak repetitive reverse current	$t_p = 2 \mu\text{s}$ square $F = 1\text{kHz}$	2	A
P_{ARM}	Repetitive peak avalanche power	$t_p = 1 \mu\text{s}$ $T_j = 25^\circ\text{C}$	5300	W
T_{stg}	Storage temperature range		- 65 to + 150	°C
T_j	Maximum operating junction temperature *		150	°C
dV/dt	Critical rate of rise of reverse voltage (rated V_R , $T_j = 25^\circ\text{C}$)		10000	V/ μs

* : $\frac{dP_{tot}}{dT_j} < \frac{1}{R_{th}(j-a)}$ thermal runaway condition for a diode on its own heatsink

STPS4030CT/CG/CR

THERMAL RESISTANCES

Symbol	Parameter		Value	Unit
$R_{th(j-c)}$	Junction to case TO-220AB - D ² PAK - I ² PAK	Per diode	1.6	°C/W
		Total	0.85	
$R_{th(c)}$		Coupling	0.1	°C/W

STATIC ELECTRICAL CHARACTERISTICS (per diode)

Symbol	Parameter	Tests Conditions		Min.	Typ.	Max.	Unit	
I_R^*	Reverse leakage current	$T_j = 25^\circ\text{C}$	$V_R = V_{RRM}$		0.50	1.0	mA	
		$T_j = 125^\circ\text{C}$			170	350		
V_F^*	Forward voltage drop	$T_j = 25^\circ\text{C}$	$I_F = 20\text{ A}$		0.44	0.49	V	
		$T_j = 125^\circ\text{C}$			0.35	0.40		
		$T_j = 25^\circ\text{C}$		$I_F = 40\text{ A}$		0.52		0.61
		$T_j = 125^\circ\text{C}$				0.46		0.55

Pulse test : * $t_p = 380\ \mu\text{s}$, $\delta < 2\%$

To evaluate the conduction losses use the following equation :

$$P = 0.25 \times I_{F(AV)} + 0.0075 I_{F(RMS)}^2$$

Fig. 1: Conduction losses versus average current.

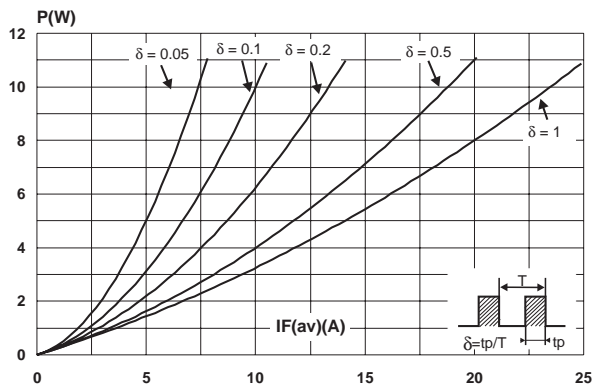

Fig. 3: Normalized avalanche power derating versus pulse duration.

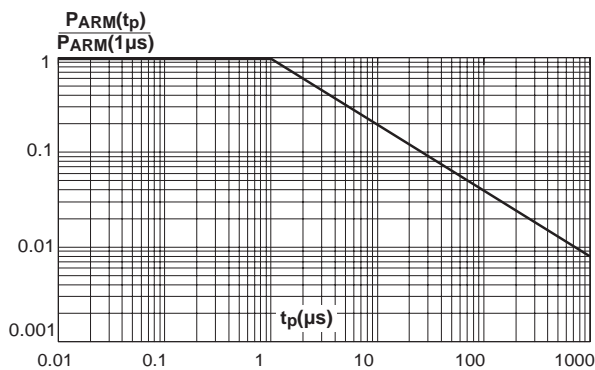

Fig. 2: Average forward current versus ambient temperature ($\delta = 0.5$).

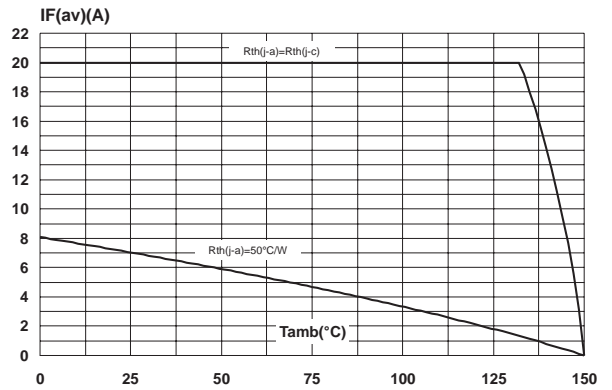

Fig. 4: Normalized avalanche power derating versus junction temperature.

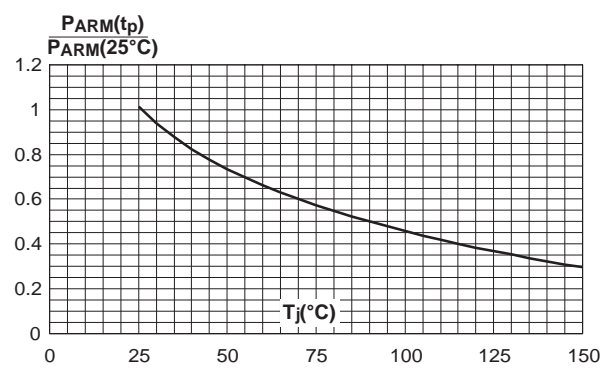

Fig. 5: Non repetitive surge peak forward current versus overload duration (maximum values).

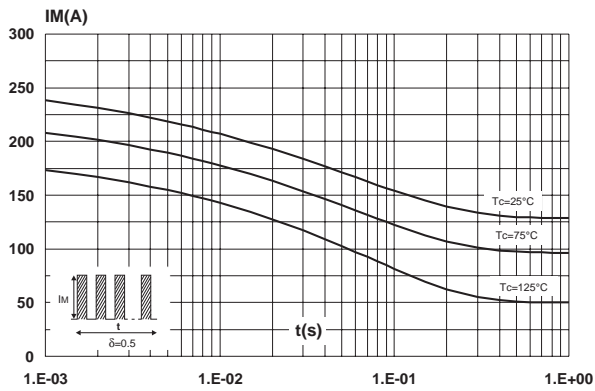

Fig. 6: Relative variation of thermal impedance junction to case versus pulse duration.

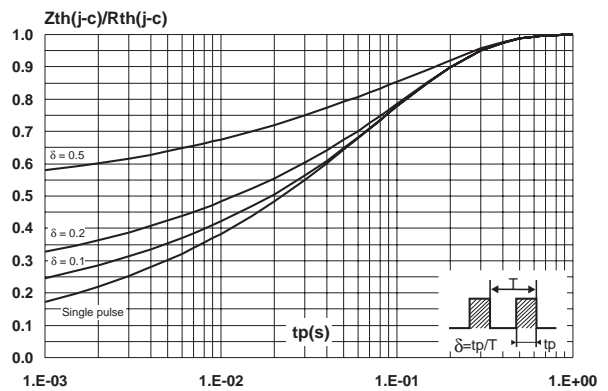

Fig. 7: Reverse leakage current versus reverse voltage applied (typical values).

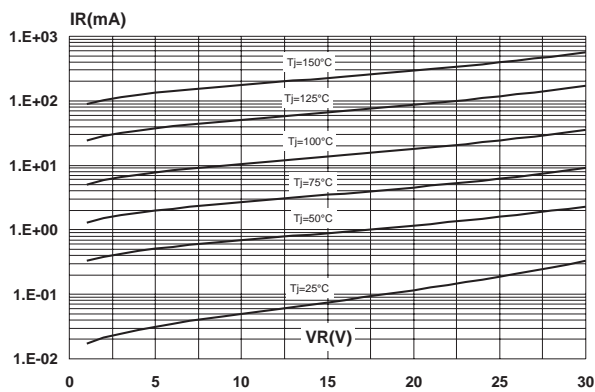

Fig. 8: Junction capacitance versus reverse voltage applied (typical values).

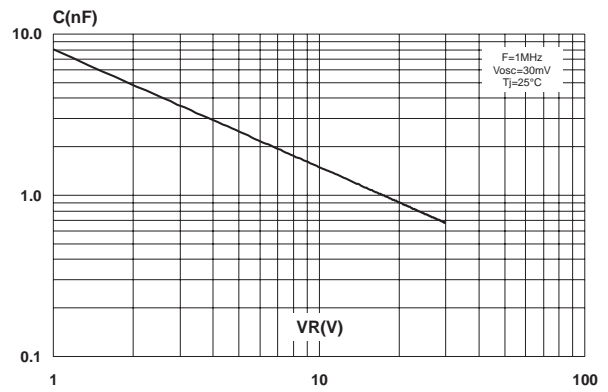

Fig. 9: Forward voltage drop versus forward current.

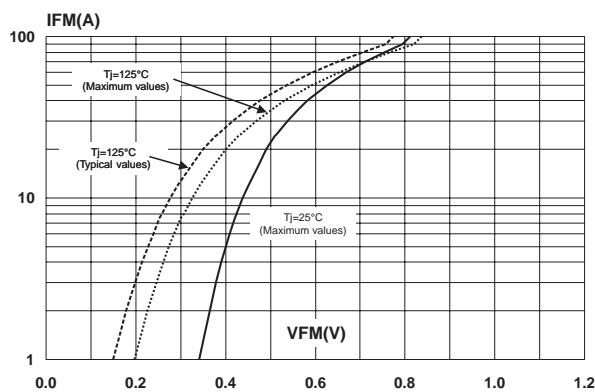
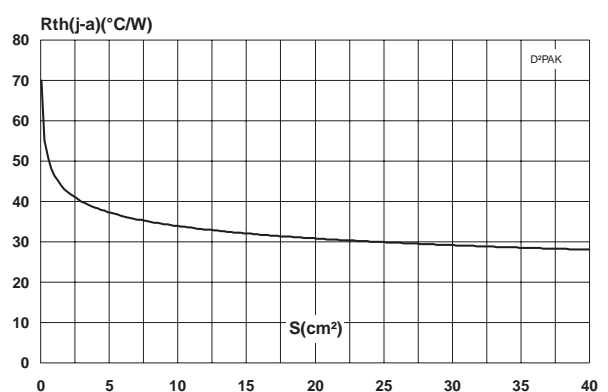
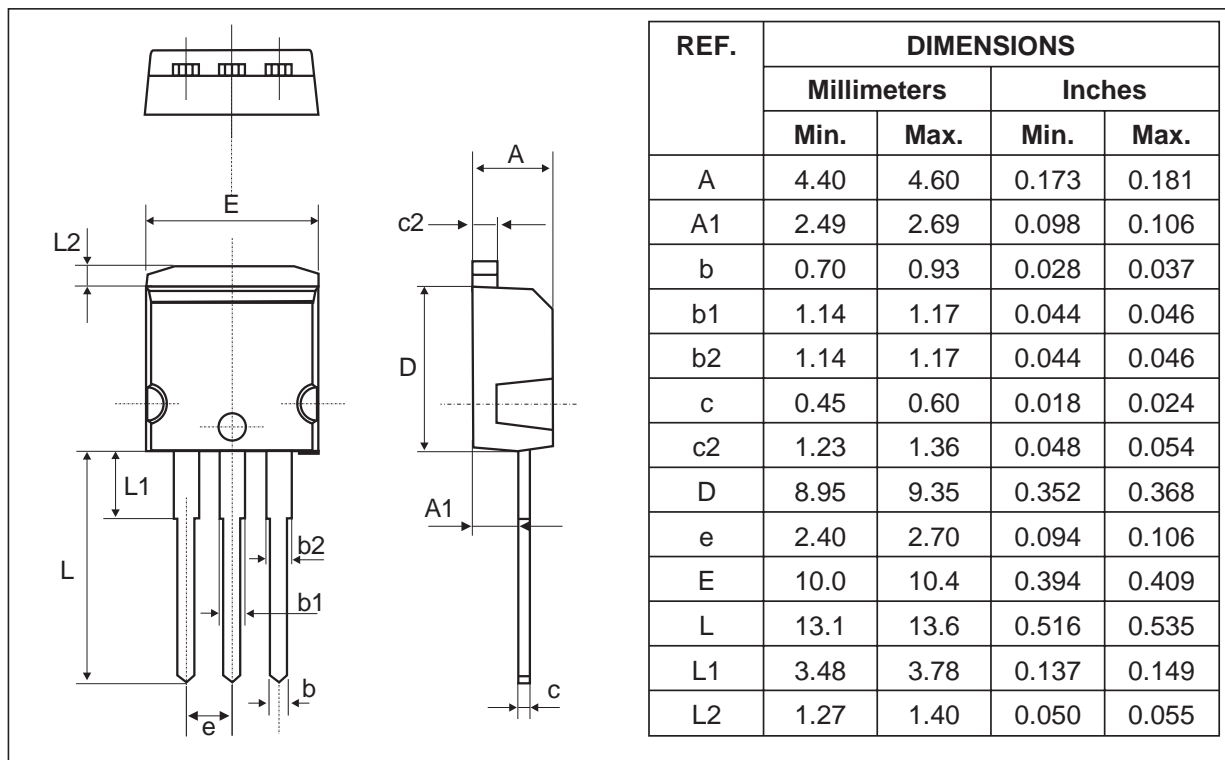

Fig. 10: Thermal resistance junction to ambient versus copper surface under tab (epoxy printed board FR4, Cu = 35µm).



PACKAGE MECHANICAL DATA
I²PAK



PACKAGE MECHANICAL DATA
D²PAK

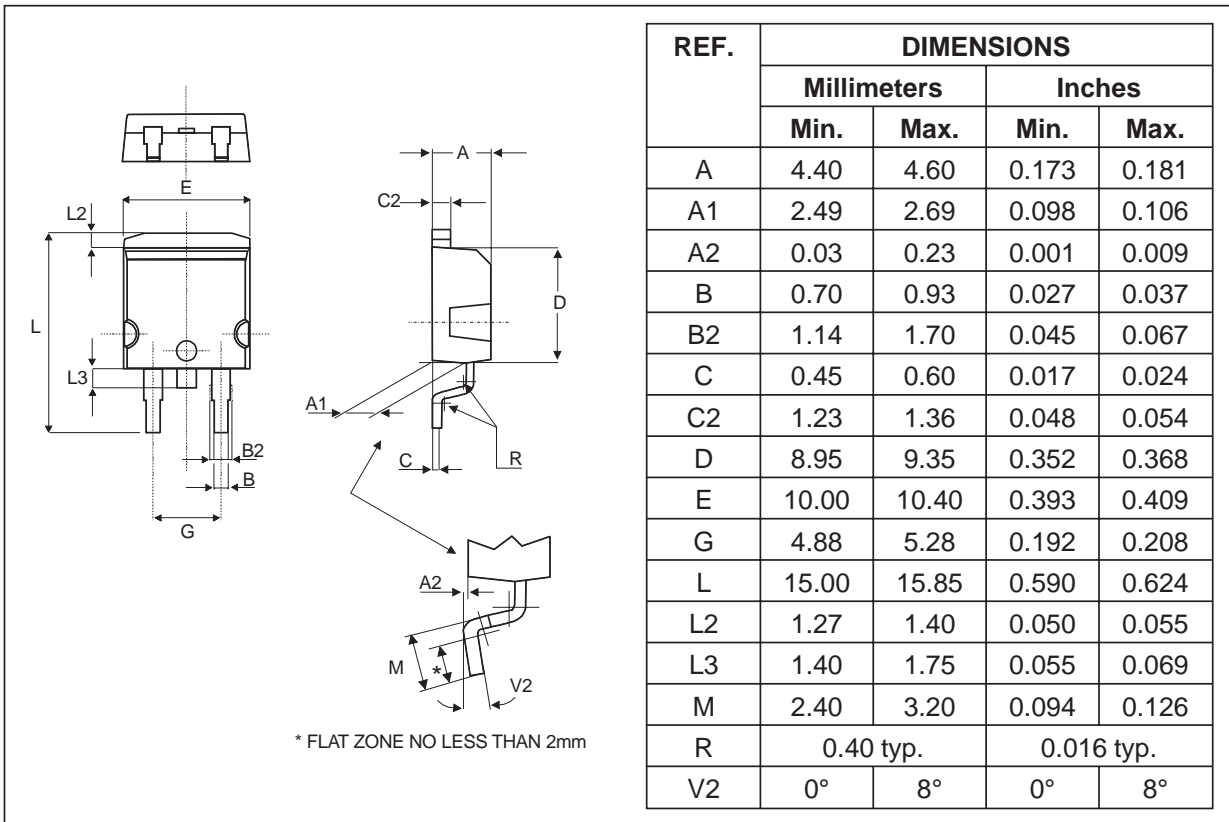

FOOTPRINT

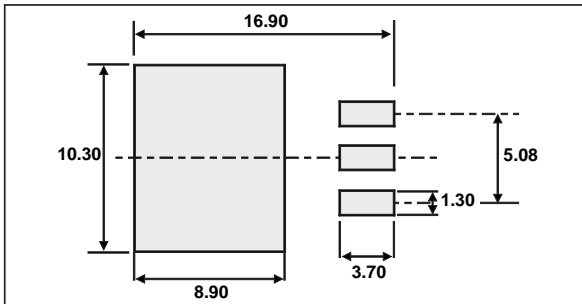

STPS4030CT/CG/CR

PACKAGE MECHANICAL DATA TO-220AB

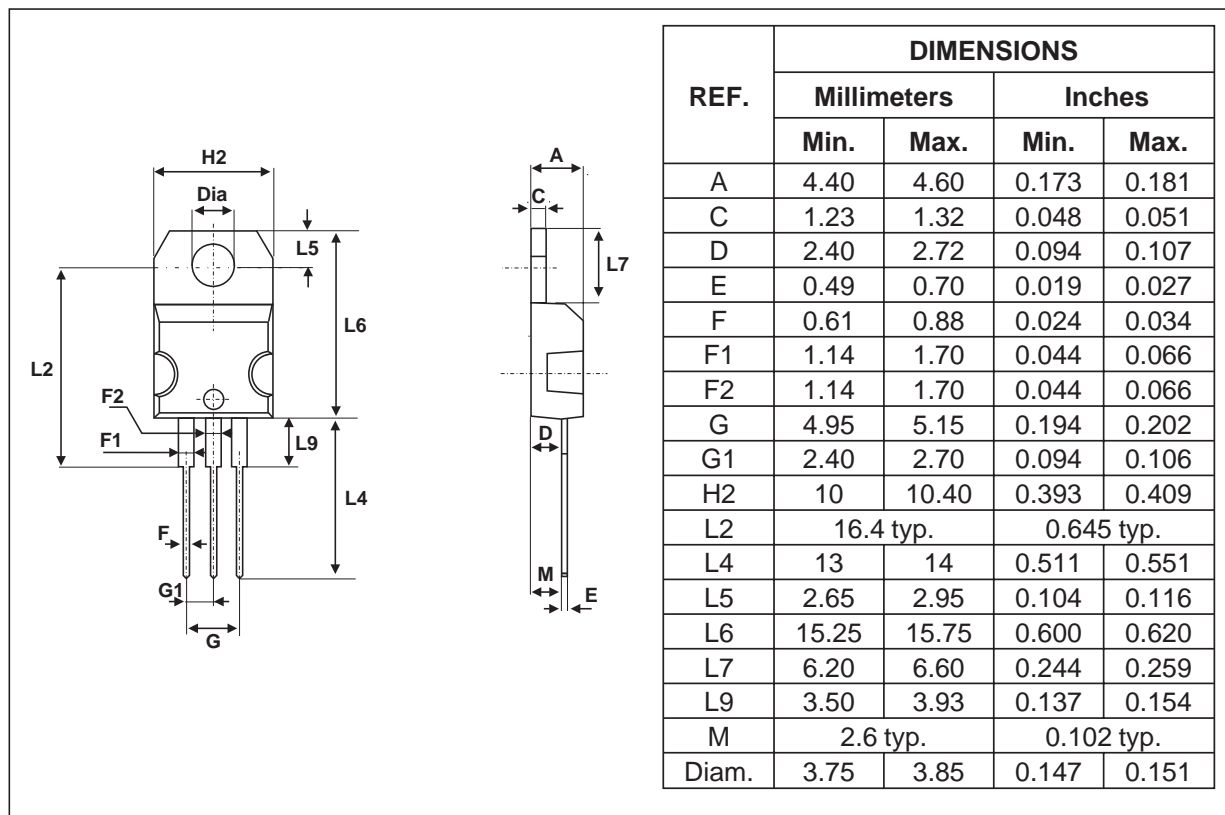

- COOLING METHOD : C
- RECOMMENDED TORQUE VALUE : 0.55 M.N
- MAXIMUM TORQUE VALUE : 0.70 M.N

Ordering type	Marking	Package	Weight	Base qty	Delivery mode
STPS4030CT	STPS4030CT	TO-220AB	2.2 g	50	Tube
STPS4030CG	STPS4030CG	D ² PAK	1.48 g	50	Tube
STPS4030CG-TR	STPS4030CG	D ² PAK	1.48 g	1000	Tape & reel
STPS4030CR	STPS4030CR	I ² PAK	1.49 g	50	Tube

- EPOXY MEETS UL94,V0

Information furnished is believed to be accurate and reliable. However, STMicroelectronics assumes no responsibility for the consequences of use of such information nor for any infringement of patents or other rights of third parties which may result from its use. No license is granted by implication or otherwise under any patent or patent rights of STMicroelectronics. Specifications mentioned in this publication are subject to change without notice. This publication supersedes and replaces all information previously supplied. STMicroelectronics products are not authorized for use as critical components in life support devices or systems without express written approval of STMicroelectronics.

The ST logo is a registered trademark of STMicroelectronics
 © 2003 STMicroelectronics - Printed in Italy - All rights reserved.
 STMicroelectronics GROUP OF COMPANIES
 Australia - Brazil - Canada - China - Finland - France - Germany
 Hong Kong - India - Israel - Italy - Japan - Malaysia - Malta - Morocco - Singapore
 Spain - Sweden - Switzerland - United Kingdom - United States.

<http://www.st.com>

Mouser Electronics

Authorized Distributor

Click to View Pricing, Inventory, Delivery & Lifecycle Information:

[STMicroelectronics:](#)

[STPS4030CT](#)