

ESDONCAN1, SESDONCAN1

CAN/CAN-FD Bus Protector

Low Capacitance ESD Protection Diode for CAN/CAN-FD Bus

The S/ESDONCAN1 has been designed to protect the CAN transceiver from ESD and other harmful transient voltage events. This device provides bidirectional protection for each data line with a single compact SOT-23 package, giving the system designer a low cost option for improving system reliability and meeting stringent EMI requirements.

Features

- 200 W Peak Power Dissipation per Line (8 x 20 μ sec Waveform)
- Diode Capacitance Matching
- Low Reverse Leakage Current (< 100 nA)
- Low Capacitance High-Speed FlexRay Data Rates
- IEC Compatibility:
 - IEC 61000-4-2 (ESD): Level 4
 - IEC 61000-4-4 (EFT): 50 A – 5/50 ns
 - IEC 61000-4-5 (Lighting) 3.0 A (8/20 μ s)
- ISO 7637-1, Nonrepetitive EMI Surge Pulse 2, 8.0 A (1 x 50 μ s)
- ISO 7637-3, Repetitive Electrical Fast Transient (EFT) EMI Surge Pulses, 50 A (5 x 50 ns)
- Flammability Rating UL 94 V-0
- S Prefix for Automotive and Other Applications Requiring Unique Site and Control Change Requirements; AEC-Q101 Qualified and PPAP Capable
- These are Pb-Free Devices

Typical Applications

- Industrial
 - ◆ Smart Distribution Systems (SDS)
 - ◆ DeviceNet
- Automotive
 - ◆ Controlled Area Network – CAN 2.1 / CAN FD
 - ◆ Low and High Speed CAN



ON Semiconductor®

www.onsemi.com

SOT-23 DUAL BIDIRECTIONAL VOLTAGE SUPPRESSOR 200 W PEAK POWER

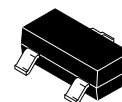

SOT-23
CASE 318
STYLE 27

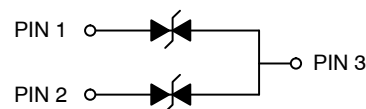

MARKING DIAGRAM

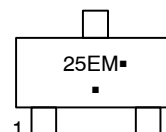

25E = Device Code
M = Date Code
▪ = Pb-Free Package

(Note: Microdot may be in either location)

ORDERING INFORMATION

See detailed ordering and shipping information in the package dimensions section on page 2 of this data sheet.

ESDONCAN1, SESDONCAN1

MAXIMUM RATINGS ($T_J = 25^\circ\text{C}$, unless otherwise specified)

Symbol	Rating	Value	Unit
PPK	Peak Power Dissipation, 8 x 20 μs Double Exponential Waveform (Note 1)	200	W
T_J	Operating Junction Temperature Range	-55 to 150	$^\circ\text{C}$
T_J	Storage Temperature Range	-55 to 150	$^\circ\text{C}$
T_L	Lead Solder Temperature (10 s)	260	$^\circ\text{C}$
ESD	Human Body Model (HBM) Machine Model (MM) IEC 61000-4-2 Specification (Contact)	8.0 400 23	kV V kV

Stresses exceeding those listed in the Maximum Ratings table may damage the device. If any of these limits are exceeded, device functionality should not be assumed, damage may occur and reliability may be affected.

1. Non-repetitive current pulse per Figure 1.

ELECTRICAL CHARACTERISTICS ($T_J = 25^\circ\text{C}$, unless otherwise specified)

Symbol	Parameter	Test Conditions	Min	Typ	Max	Unit
V_{RWM}	Reverse Working Voltage	(Note 2)	24	-	-	V
V_{BR}	Breakdown Voltage	$I_T = 1\text{ mA}$ (Note 3)	26.2	-	32	V
I_R	Reverse Leakage Current	$V_{RWM} = 24\text{ V}$	-	15	100	nA
V_C	Clamping Voltage	$I_{PP} = 1\text{ A}$ (8 x 20 μs Waveform) (Note 4)	-	33.4	36.6	V
V_C	Clamping Voltage	$I_{PP} = 3\text{ A}$ (8 x 20 μs Waveform) (Note 4)	-	44	50	V
I_{PP}	Maximum Peak Pulse Current	8 x 20 μs Waveform (Note 4)	-	-	3.0	A
C_J	Capacitance	$V_R = 0\text{ V}$, $f = 1\text{ MHz}$ (Line to GND)	-	-	10	pF
ΔC	Diode Capacitance Matching	$V_R = 0\text{ V}$, 5 MHz (Note 5)	-	0.26	2	%

Product parametric performance is indicated in the Electrical Characteristics for the listed test conditions, unless otherwise noted. Product performance may not be indicated by the Electrical Characteristics if operated under different conditions.

2. Surge protection devices are normally selected according to the working peak reverse voltage (V_{RWM}), which should be equal or greater than the DC or continuous peak operating voltage level.
3. V_{BR} is measured at pulse test current I_T .
4. Pulse waveform per Figure 1.
5. ΔC is the percentage difference between C_J of lines 1 and 2 measured according to the test conditions given in the electrical characteristics table.

ORDERING INFORMATION

Device	Package	Shipping [†]
ESDONCAN1LT1G	SOT-23 (Pb-Free)	3,000 / Tape & Reel
SESDONCAN1LT1G*	SOT-23 (Pb-Free)	3,000 / Tape & Reel
ESDONCAN1LT3G	SOT-23 (Pb-Free)	10,000 / Tape & Reel
SESDONCAN1LT3G*	SOT-23 (Pb-Free)	10,000 / Tape & Reel

[†]For information on tape and reel specifications, including part orientation and tape sizes, please refer to our Tape and Reel Packaging Specifications Brochure, BRD8011/D.

*S Prefix for Automotive and Other Applications Requiring Unique Site and Control Change Requirements; AEC-Q101 Qualified and PPAP Capable.

ESDONCAN1, SESDONCAN1

TYPICAL PERFORMANCE CURVES

($T_J = 25^\circ\text{C}$ unless otherwise noted)

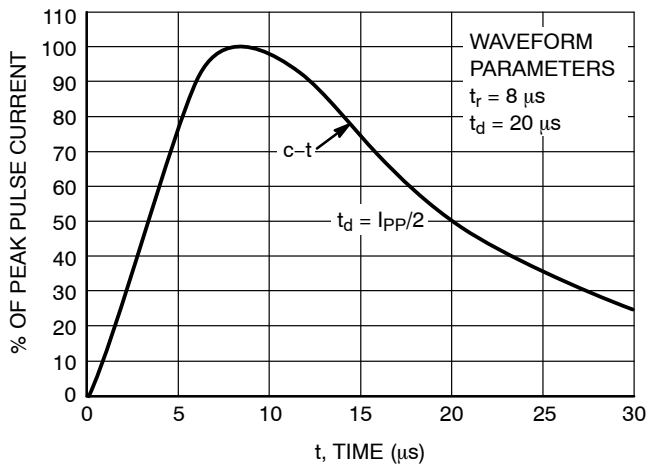

Figure 1. Pulse Waveform, $8 \times 20 \mu\text{s}$

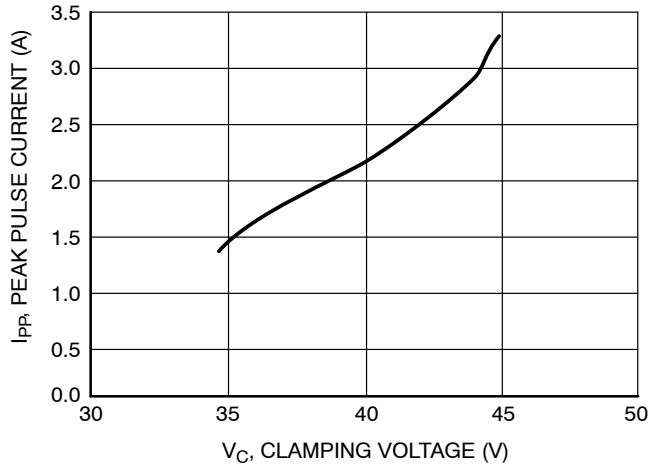

Figure 2. Clamping Voltage vs Peak Pulse Current

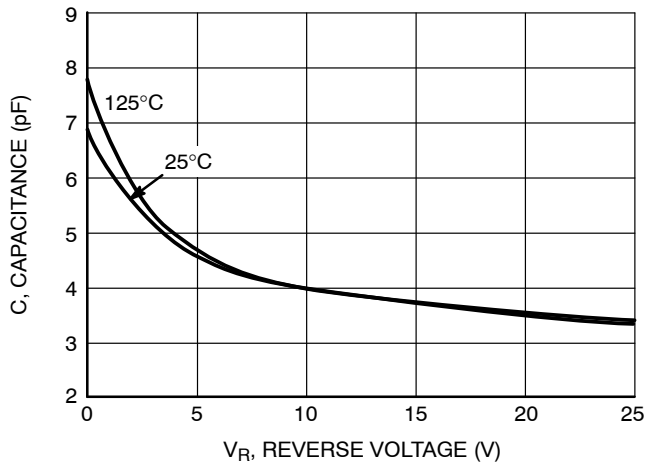

Figure 3. Typical Junction Capacitance vs Reverse Voltage

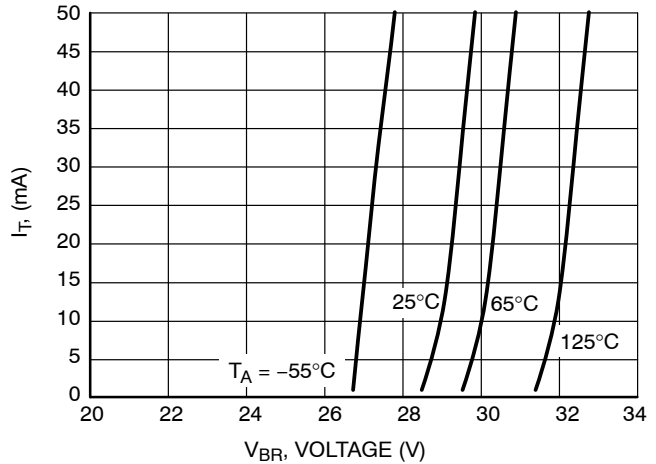

Figure 4. V_{BR} versus I_r Characteristics

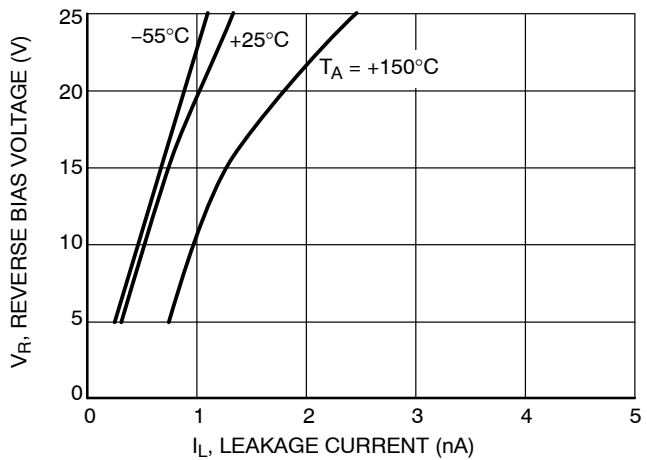

Figure 5. I_R versus Temperature Characteristics

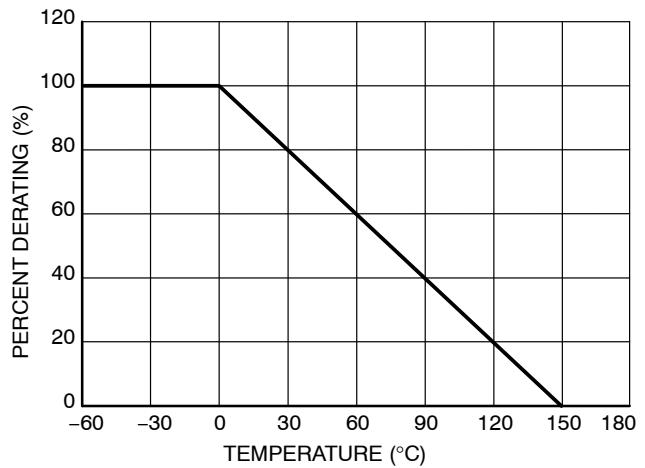

Figure 6. Temperature Power Dissipation Derating

ESDONCAN1, SESDONCAN1

APPLICATIONS

Background

The Controller Area Network (CAN) is a serial communication protocol designed for providing reliable high speed data transmission in harsh environments. Surge protection diodes provide a low cost solution to conducted and radiated Electromagnetic Interference (EMI) and Electrostatic Discharge (ESD) noise problems. The noise immunity level and reliability of CAN transceivers can be easily increased by adding external surge protection diodes to prevent transient voltage failures. The ESDONCAN1 provides a surge protection solution for CAN data

communication lines. The ESDONCAN1 is a low capacitance dual bidirectional surge protection device in a compact SOT-23 package especially suitable for CAN2.1 (CAN-FD). This device is based on Zener technology that optimizes the active area of a PN junction to provide robust protection against transient EMI surge voltage and ESD. The ESDONCAN1 has been tested to EMI and ESD levels that exceed the specifications of popular high speed CAN networks.

ESDONCAN1, SESDONCAN1

PACKAGE DIMENSIONS

SOT-23 (TO-236)
CASE 318-08
ISSUE AR

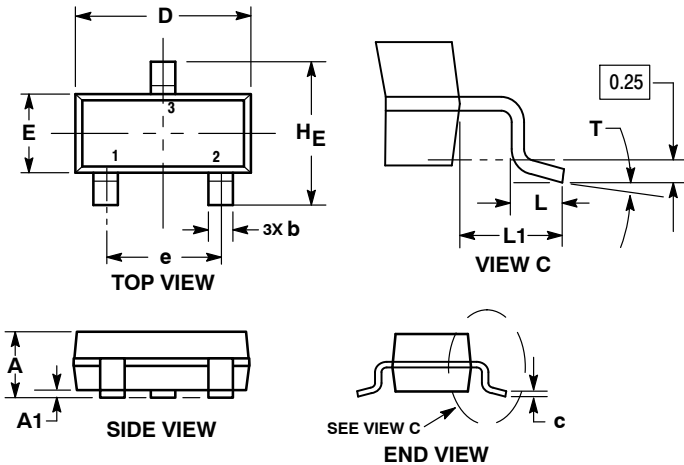

NOTES:

1. DIMENSIONING AND TOLERANCING PER ASME Y14.5M, 1994.
2. CONTROLLING DIMENSION: MILLIMETERS.
3. MAXIMUM LEAD THICKNESS INCLUDES LEAD FINISH. MINIMUM LEAD THICKNESS IS THE MINIMUM THICKNESS OF THE BASE MATERIAL.
4. DIMENSIONS D AND E DO NOT INCLUDE MOLD FLASH, PROTRUSIONS, OR GATE BURRS.

DIM	MILLIMETERS			INCHES		
	MIN	NOM	MAX	MIN	NOM	MAX
A	0.89	1.00	1.11	0.035	0.039	0.044
A1	0.01	0.06	0.10	0.000	0.002	0.004
b	0.37	0.44	0.50	0.015	0.017	0.020
c	0.08	0.14	0.20	0.003	0.006	0.008
D	2.80	2.90	3.04	0.110	0.114	0.120
E	1.20	1.30	1.40	0.047	0.051	0.055
e	1.78	1.90	2.04	0.070	0.075	0.080
L	0.30	0.43	0.55	0.012	0.017	0.022
L1	0.35	0.54	0.69	0.014	0.021	0.027
HE	2.10	2.40	2.64	0.083	0.094	0.104
T	0°	---	10°	0°	---	10°

STYLE 27:
PIN 1. CATHODE
PIN 2. CATHODE
PIN 3. CATHODE

RECOMMENDED SOLDERING FOOTPRINT*

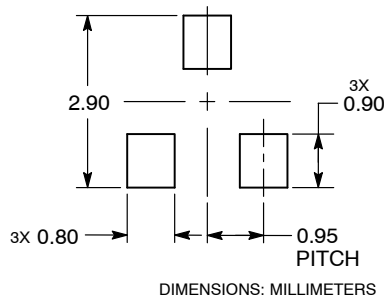

*For additional information on our Pb-Free strategy and soldering details, please download the ON Semiconductor Soldering and Mounting Techniques Reference Manual, SOLDERRM/D.

Honeywell and SDS are registered trademarks of Honeywell International Inc.
DeviceNet is a trademark of Rockwell Automation.

ON Semiconductor and are trademarks of Semiconductor Components Industries, LLC dba ON Semiconductor or its subsidiaries in the United States and/or other countries. ON Semiconductor owns the rights to a number of patents, trademarks, copyrights, trade secrets, and other intellectual property. A listing of ON Semiconductor's product/patent coverage may be accessed at www.onsemi.com/site/pdf/Patent-Marking.pdf. ON Semiconductor reserves the right to make changes without further notice to any products herein. ON Semiconductor makes no warranty, representation or guarantee regarding the suitability of its products for any particular purpose, nor does ON Semiconductor assume any liability arising out of the application or use of any product or circuit, and specifically disclaims any and all liability, including without limitation special, consequential or incidental damages. Buyer is responsible for its products and applications using ON Semiconductor products, including compliance with all laws, regulations and safety requirements or standards, regardless of any support or applications information provided by ON Semiconductor. "Typical" parameters which may be provided in ON Semiconductor data sheets and/or specifications can and do vary in different applications and actual performance may vary over time. All operating parameters, including "Typicals" must be validated for each customer application by customer's technical experts. ON Semiconductor does not convey any license under its patent rights nor the rights of others. ON Semiconductor products are not designed, intended, or authorized for use as a critical component in life support systems or any FDA Class 3 medical devices or medical devices with a same or similar classification in a foreign jurisdiction or any devices intended for implantation in the human body. Should Buyer purchase or use ON Semiconductor products for any such unintended or unauthorized application, Buyer shall indemnify and hold ON Semiconductor and its officers, employees, subsidiaries, affiliates, and distributors harmless against all claims, costs, damages, and expenses, and reasonable attorney fees arising out of, directly or indirectly, any claim of personal injury or death associated with such unintended or unauthorized use, even if such claim alleges that ON Semiconductor was negligent regarding the design or manufacture of the part. ON Semiconductor is an Equal Opportunity/Affirmative Action Employer. This literature is subject to all applicable copyright laws and is not for resale in any manner.

PUBLICATION ORDERING INFORMATION

LITERATURE FULFILLMENT:
Literature Distribution Center for ON Semiconductor
19521 E. 32nd Pkwy, Aurora, Colorado 80011 USA
Phone: 303-675-2175 or 800-344-3860 Toll Free USA/Canada
Fax: 303-675-2176 or 800-344-3867 Toll Free USA/Canada
Email: orderlit@onsemi.com

N. American Technical Support: 800-282-9855 Toll Free
USA/Canada
Europe, Middle East and Africa Technical Support:
Phone: 421 33 790 2910
Japan Customer Focus Center
Phone: 81-3-5817-1050

ON Semiconductor Website: www.onsemi.com
Order Literature: <http://www.onsemi.com/orderlit>

For additional information, please contact your local Sales Representative

Mouser Electronics

Authorized Distributor

Click to View Pricing, Inventory, Delivery & Lifecycle Information:

[ON Semiconductor:](#)

[SESDONCAN1LT1G](#) [ESDONCAN1LT1G](#) [ESDONCAN1LT3G](#)