

# Neutralizing Ion Python Hand Gun Operation and Maintenance



Made in America



Figure 1. Ion Python Hand Gun (Controller with Hose)

## Description

The Desco Ion Python Neutralizing Hand Gun is a ready-to-use unit designed for use in applications and areas where static can create manufacturing or handling problems. These units quickly and effectively neutralize bulk static charges and aid in controlling contamination by dislodging dust and debris attracted by static electricity. Airflow may be easily adjusted from a gentle stream to a powerful blast. These units are designed for use in applications and areas where ElectroStatic Attraction contamination create manufacturing or handling problems (Ref: ESD Handbook TR 20.20 paragraph 5.3.6.5.2.4 Point of Use Ionization). The Ion Python meets or exceeds the recommended technical requirements of ANSI/ESD S20.20 tested in accordance with ANSI/ESD S3.1.

Ionizers are useful in preventing electrostatic charge generation, ElectroStatic Discharge, ElectroStatic Attraction, as well as preventing equipment latch-up and safety related shock. ANSI/ESD S20.20 Paragraph 6.2.3.1 Protected Areas Requirement states: "Ionization or other charge mitigating techniques shall be used at the workstation to neutralize electrostatic fields on all process essential insulators if the electrostatic field is considered a threat." Ionization is used to neutralize charges on process necessary insulators and isolated semiconductors. Some examples of process necessary insulators are: the PC board itself, plastic test stands, plastic housing where a PCB may be mounted, as well as computer monitor screens and regular cleaning wipes. Examples of floating or isolated conductors are: loaded PCB mounted in a stand where the pins are not contacting the dissipative workstation. Ionization is not effective on items that have large capacitance, like people and carts; however, ionizers should be considered as a method for charge neutralization in cases where grounding cannot be achieved.

Air ionization can neutralize the static charge on insulated and isolated objects by producing separate charges in the molecules of the gases of the surrounding air. When an electrostatic charge is present on objects in the work environment, it will be neutralized by attracting opposite polarity charges from the ionized air. Note that ionization systems should not be used as a primary means of charge control on conductors or people. (Reference: IEC 61340-5-2:1 paragraph 5.2.9).

The Ion Python Neutralizing Hand Gun is NIST calibrated. They come equipped with universal IEC cord connectors.

**NOTE: These units are not recommended for continuous use.**  
**IONIZER SELECTION**

MODEL	STYLE	VOLTAGE AC	IEC CORD
<a href="#">19587</a>	Hand Gun	120	Yes
<a href="#">19588</a>	Hand Gun	220	No

ANSI/ESD S20.20 paragraph 6.1.1.2. ESD Control Program Plan Guidance states: "The Plan should include a listing of the specific type of ESD protective materials and equipment used in the Program." When selecting an ionizer life cycle costs should be considered including: equipment cost; installation cost; and operation and maintenance cost.

## Air Requirements

Always supply the Ion Python Hand Gun with filtered, dry noncombustible gases, such as compressed shop air or nitrogen. (If nitrogen is used, the tip will need to be replaced and the unit recalibrated. This **MUST** be done by the factory. Contact customer service at 909-627-8178). If the air is not dry, damage to the equipment may result and the warranty will be voided. Dirty air can introduce moisture and oil, contaminating the units' emitter assembly along with the materials to be cleaned or neutralized. Filters must therefore be used at all times upstream of the air nozzle. A water trap-type pre-filter should be used in conjunction with an oil coalescing-type filter. Also drain all moisture traps regularly to prevent moisture in the line. Several drainings per day may be necessary, especially in areas of high humidity.

The Neutralizing Ion Python Hand Gun may be operated over a range of 30 PSI to 100 PSI. The specific pressure needed will depend upon the application. Pressures exceeding 100 PSI are not recommended since these higher pressures are detrimental to effective ion production. An air pressure setting of 60 PSI is recommended. Use the needle valve located on the back of the controller to properly adjust the air flow.

## Air Supply Connection

Turn off air at regulator (or compressor). Insert the brass male connector (1/4" tubing to 1/8" pipe thread) into an available port on the regulator. If all ports are being used, a "T" or "+" may be added to create more ports. Connect the 1/4" tubing to the male connector on the needle valve on back side of the unit, following the instructions given below.

### To connect tubing or filter to quick connect fitting:

Cut end of plastic tubing square and clean. Push against the collar with thumbnail. While holding collar in, push tubing into the fitting until it bottoms out completely.

### To release tubing or filter from quick connect fitting:

Push against the collar with thumbnail. While holding collar in, push tubing inward slightly, then pull tubing out.

**IMPORTANT NOTE:** User should exercise caution when using any compressed air device.

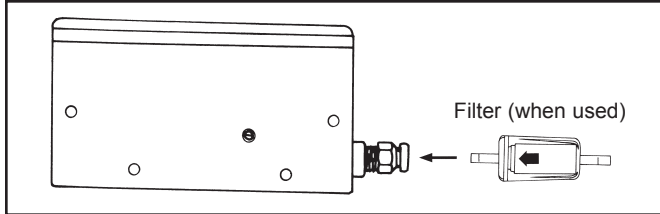

Figure 2. Connecting the optional filter. (Available as item #60355)

## Electrical Requirements

The Ion Python and Neutralizing Hand Gun must be connected to a properly grounded receptacle for the units to operate properly. It is recommended that the AC outlet be checked for proper wiring and grounding.

**Do not under any circumstances remove the ground pin from the plug of these units.**

**NOTE:** Grounding of these units is necessary not only to ensure that they operate properly, but to eliminate the possibility of an electrical shock.

## Operation

Turn on unit with switch on the front panel. The green light indicates that the air nozzle is ready for use. Point nozzle at object to be cleaned or neutralized.

For the Neutralizing Hand Gun, push button on the nozzle body to initiate the flow of air and neutralizing ions. Best results are normally obtained when holding the nozzle within 2 or 3 feet of the item being neutralized; hold the nozzle closer when required.

**NOTE:** Unit is not designed for continuous duty.

A needle valve is located on the back of the unit for fine adjustments to the air flow, or for shutting off the air to the nozzle. Airflow on the unit can be adjusted from a gentle blow to a strong blast, allowing for use in most applications. Do not obstruct the air jet with fingers or other objects. Do not force any object into the air jet hole; this action can easily damage the emitter pin and prevent the controller from producing the ionization necessary for neutralizing static charges.

The ion balance is affected by many factors, such as distance, air flow, humidity, and emitter contamination. Therefore, before using this device around components and assemblies which are highly sensitive to ESD, it is recommended that the user thoroughly evaluate the application prior to its use. Avoid sharply bending or crushing the black convoluted tubing under feet, rolling chairs or other furniture.

**IMPORTANT NOTE:** These air nozzles are not explosion proof. Do not use in environments where volatile materials are present.

Desco solid-state electronic equipment is compact and rugged but should be treated as sensitive electronic equipment. With proper installation and a continued preventive maintenance program you will ensure the proper performance of the unit.

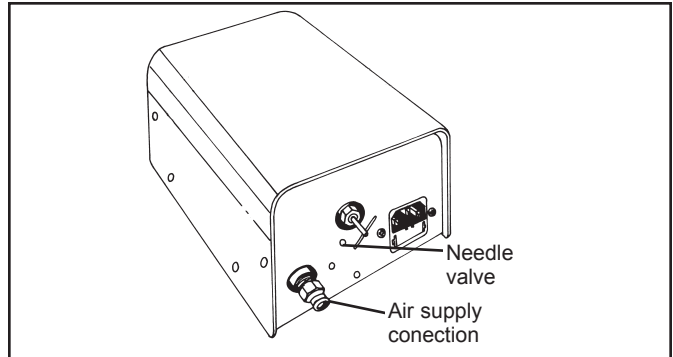

Figure 3. Airflow adjustment valve.

## Theory of Operation

The Ion Python and Neutralizing Hand gun employ high voltage AC to create a balanced ion field. AC systems utilize emitters that are switched rapidly between positive and negative high voltage, usually at the power line frequency (50/60 Hz). The emitter is located at the end of the nozzle. This emitter produces large amounts of positive and negative ions, which mix with the air supply and create a highly effective neutralizing field. Any material within this field will be neutralized rapidly. The air nozzles also eliminate contamination by dislodging dust and debris which is attracted to a material's surface by static charges. Once static charges are neutralized, dust particles and other forms of contamination are freed and carried away by the air stream. Desco ionizers meet the ANSI/ESD S20.20 minimum recommended technical requirement range of less than  $\pm 50$  volts voltage offset tested in accordance with ANSI EOS/ESD S3.1. Air Nozzle Ionizers provide  $\pm 20$  volt balance.

## Maintenance

"As with all ionizers, periodic maintenance will be needed to provide optimum performance." (Reference: IEC 61340-5-2:1 paragraph 5.2.9).

The frequency of monitoring ionizers really depends on how and where they are used. Since the majority of them use a fan to transport the ions to the working area, the cleanliness of the air directly affects their performance over time and how often the emitters should be cleaned.

EIA-625 recommends checking ionizers every 6 months, but this may not be suitable for many programs particularly since an out-of-balance may exist for months before it is checked again. ANSI/ESD S20.20 paragraph 6.1.3.1 Compliance Verification Plan Requirement states: "Test equipment shall be selected to make measurements of appropriate properties of the technical requirements that are incorporated into the ESD program plan." And paragraph 6.1.3.2. Compliance Verification Plan Guidance states: "In addition to internal audits, external audits (Organization and supplier of ESDS items) should be performed to ensure compliance with planned requirements. Verifications should include routine checks of the Technical Requirements in the Plan. The frequency of verification checks should be based on the control item usage, its durability and associated risk of failure."

Under normal conditions, the ionizer will attract dirt and dust (especially on the emitter electrodes). To maintain optimum performance, cleaning **must** be performed on a regular basis. The electrodes should be cleaned at least every six months. However, more frequent cleaning may be required if used in environments with more contaminants.

These units need very little maintenance. In order to maintain the optimum performance of your unit, the following maintenance procedures must be performed on a regular basis.

Make sure that the air supply is clean and free of contamination and moisture. Drain compressor tank and filters periodically.

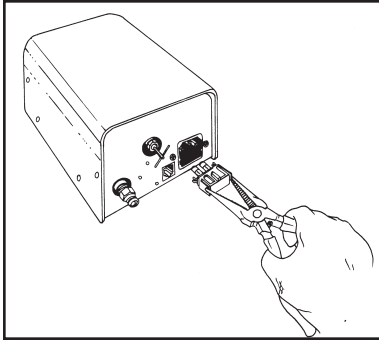

The filters may require draining several times daily, depending on your compressed air system.

The fuse may be replaced by removing the power cord at the back of the unit and opening the fuse box at the IEC receptacle. The controller uses a 1 amp fast acting fuse. **For safety, do not use other ratings.**

Figure 4. Replacing the fuse.

Do not attempt to perform any repairs or adjustments on your Desco equipment except for those covered in the operation manual. Self-made repairs could create a hazard and will void the warranty.

### Replacing the Air Nozzle Assembly

The air nozzle and hose assembly is designed to be removed or replaced by the user in the event of damage or wear. To replace the assembly, simply unscrew the collar at the base of the hose and gently disconnect the connector from the receptacle.

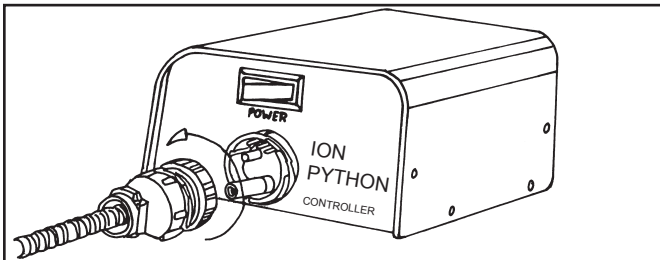

Figure 5. Replacing air nozzle assembly

To replace the nozzle assembly simply repeat the process in reverse.

NOTE: Make sure the fittings inside the connector are properly aligned with their receptacles before tightening the threaded collar.

### Replacing the Air Filter of the Ion Python

Periodic replacement of the air filter is recommended for optimum performance of the ionizer. Compress outer sleeving away from the filter housing. Examine the filter for any evidence of contamination. The filter will turn red if there is any oil contamination. If there has been moisture build-up, there will be a change in

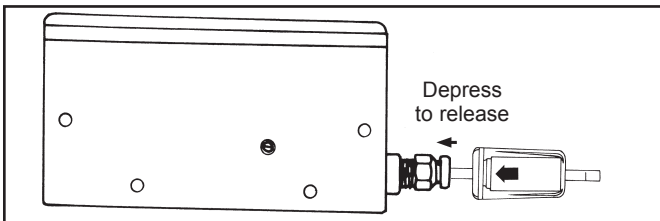

Figure 6. Air filter replacement.

air volume or a brownish color to the filter. If either of these conditions exist, you should replace the filter by unsnapping connectors. Depress air line connectors allowing removal of filter. The filter replacement is sold as Desco Item #60355 (two filters to a package). Be sure to observe the flow direction on filter when installing a replacement.

### Installation of the Controller and Ion Python Attachment

The mounting slots on the bottom of the controller allow for easy mounting of the base. Install screws either on a wall or bench. Using the mounting slots, place controller on the screws for secure mounting of the unit. Mounting the controller underneath a bench or on a wall saves valuable bench space. After mounting the unit, a locking screw is provided on the back of the unit to prevent accidental removal.

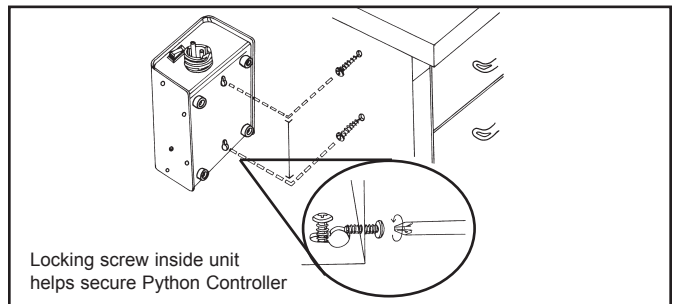

Figure 7. Installing controller to bench.

### Neutralization Efficiency (Decay Time)

The comparative neutralization efficiency of ionizers is determined by a standard test published by the ESD Association Standard 3.1. The decay rates measured using this standard are shown in the chart below. This performance was measured with the air nozzle at a distance of 6" from the charged plate and utilizing an air pressure of 30 PSIG.

#### Decay Rate per EOS/ESD S-3.1

Test Pressure	Decay Rate
30 PSI	2 seconds

#### Charge Decay Time Constants

- Notes:
- 1) Decay times are from 1,000 volts to 100 volts.
  - 2) The air nozzle's air stream is perpendicular to the charged plate.

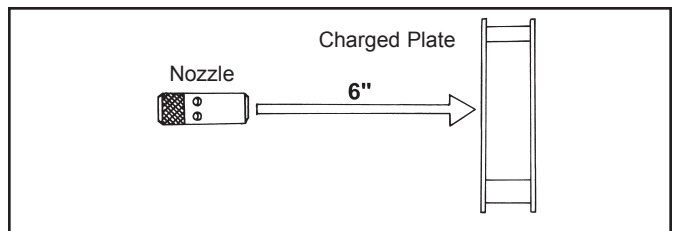

Figure 9. EOS/ESD S-3.1 decay time test set up.

## Testing and Calibration

Test using a version of EOS/ESD STM3.1. Observe and record offset voltage (float voltage) in voltage, measure of discharge time for +1000volts to +100volts and -1000volts to -100volts in seconds.

### Equipment and tools used:

- Charged Plate Monitor (CPM)
- Medium sizes insulative flat head screw driver

### Set-up:

1. Refer to EOS/ESD STM3.1, 6.4 Compresses gas ionizers - guns and nozzles. Test should be performed on static dissipative worksurface. Testing technician and worksurface needs to be properly grounded.
2. Refer to figure 14 - Test location for compressed gas - Guns or nozzles on page 13. CPM needs to be 6" from the center of the CPM plate to worksurface. Tip of air nozzle needs to be at 6" away from surface of CPM plate.

### Testing:

Lab environment should be at 75°F at +/-5°F, relative humidity at 45% at +/-5% RH. Observe offset voltage for no less than 10sec before recording.

	MFG Specifications	Recorded Values
Offset voltage (floating voltage) in voltage	+/-25 volts	
Discharge time, +1000volts to +100volts in seconds	2 sec or less	
Discharge time, -1000volts to -100volts in seconds	2 sec or less	

## Adjustment

Adjustments to the offset voltage could be made by using an insulative flat head screw. Balancing pot is location on the side of controller, where the white plastic cap is covering it.

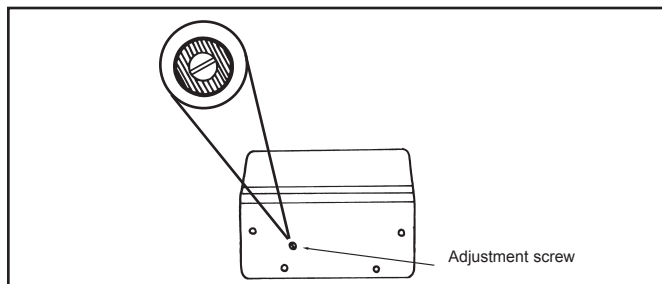

Figure 10. Balance Adjustment.

## Specifications

Input Voltage:	120 VAC, 50/60 Hz 220 VAC, 50/60 Hz
Amperage standby:	<50 milliamps
Amperage in use:	<400 milliamps
Fuse:	2ea 1 amp, 5 x 20mm, fast acting
Power Usage:	2.5 watts on, 25 watts in use
Power Cord:	Cord set with IEC connector Not included
Air Gun:	Two-piece molded ABS
Hose Length:	7 feet
Control Box:	5 1/8"H x 6 3/8"W x 7 1/8"L
Weight:	11 pounds
Air Usage:	3.5 CFM @ 30 PSI
Recommended PSI:	30 PSI to 100 PSI
Air fittings:	1/4" OD tubing with 1/8" NPT with adjustable needle valve.

## Health

There are no known health risks associated with our devices. The emitters work at about 4-6 kV and can create ozone, but there have been no significant measurement of ozone from our emitter sets, as all our existing units test well below the OSHA limit of 0.05 ppm ozone. For additional safety information, see "Dispelling an Old Myth" written by William Metz of Hewlett-Packard published in Evaluation Engineering magazine, September 2001.

- Indoor use
- Altitude up to 2000m
- Temperature 5°C to 40°C
- Maximum relative humidity 80% for temperatures up to 31°C decreasing linearly to 50% relative humidity at 40°C
- Mains supply voltage fluctuations up to ±10% of the nominal voltage
- Transient overvoltages typically present on the mains supply
- Applicable rated pollution degree is 2
- Degree of ingress protection is IP10

## Limited Warranty

Desco expressly warrants that for a period of one (1) year from the date of purchase, Desco ionizers will be free of defects in material (parts) and workmanship (labor). Within the warranty period, a unit will be tested, repaired or replaced at Desco's option, free of charge. Call Customer Service at 909-627-8178 (Chino, CA) or 781-821-8370 (Canton, MA) for Return Material Authorization (RMA) and proper shipping instructions and address. You should include a copy of your original packing slip, invoice, or other proof of purchase date. Any unit under warranty should be shipped prepaid to the Desco factory. Warranty repairs will take approximately two weeks.

If your unit is out of warranty, Desco will quote repair charges necessary to bring your unit to factory standards. Call Customer Service at 909-627-8178 (Chino, CA) or 781-821-8370 (Canton, MA) for a Return Material Authorization (RMA) and proper shipping instructions and address.

## Warranty Exclusions

THE FOREGOING EXPRESS WARRANTY IS MADE IN LIEU OF ALL OTHER PRODUCT WARRANTIES, EXPRESSED AND IMPLIED, INCLUDING MERCHANTABILITY AND FITNESS FOR A PARTICULAR PURPOSE WHICH ARE SPECIFICALLY DISCLAIMED. The express warranty will not apply to defects or damage due to accidents, neglect, misuse, alterations, operator error, or failure to properly maintain, clean or repair products.

## Limit of Liability

Electronic ionizers use high voltage corona discharge and should not be used in or near flammable or explosive environments. In no event will Desco or any seller be responsible or liable for any injury, loss or damage, direct or consequential, arising out of the use of or the inability to use the product. Before using, users shall determine the suitability of the product for their intended use, and users assume all risk and liability whatsoever in connection therewith.

# Mouser Electronics

Authorized Distributor

Click to View Pricing, Inventory, Delivery & Lifecycle Information:

[Desco:](#)

[19587](#)