

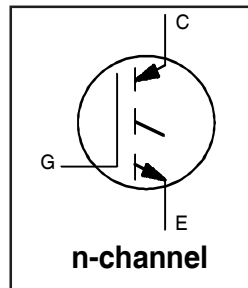
# IRG4PH50S-EPbF

INSULATED GATE BIPOLAR TRANSISTOR

Standard Speed IGBT

## Features

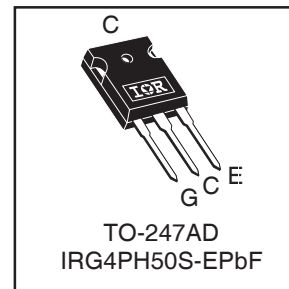
- Standard: Optimized for minimum saturation voltage and low operating frequencies (< 1kHz)
- Generation 4 IGBT design provides tighter parameter distribution and higher efficiency than Generation 3
- Industry standard TO-247AC package
- Lead-Free



$V_{CES} = 1200V$
$V_{CE(on)} \text{ typ.} = 1.47V$
@ $V_{GE} = 15V, I_C = 33A$

## Benefits

- Generation 4 IGBT's offer highest efficiency available
- IGBT's optimized for specified application conditions
- Designed to be a "drop-in" replacement for equivalent industry-standard Generation 3 IR IGBT's



## Absolute Maximum Ratings

	Parameter	Max.	Units
$V_{CES}$	Collector-to-Emitter Voltage	1200	V
$I_C @ T_C = 25^\circ C$	Continuous Collector Current	57	A
$I_C @ T_C = 100^\circ C$	Continuous Collector Current	33	
$I_{CM}$	Pulsed Collector Current <sup>①</sup>	114	
$I_{LM}$	Clamped Inductive Load Current <sup>②</sup>	114	
$V_{GE}$	Gate-to-Emitter Voltage	$\pm 20$	V
	Transient Gate-to-Emitter Voltage	$\pm 30$	
$E_{ARV}$	Reverse Voltage Avalanche Energy <sup>③</sup>	270	mJ
$P_D @ T_C = 25^\circ$	Maximum Power Dissipation	200	W
$P_D @ T_C = 100^\circ$	Maximum Power Dissipation	80	
$T_J$	Operating Junction and Storage Temperature Range	-55 to + 150	$^\circ C$
$T_{STG}$			
	Soldering Temperature, for 10 sec.	300 (0.063 in. (1.6mm) from case)	
	Mounting Torque, 6-32 or M3 Screw.	10 lbf·in (1.1 N·m)	

## Thermal Resistance

	Parameter	Min.	Typ.	Max.	Units
$R_{\theta JC}$	Junction-to-Case	—	—	0.64	$^\circ C/W$
$R_{\theta CS}$	Case-to-Sink, Flat, Greased Surface	—	0.24	—	
$R_{\theta JA}$	Junction-to-Ambient, typical socket mount	—	—	40	
Wt	Weight	—	6.0(0.21)	—	g (oz)

## Electrical Characteristics @ $T_J = 25^\circ\text{C}$ (unless otherwise specified)

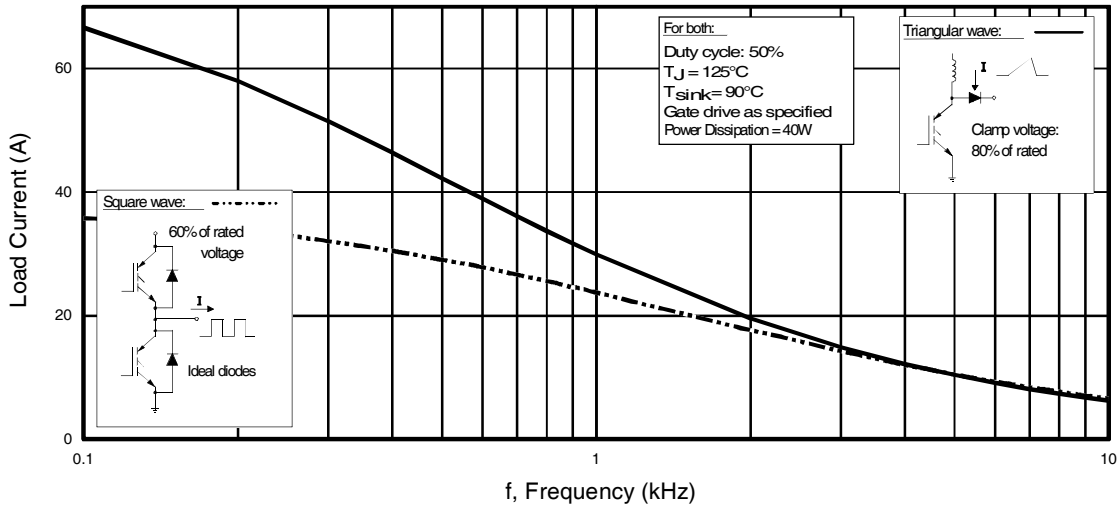
	Parameter	Min.	Typ.	Max.	Units	Conditions
$V_{(BR)CES}$	Collector-to-Emitter Breakdown Voltage	1200	—	—	V	$V_{GE} = 0V, I_C = 250\mu A$
$V_{(BR)ECS}$	Emitter-to-Collector Breakdown Voltage ④	18	—	—	V	$V_{GE} = 0V, I_C = 1.0 A$
$\Delta V_{(BR)CES}/\Delta T_J$	Temperature Coeff. of Breakdown Voltage	—	1.22	—	V/°C	$V_{GE} = 0V, I_C = 2.0 mA$
$V_{CE(ON)}$	Collector-to-Emitter Saturation Voltage	—	1.47	1.7	V	$I_C = 33A, V_{GE} = 15V$ $I_C = 57A$ $I_C = 33A, T_J = 150^\circ C$ See Fig.2, 5
		—	1.75	—		
		—	1.55	—		
$V_{GE(th)}$	Gate Threshold Voltage	3.0	—	6.0		$V_{CE} = V_{GE}, I_C = 250\mu A$
$DV_{GE(th)}/DT_J$	Temperature Coeff. of Threshold Voltage	—	-11	—	mV/°C	$V_{CE} = V_{GE}, I_C = 250\mu A$
$g_{fe}$	Forward Transconductance ⑤	27	40	—	S	$V_{CE} = 100V, I_C = 33A$
$I_{CES}$	Zero Gate Voltage Collector Current	—	—	250	$\mu A$	$V_{GE} = 0V, V_{CE} = 1200V$
		—	—	2.0		$V_{GE} = 0V, V_{CE} = 10V, T_J = 25^\circ C$
		—	—	1000		$V_{GE} = 0V, V_{CE} = 1200V, T_J = 150^\circ C$
$I_{GES}$	Gate-to-Emitter Leakage Current	—	—	$\pm 100$	nA	$V_{GE} = \pm 20V$

## Switching Characteristics @ $T_J = 25^\circ\text{C}$ (unless otherwise specified)

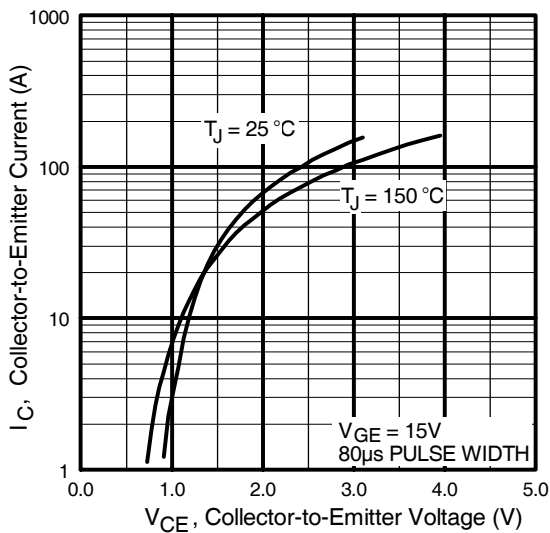
	Parameter	Min.	Typ.	Max.	Units	Conditions
$Q_g$	Total Gate Charge (turn-on)	—	167	251	nC	$I_C = 33A$ $V_{CC} = 400V$ $V_{GE} = 15V$ See Fig. 8
$Q_{ge}$	Gate - Emitter Charge (turn-on)	—	25	38		
$Q_{gc}$	Gate - Collector Charge (turn-on)	—	55	83		
$t_{d(on)}$	Turn-On Delay Time	—	32	—	ns	$T_J = 25^\circ C$ $I_C = 33A, V_{CC} = 960V$ $V_{GE} = 15V, R_G = 5.0\Omega$ Energy losses include "tail" See Fig. 9, 10, 14
$t_r$	Rise Time	—	29	—		
$t_{d(off)}$	Turn-Off Delay Time	—	845	1268		
$t_f$	Fall Time	—	425	638		
$E_{on}$	Turn-On Switching Loss	—	1.80	—	mJ	See Fig. 9, 10, 14
$E_{off}$	Turn-Off Switching Loss	—	19.6	—		
$E_{ts}$	Total Switching Loss	—	21.4	44		
$t_{d(on)}$	Turn-On Delay Time	—	32	—	ns	$T_J = 150^\circ C,$ $I_C = 33A, V_{CC} = 960V$ $V_{GE} = 15V, R_G = 5.0\Omega$ Energy losses include "tail" See Fig. 10,11,14
$t_r$	Rise Time	—	30	—		
$t_{d(off)}$	Turn-Off Delay Time	—	1170	—		
$t_f$	Fall Time	—	1000	—		
$E_{ts}$	Total Switching Loss	—	37	—	mJ	See Fig. 10,11,14
$L_E$	Internal Emitter Inductance	—	13	—	nH	Measured 5mm from package
$C_{ies}$	Input Capacitance	—	3600	—	pF	$V_{GE} = 0V$ $V_{CC} = 30V$ $f = 1.0MHz$ See Fig. 7
$C_{oes}$	Output Capacitance	—	160	—		
$C_{res}$	Reverse Transfer Capacitance	—	30	—		

### Notes:

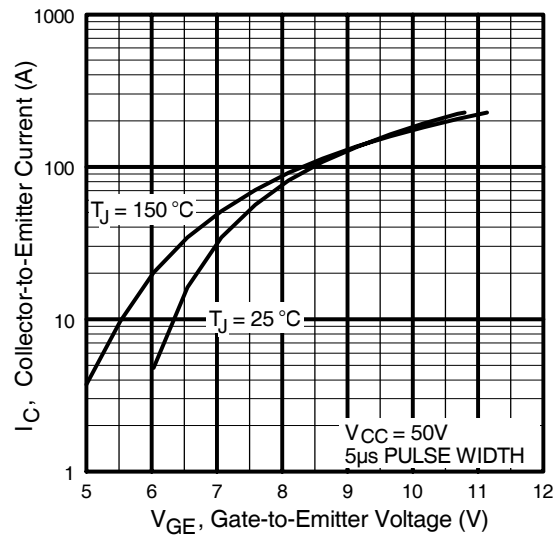
- ① Repetitive rating;  $V_{GE} = 20V$ , pulse width limited by max. junction temperature. ( See fig. 13b )
- ②  $V_{CC} = 80\%(V_{CES}), V_{GE} = 20V, L = 10\mu H, R_G = 5.0\Omega,$  (See fig. 13a)
- ③ Repetitive rating; pulse width limited by maximum junction temperature.
- ④ Pulse width  $\leq 80\mu s$ ; duty factor  $\leq 0.1\%$ .
- ⑤ Pulse width  $5.0\mu s$ , single shot.



**Fig. 1 - Typical Load Current vs. Frequency**  
(Load Current =  $I_{\text{RMS}}$  of fundamental)



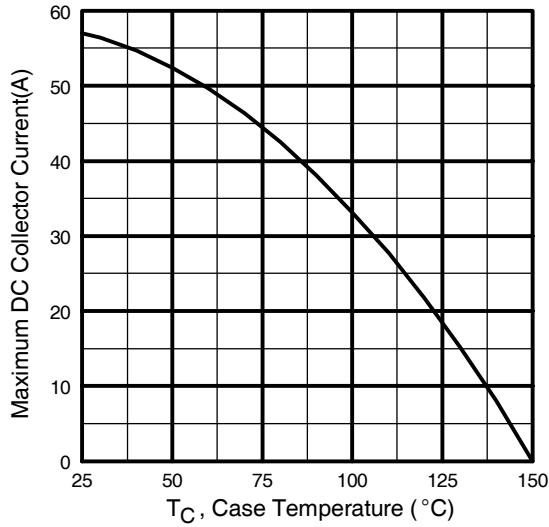
**Fig. 2 - Typical Output Characteristics**



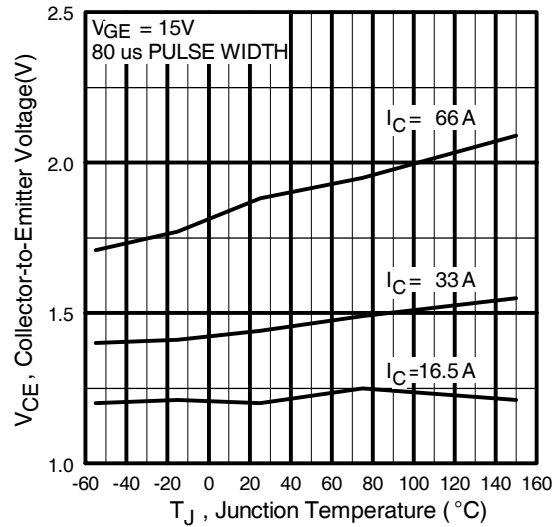
**Fig. 3 - Typical Transfer Characteristics**

# IRG4PH50S-EPbF

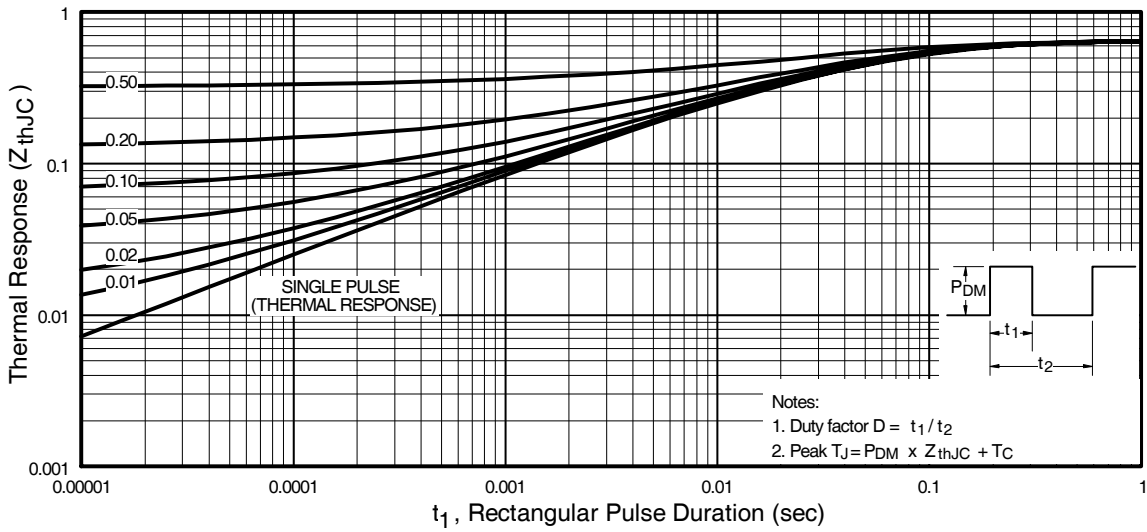
International  
**IR** Rectifier



**Fig. 4** - Maximum Collector Current vs. Case Temperature

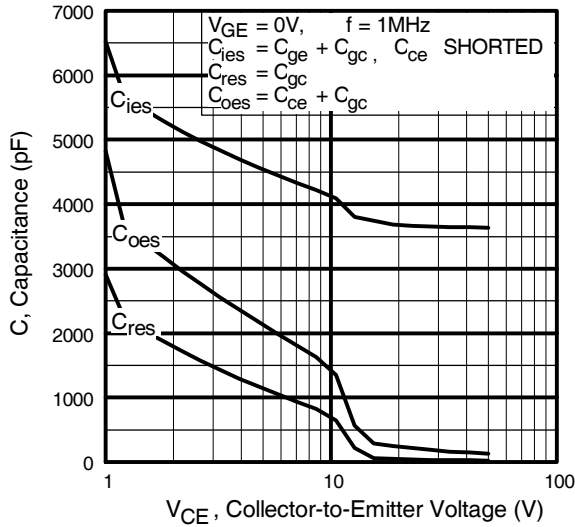


**Fig. 5** - Typical Collector-to-Emitter Voltage vs. Junction Temperature

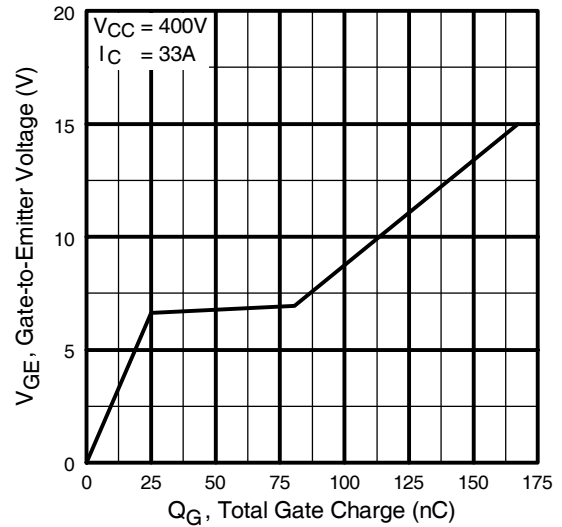


**Fig. 6** - Maximum Effective Transient Thermal Impedance, Junction-to-Case

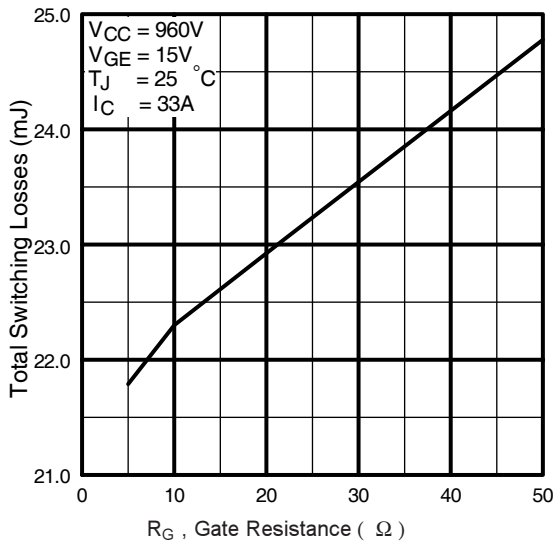
# IRG4PH50S-EPbF



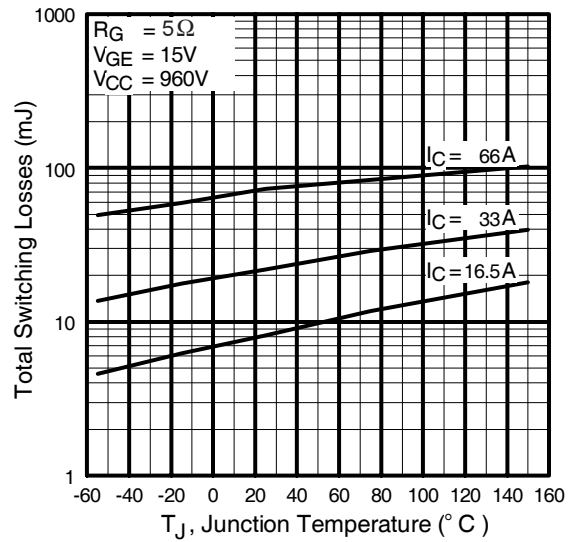
**Fig. 7** - Typical Capacitance vs. Collector-to-Emitter Voltage



**Fig. 8** - Typical Gate Charge vs. Gate-to-Emitter Voltage



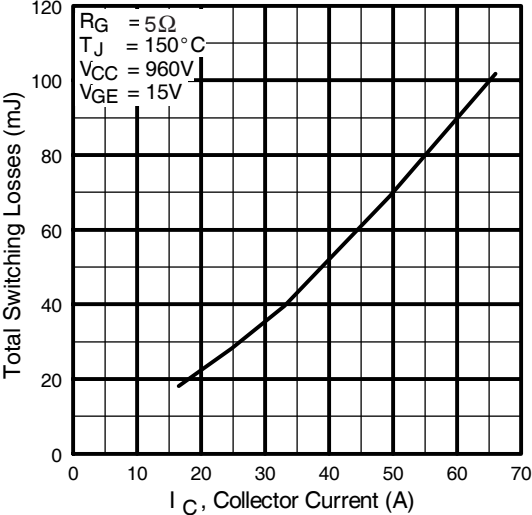
**Fig. 9** - Typical Switching Losses vs. Gate Resistance



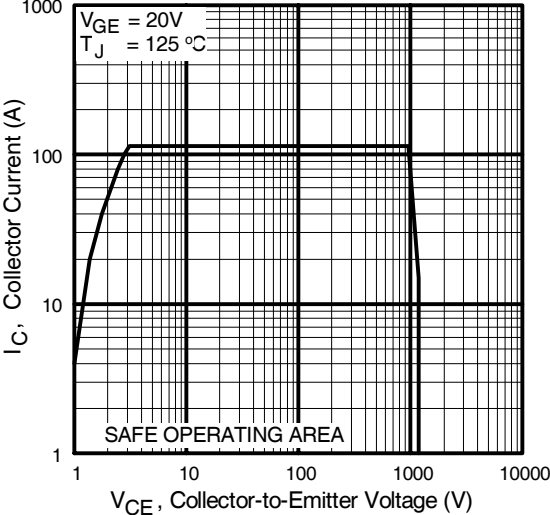
**Fig. 10** - Typical Switching Losses vs. Junction Temperature

# IRG4PH50S-EPbF

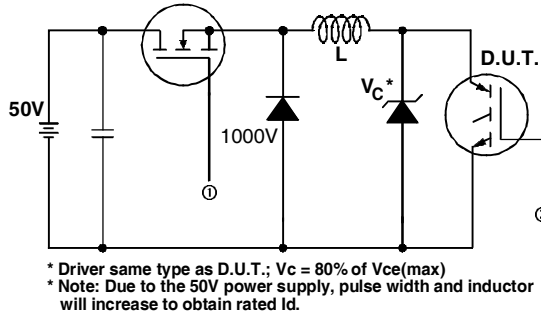
International  
**IR** Rectifier



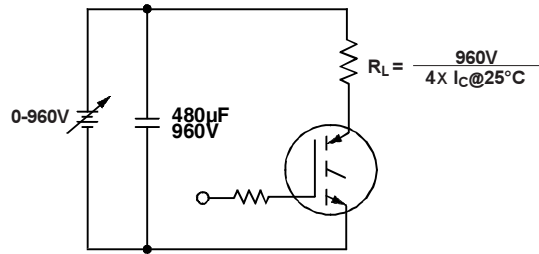
**Fig. 11** - Typical Switching Losses vs. Collector-to-Emitter Current



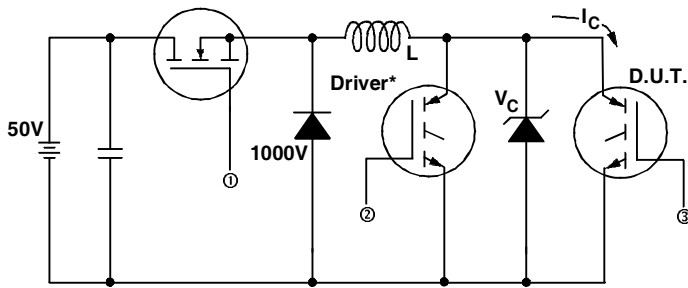
**Fig. 12** - Reverse Bias SOA



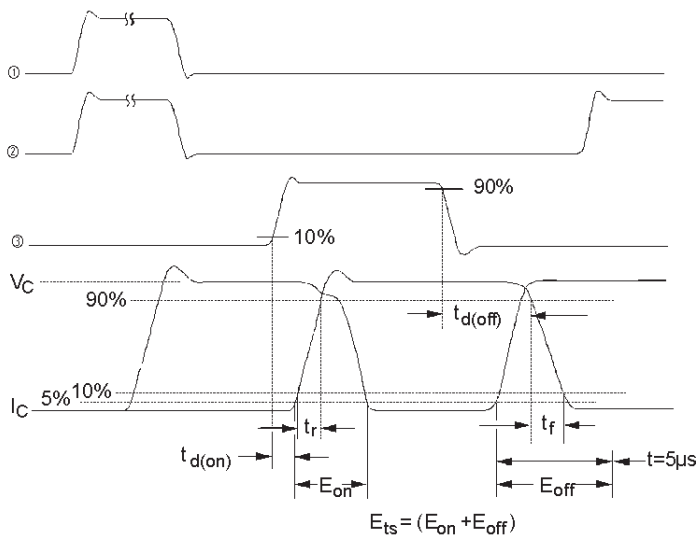
**Fig. 13a** - Clamped Inductive Load Test Circuit



**Fig. 13b** - Pulsed Collector Current Test Circuit



**Fig. 14a** - Switching Loss Test Circuit

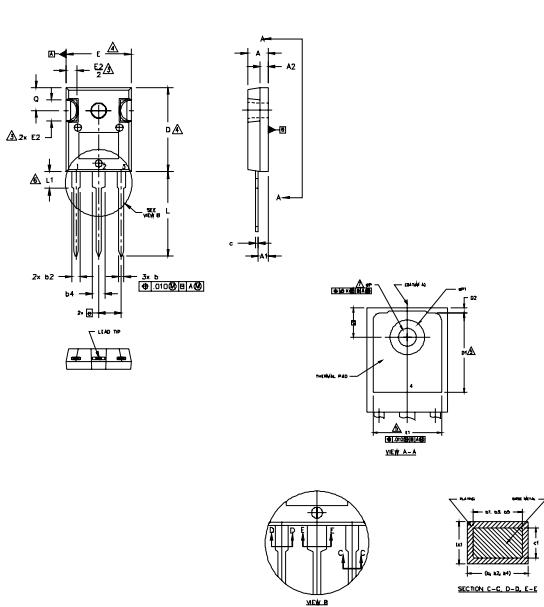


**Fig. 14b** - Switching Loss Waveforms

# IRG4PH50S-EPbF

International  
**IR** Rectifier

TO-247AD Package Outline (Dimensions are shown in millimeters (inches))



**NOTES:**

1. DIMENSIONING AND TOLERANCING AS PER ASME Y14.5M 1994.
2. DIMENSIONS ARE SHOWN IN INCHES.
3. CONTOUR OF SLOT OPTIONAL.
4. DIMENSION D & E DO NOT INCLUDE MOLD FLASH. MOLD FLASH SHALL NOT EXCEED .005" (0.127) PER SIDE. THESE DIMENSIONS ARE MEASURED AT THE OUTERMOST EXTREMES OF THE PLASTIC BODY.
5. THERMAL PAD CONTOUR OPTIONAL WITHIN DIMENSIONS D1 & E1.
6. LEAD FINISH UNCONTROLLED IN L1.
7.  $\phi P$  TO HAVE A MAXIMUM DRAFT ANGLE OF 1.5° TO THE TOP OF THE PART WITH A MAXIMUM HOLE DIAMETER OF .154 INCH.
8. OUTLINE CONFORMS TO JEDEC OUTLINE TO-247AD.

SYMBOL	DIMENSIONS				NOTES
	INCHES		MILLIMETERS		
	MIN.	MAX.	MIN.	MAX.	
A	.183	.209	4.65	5.31	
A1	.087	.102	2.21	2.59	
A2	.059	.098	1.50	2.49	
b	.039	.055	0.99	1.40	
b1	.039	.053	0.99	1.35	
b2	.065	.094	1.65	2.39	
b3	.065	.092	1.65	2.34	
b4	.102	.135	2.59	3.43	
b5	.102	.133	2.59	3.38	
c	.015	.035	0.38	0.89	
c1	.015	.033	0.38	0.84	
D	.776	.815	19.71	20.70	4
D1	.515	-	13.08	-	5
D2	.020	.053	0.51	1.35	
E	.602	.625	15.29	15.87	4
E1	.530	-	13.46	-	
E2	.178	.216	4.52	5.49	
e	.215 BSC		5.46 BSC		
ek	.010		0.25		
L	.780	.827	19.57	21.00	
L1	.146	.169	3.71	4.29	
$\phi P$	.140	.144	3.56	3.66	
$\phi P1$	-	.291	-	7.39	
Q	.209	.224	5.31	5.69	
S	.217 BSC		5.51 BSC		

**LEAD ASSIGNMENTS**

**HEXFET**

- 1.- GATE
- 2.- DRAIN
- 3.- SOURCE
- 4.- DRAIN

**IGBTs, CoPACK**

- 1.- GATE
- 2.- COLLECTOR
- 3.- EMITTER
- 4.- COLLECTOR

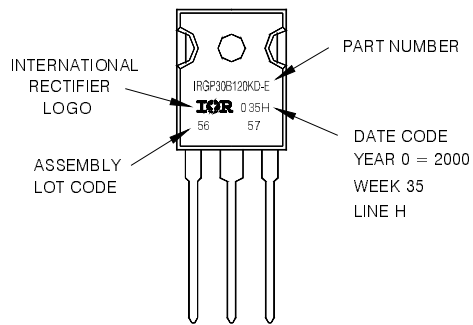
**DIODES**

- 1.- ANODE/OPEN
- 2.- CATHODE
- 3.- ANODE

## TO-247AD Part Marking Information

EXAMPLE: THIS IS AN IRGP30B120KD-E  
WITH ASSEMBLY  
LOT CODE 5657  
ASSEMBLED ON WW 35, 2000  
IN THE ASSEMBLY LINE 'H'

Note: 'P' in assembly line position  
indicates 'Lead-Free'



TO-247AD package is not recommended for Surface Mount Application.

Note: For the most current drawing please refer to IR website at: <http://www.irf.com/package/>

Data and specifications subject to change without notice.

International  
**IR** Rectifier

IR WORLD HEADQUARTERS: 233 Kansas St., El Segundo, California 90245, USA Tel: (310) 252-7105  
TAC Fax: (310) 252-7903

Visit us at [www.irf.com](http://www.irf.com) for sales contact information.02/2009

[www.irf.com](http://www.irf.com)