

LOW DROPOUT VOLTAGE REGULATOR WITH ON/OFF CONTROL

■ GENERAL DESCRIPTION

The NJM2386/88 is a general purpose low dropout voltage regulators with ON/OFF control.

The output current is up to 1.0A and dropout voltage is 0.2V typical at 500mA load.

It features high maximum input voltage of 35V for a wide application range including TV, home appliances and power modules.

■ PACKAGE OUTLINE

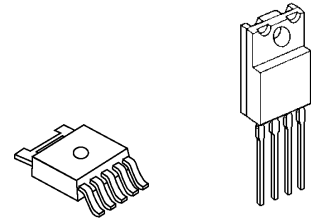

NJM2386DL3

NJM2388F

■ FEATURES

- High Maximum Input Voltage Up to 35V
- Low Dropout Voltage 0.2V typ. at $I_o=0.5A$
- Output Current $I_o(\text{max.})=1.0A$
- ON/OFF Control (Active High)
- Internal Short Circuit Current Limit
- Internal Overvoltage Protection
- Internal Thermal Overload Protection
- Bipolar Technology
- Package Outline TO-252-5(NJM2386), TO-220F-4(NJM2388)

■ PIN CONFIGURATION

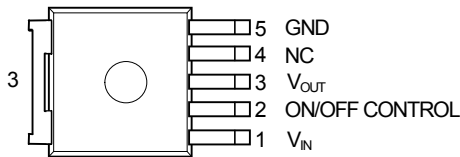

NJM2386DL3

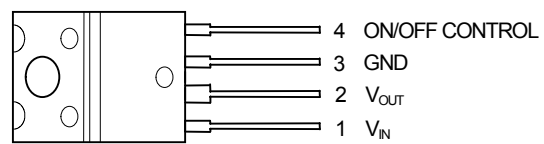

NJM2388F

■ BLOCK DIAGRAM

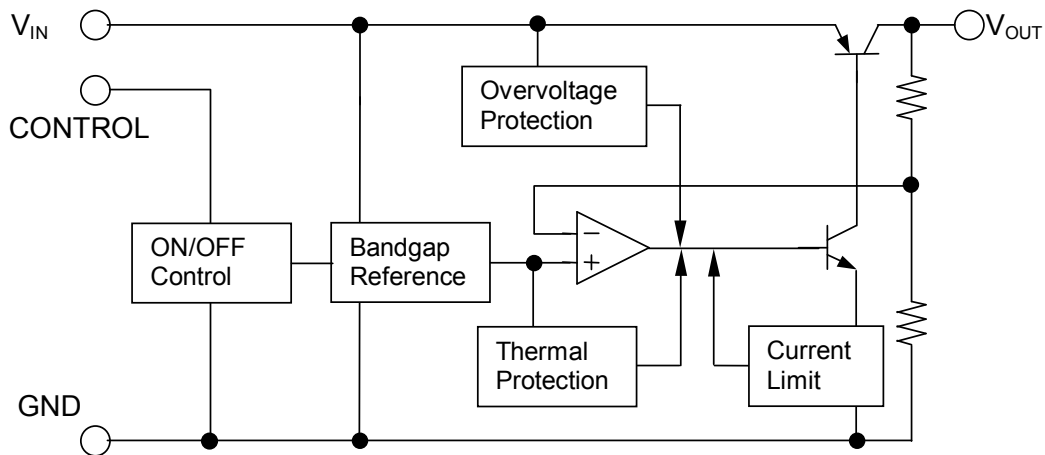

NJM2386/88

■ OUTPUT VOLTAGE RANK LIST

NJM2386DL3

NJM2388F

Device Name	V _{OUT}	Device Name	V _{OUT}
NJM2386DL3-33	3.3V	NJM2388F33	3.3V
NJM2386DL3-05	5.0V	NJM2388F05	5.0V
NJM2386DL3-63	6.3V	NJM2388F63	6.3V
NJM2386DL3-08	8.0V	NJM2388F08	8.0V
NJM2386DL3-09	9.0V	NJM2388F84	8.4V
NJM2386DL3-12	12.0V	NJM2388F09	9.0V
		NJM2388F10	10.0V
		NJM2388F12	12.0V

■ ABSOLUTE MAXIMUM RATINGS

(Ta=25°C)

PARAMETER	SYMBOL	RATINGS		UNIT
Input Voltage	V _{IN}	+35		V
Control Voltage	V _{CONT}	+35(*1)		V
Power Dissipation	P _D	NJM2386	1190(*2) / 3125(*3)	mW
		NJM2388	18(Tc<50°C)	W
Operating Junction Temperature Range	T _j	-40 ~ +150		°C
Operating Temperature Range	T _{opr}	-40 ~ +85		°C
Storage Temperature Range	T _{stg}	-50 ~ +150		°C

(*1): When input voltage is less than +35V, the absolute maximum control voltage is equal to the input voltage.

(*2): Mounted on glass epoxy board. (76.2 × 114.3 × 1.6mm:based on EIA/JDEC standard size, 2Layers, Cu area 100mm²)

(*3): Mounted on glass epoxy board. (76.2 × 114.3 × 1.6mm:based on EIA/JDEC standard, 4Layers)

(For 4Layers: Applying 74.2 × 74.2mm inner Cu area and a thermal via hole to a board based on JEDEC standard JESD51-5)

■ ELECTRICAL CHARACTERISTICS ($V_{IN}=V_O+1V$, $I_o=0.5A$, $C_{IN}=0.33\mu F$, $C_o=22\mu F$, $T_a=25^\circ C$)

Measurement is to be conducted is pulse testing.

PARAMETER	SYMBOL	CONDITIONS	MIN.	TYP.	MAX.	UNIT	
Output Voltage	V_o	$V_{IN}=V_O+1V$	-2%	-	+2%	V	
Line Regulation	$\Delta V_o/\Delta V_{IN}$	$V_{IN}=V_O+1V \sim V_O+17V$	-	0.04	0.16	%/V	
Load Regulation	$\Delta V_o/\Delta I_o$	$V_{IN}=V_O+2V, I_o=0A \sim 1.0A$	-	0.2	1.4	%/A	
Average Temperature Coefficient of Output Voltage	$\Delta V_o/\Delta T$	$T_j=0 \sim +125^\circ C$	-	± 0.02	-	%/°C	
Quiescent Current	I_Q	$I_o=0A$	-	-	5	mA	
Quiescent Current at Control OFF(*4)	$I_{Q(OFF)}$	$V_{CONT}=0V$	-	-	500	μA	
Dropout Voltage	ΔV_{LO}	$I_o=0.5A$	-	0.2	0.5	V	
Ripple Rejection	NJM238**33	RR	$V_{IN}=V_O+2V,$ $e_{in}=0.5V_{rms}, f=120Hz$	54	67	-	dB
	NJM238**05			54	67	-	
	NJM238**63			54	67	-	
	NJM238**08			52	65	-	
	NJM238**84			52	65	-	
	NJM238**09			52	65	-	
	NJM238**10			50	63	-	
	NJM238**12			50	63	-	
ON Control Voltage	$V_{CONT(ON)}$		2.0(*5)	-	-	V	
OFF Control Voltage	$V_{CONT(OFF)}$		-	-	0.4	V	
ON Control Current	$I_{CONT(ON)}$	$V_C=2.7V$	-	-	20	μA	
OFF Control Current	$I_{CONT(OFF)}$	$V_C=0.4V$	-	-	-20	μA	

(*4) This electrical characteristics is applied to NJM2388.

(*5): When ON/OFF CONTROL Terminal is open, Output Voltage is ON.

NJM2386/88

POWER DISSIPATION vs. AMBIENT TEMPERATURE

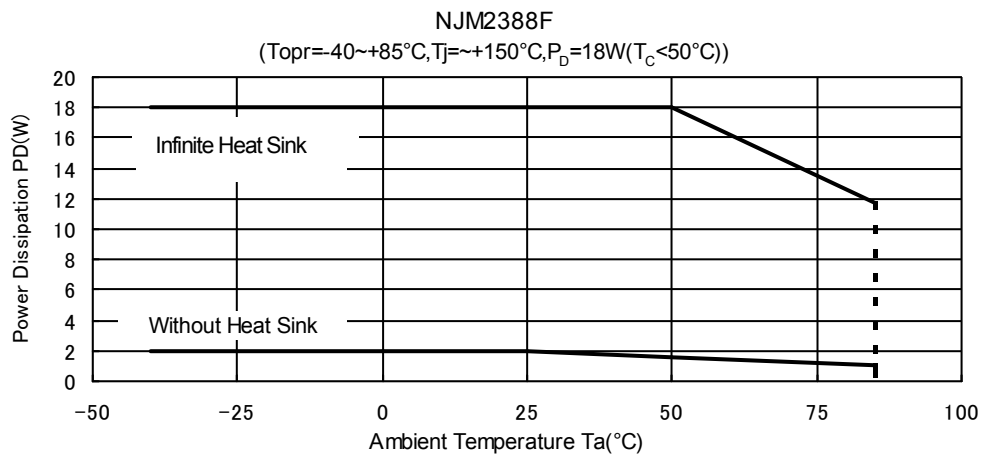
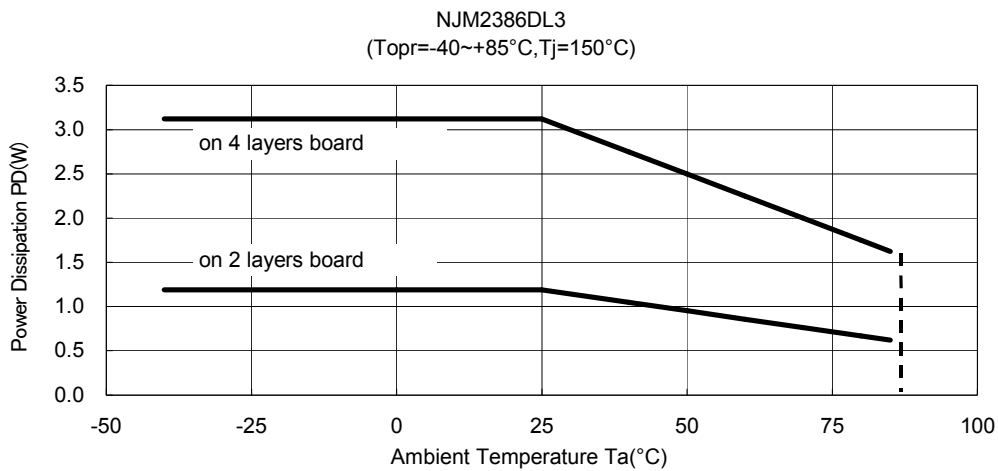

TEST CIRCUIT

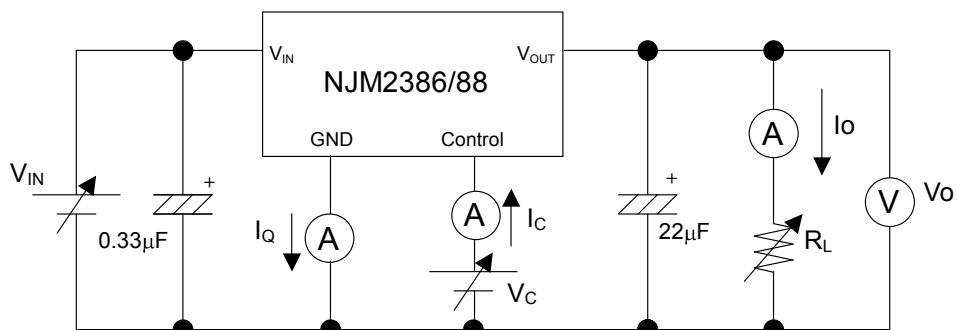

■ TYPICAL APPLICATION

① In the case where ON/OFF Control is not required:

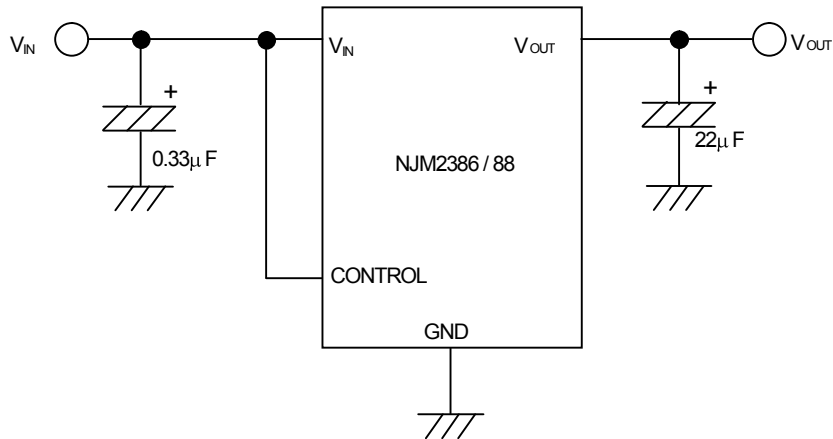

Connect control pin to V_{IN} pin or open.

② In use of ON/OFF CONTROL:

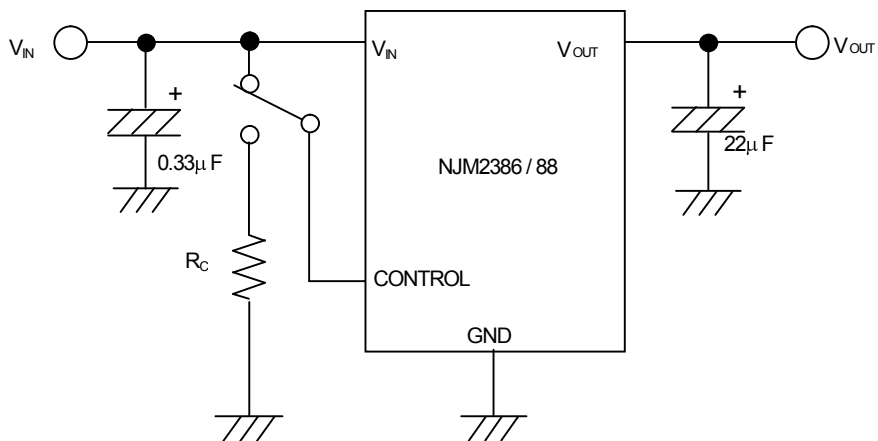

State of control pin:

- “H” or “open” → output is enabled.
- “L” → output is disabled.

*Input Capacitor C_{IN}

Input Capacitor C_{IN} is required to prevent oscillation and reduce power supply ripple for applications when high power supply impedance or a long power supply line.

Therefore, use the recommended C_{IN} value (refer to conditions of ELECTRIC CHARACTERISTIC) or larger and should connect between GND and V_{IN} as shortest path as possible to avoid the problem.

*Output Capacitor C_O

Output capacitor (C_O) will be required for a phase compensation of the internal error amplifier.

The capacitance and the equivalent series resistance (ESR) influence to stable operation of the regulator.

Use of a smaller C_O may cause excess output noise or oscillation of the regulator due to lack of the phase compensation.

On the other hand, Use of a larger C_O reduces output noise and ripple output, and also improves output transient response when rapid load change.

Therefore, use the recommended C_O value (refer to conditions of ELECTRIC CHARACTERISTIC) or larger and should connect between GND and V_{OUT} as shortest path as possible for stable operation

The recommended capacitance depends on the output voltage rank. Especially, low voltage regulator requires larger C_O value.

In addition, Please choose an appropriate capacitor in considering varied characteristics of capacitor (a frequency characteristic, a temperature characteristic, and so on) when selecting C_O .

TYPICAL CHARACTERISTICS

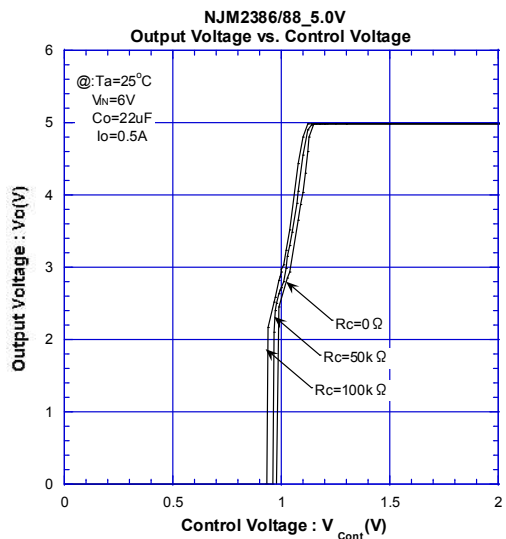
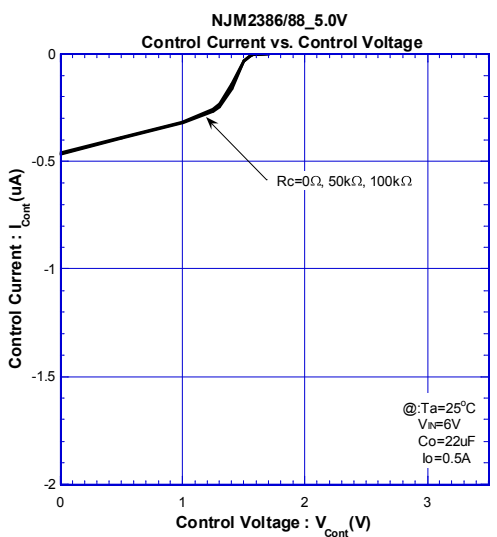
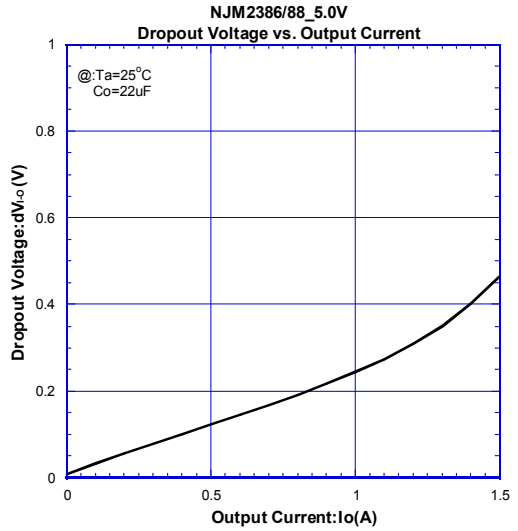
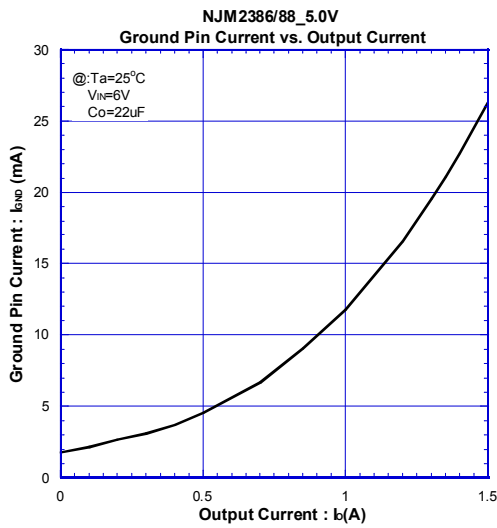
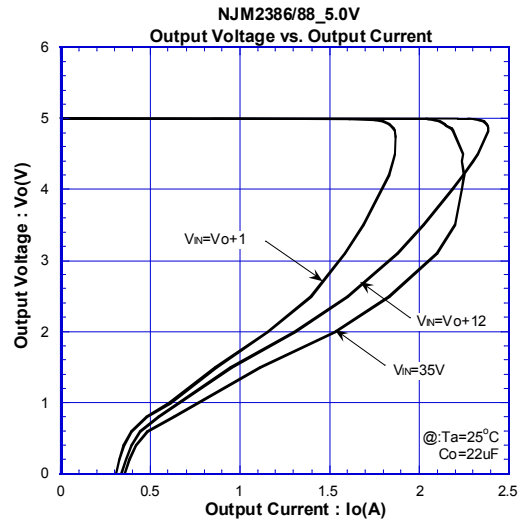
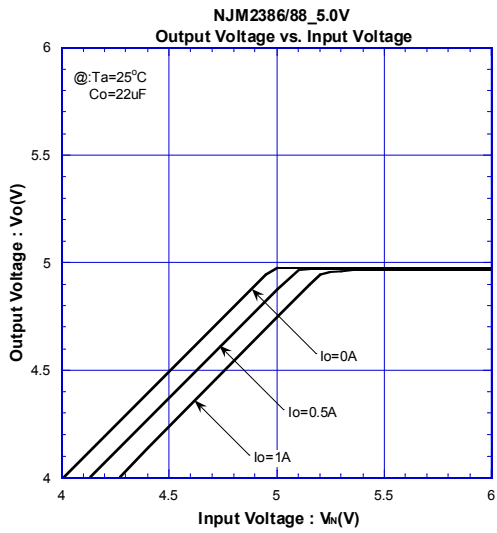

NJM2386/88

TYPICAL CHARACTERISTICS

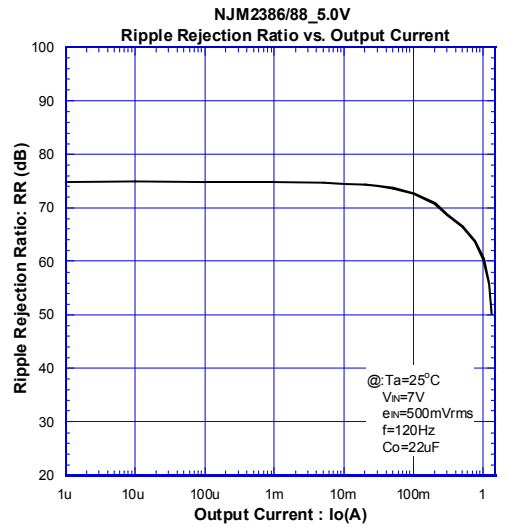
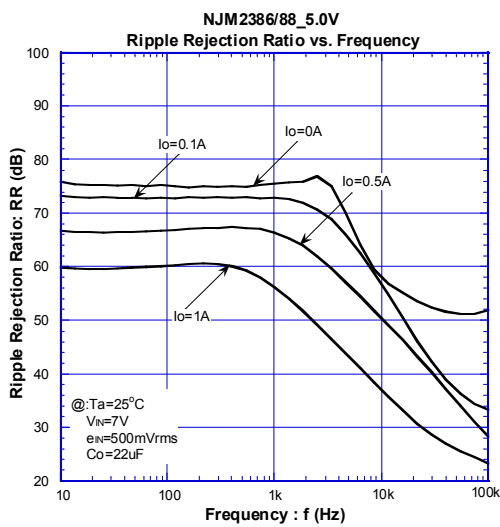
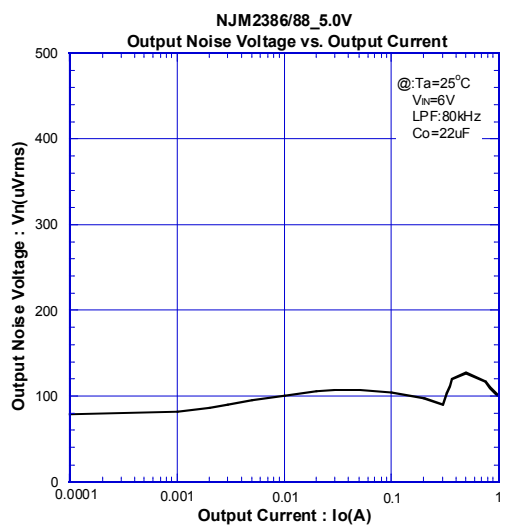
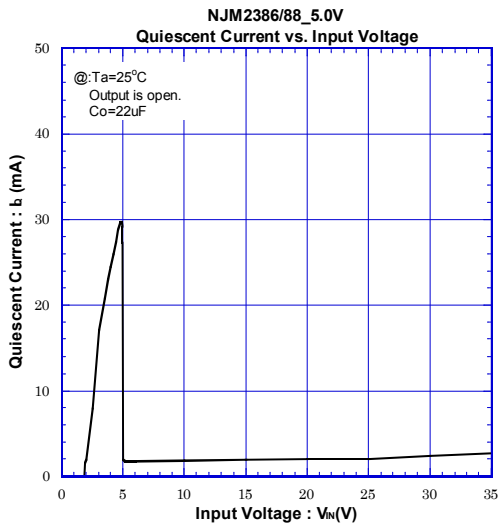
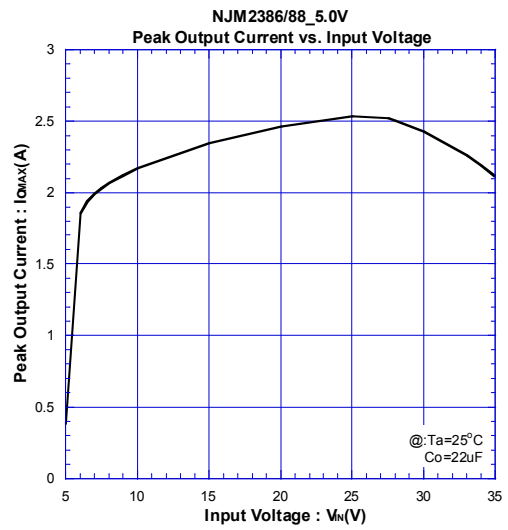
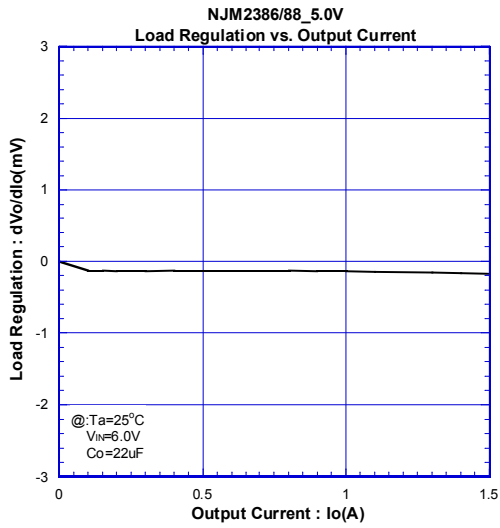

TYPICAL CHARACTERISTICS

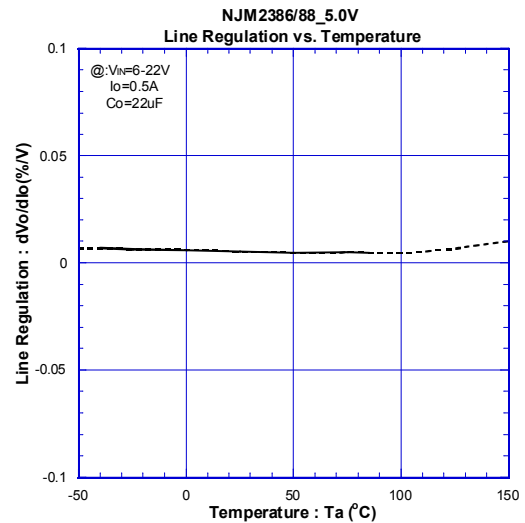
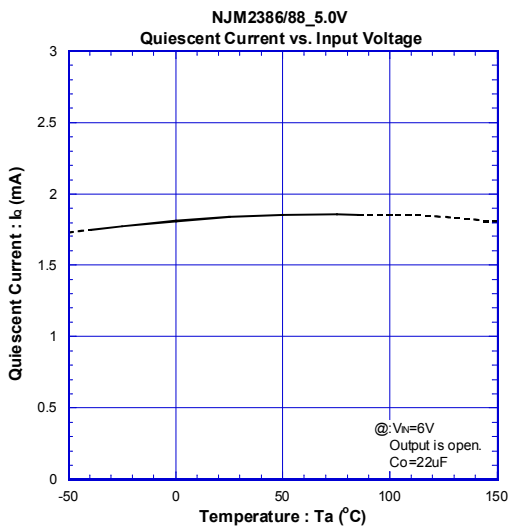
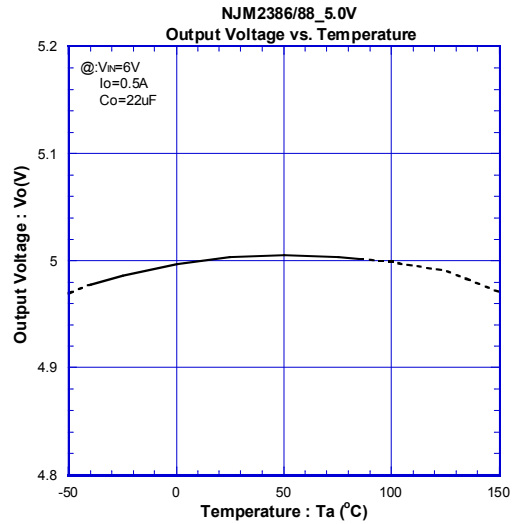
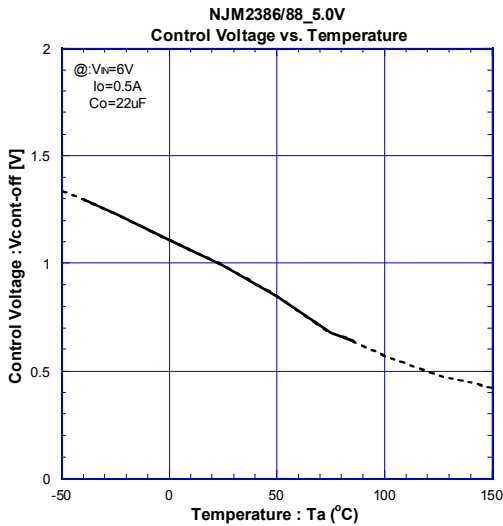
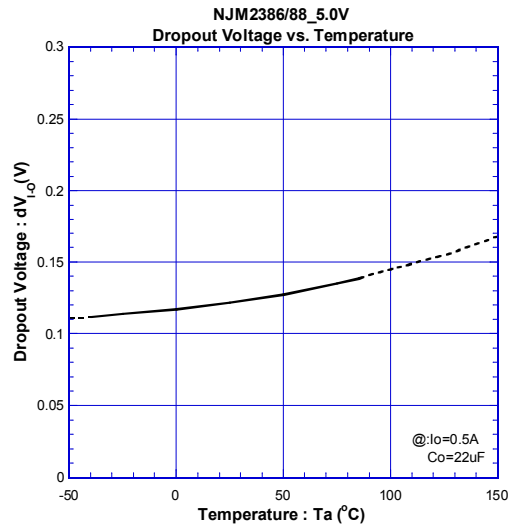
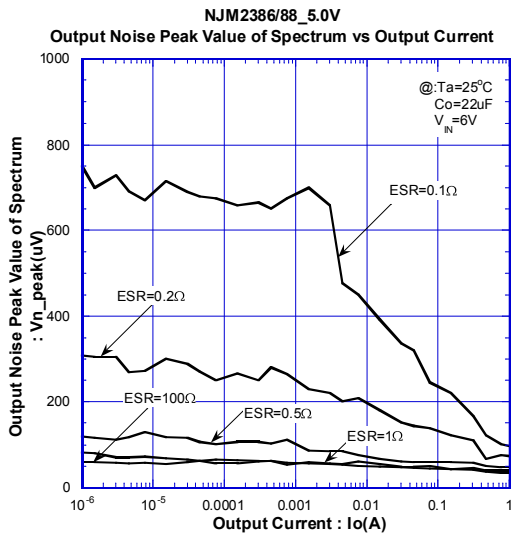

NJM2386/88

TYPICAL CHARACTERISTICS

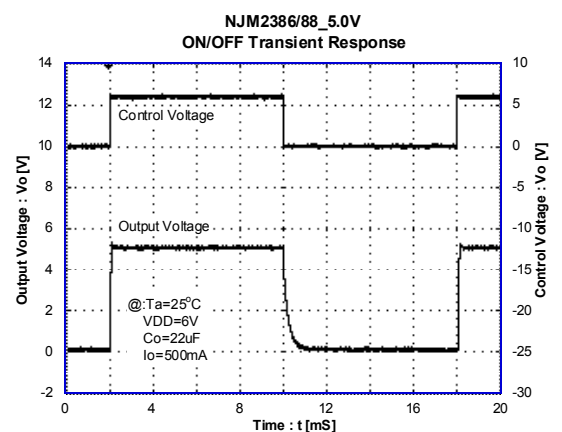
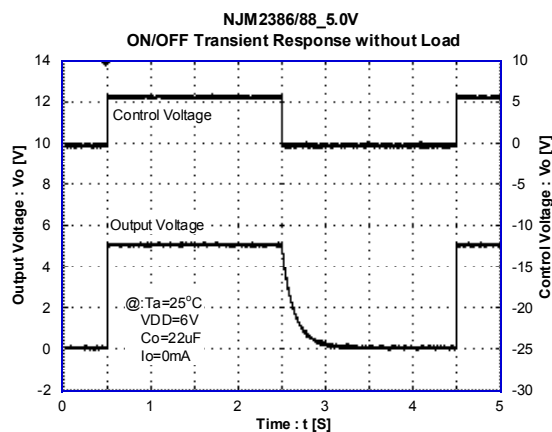
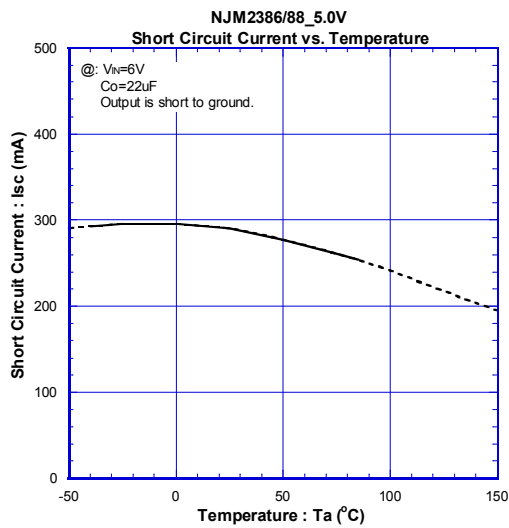
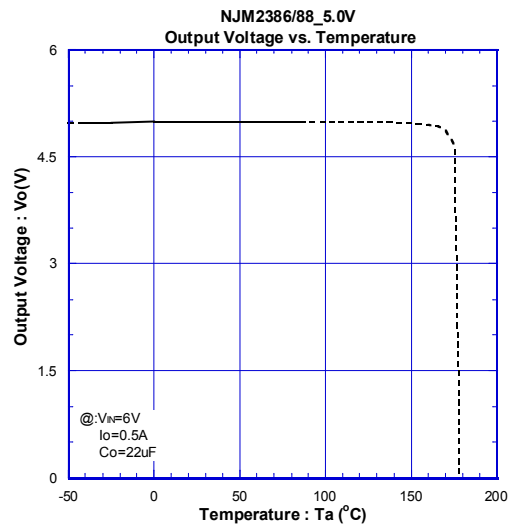
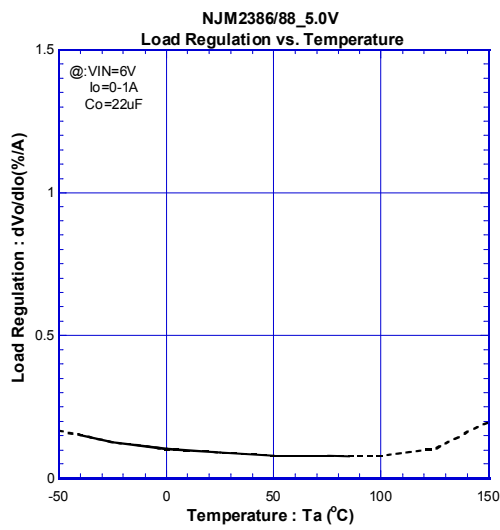

TYPICAL CHARACTERISTICS

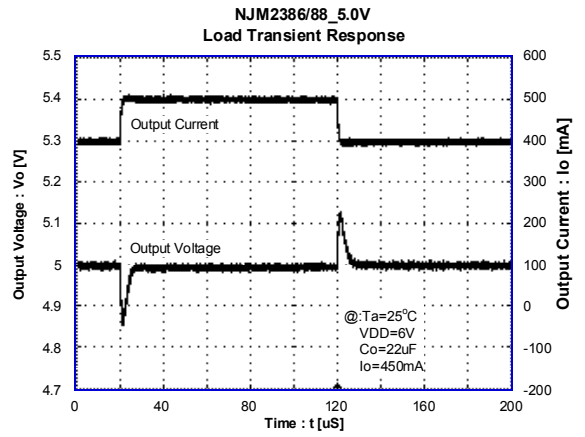
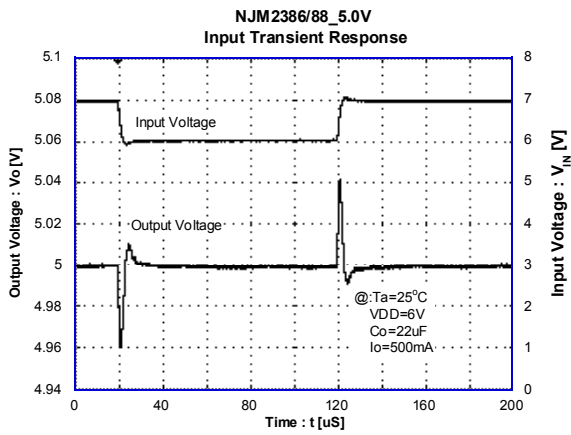

[CAUTION]

The specifications on this databook are only given for information, without any guarantee as regards either mistakes or omissions. The application circuits in this databook are described only to show representative usages of the product and not intended for the guarantee or permission of any right including the industrial rights.

Mouser Electronics

Authorized Distributor

Click to View Pricing, Inventory, Delivery & Lifecycle Information:

[NJR:](#)

[NJM2388F05](#) [NJM2388F12](#) [NJM2388F10](#) [NJM2388F08](#) [NJM2388F09](#) [NJM2388F63](#) [NJM2388F33](#) [NJM2388F84](#)