

REVISIONS

P	LTR	DESCRIPTION	DATE	DWN	APVD
	C1	Released as per ECR-08-022292	4-Sep-08	SP	JC
	Y	ECR-16-003725	12MAR2016	KR	TN

LASER MARKING: TE LOGO PN VALUE TOLERANCE & DATE CODE

2xØ2.4 HOLES

15.90±0.15

1.9 MIN

14.30±0.15

TAG HOLE Ø2/2.2

21 MAX

36.5 MAX

11 MAX

5.2±0.3

3.2 MAX

21 MAX

RoHS Compliant

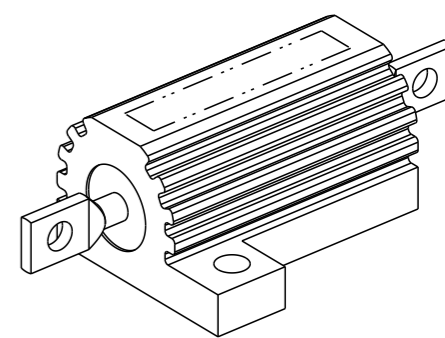

SCALE 2:1

1 FOR FURTHER INFORMATION SEE DATA SHEET FOR HS SERIES-ALUMINIUM HOUSED RESISTORS

2 FOR A SPECIFIC PN FOR A RESISTANCE VALUE AND TOLERANCE, PLEASE REFER TO DMF

3 TECHNICAL SPECIFICATION

DISSIPATION AT 25°C : 16 WATTS MOUNTED ON STANDARD HEATSINK

BS OHMIC RANGE : R051 TO 14K

STABILITY : ΔR < =1% PER 1000Hrs

ISOLATION VOLTAGE : 1400V DC/AC pk

MAX WORKING VOLTAGE : 250V DC/AC rms

TEMP COEFFICIENT : > 1R0 50ppm
> 100R 25ppm

CLIMATIC CATEGORY : 55/200/56

THIS DRAWING IS A CONTROLLED DOCUMENT.

DWN 15.AUG.02

DIMENSIONS:

mm

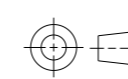

TOLERANCES UNLESS OTHERWISE SPECIFIED:

0 PLC	±0.5
1 PLC	±0.2
2 PLC	±0.1
3 PLC	±
4 PLC	±
ANGLES	±

MATERIAL

material_2

FINISH

finish_spec_2

CHK -

APVD -

PRODUCT SPEC -

APPLICATION SPEC -

WEIGHT -

CUSTOMER DRAWING

NAME HSA10 METAL CLAD RESISTOR

SIZE	CAGE CODE	DRAWING NO	RESTRICTED TO
------	-----------	------------	---------------

A3	00779	©=1625966	-
----	-------	-----------	---

SCALE	SHEET	OF	REV
4:1	1	1	Y



Mouser Electronics

Authorized Distributor

Click to View Pricing, Inventory, Delivery & Lifecycle Information:

[TE Connectivity:](#)

[HSA1010RJ](#)