

|            |             |         |                     |           |            |             |             |
|------------|-------------|---------|---------------------|-----------|------------|-------------|-------------|
| 版数<br>REV. | 年月日<br>DATE | DCN NO. | 変更内容<br>DESCRIPTION | 製図<br>DR. | 担当<br>CHK. | 査閲<br>APPD. | 承認<br>APPD. |
|------------|-------------|---------|---------------------|-----------|------------|-------------|-------------|

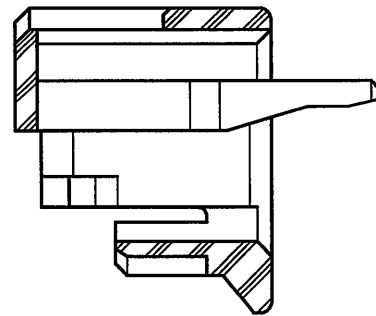

SECT. A-A  
(SCALE 5:1)

(MATERIAL MARK)

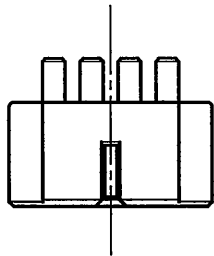
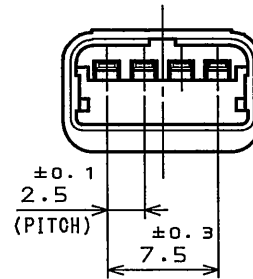
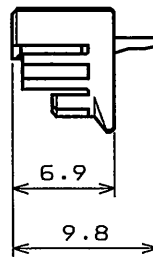
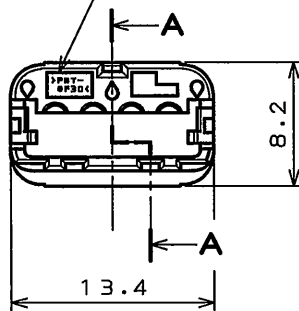

**特別管理品目**  
**SPECIAL CONTROL ITEM**  
**MX (SRS)**

DOF-0-211E(03.08)

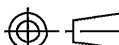
|   |   |                                   |                    |  |               |
|---|---|-----------------------------------|--------------------|--|---------------|
| 1   | FRONT RETAINER  | 1                                 | PBT-GF30           | —  | COLOR: BLACK  |
| 符号<br>NO.                                       | 名称<br>DESCRIPTION   | 個数<br>QTY.                        | 材料<br>MATERIAL     | 仕上<br>FINISH   | 備考<br>REMARKS |
| 仕様書 (SPECIFICATION)<br>JAOS-10220<br>JAHL-10220 |   | 第1版 (ORIGINAL DATE)<br>4.Feb.2005 |                    | 名称 (TITLE)<br>MX36004XF3   |               |
| 公差 (GENERAL TOLERANCE)                          |   | 製図<br>DR.                         | H.HASHIMOTO        | JAPAN AVIATION<br>ELECTRONICS<br>INDUSTRY, LTD.<br> |               |
| 寸法 (DIMENSION)                                  |   | 担当<br>CHK.                        | M.WATANABE         |  |               |
| 角度 (ANGLES)                                     |   | 査閲<br>APPD.                       | —                  |  |               |
|   |   | 承認<br>APPD.                       | A.Chino / Y.HIROSE |  |               |
| · ±0.8  | ×° ±  |                                   |                    | FRONT RETAINER   |               |
| ·X ±0.4   | ×°× ±   |                                   |                    | シリーズ (SERIES) 尺度 (SCALE)<br>MX36 2:1   |               |
| ·XX ±0.1  |  |                                   |                    | 図面番号 (DRAWING NO.)<br>SJ102923   |               |
| ·XXX ±  |   |                                   |                    | 版数 (REV.)<br>1   |               |

# Mouser Electronics

Authorized Distributor

Click to View Pricing, Inventory, Delivery & Lifecycle Information:

[JAE Electronics:](#)

[MX36004XF3](#)